

DYNAMIC ABUTMENT SOLUTIONS

DIGITAL SOLUTIONS

PRODUCT REFERENCES





Virginia Woolf, 17
25005 · Lleida (Spain)

INTERNATIONAL +34 873 450 709
das@dynamicabutment.com

SPAIN +34 973 289 580
spain@dynamicabutment.com

Dynamic Abutment Solutions is the trademark of the manufacturer Talladium España S.L The information included in this catalogue is exclusively addressed to professionals in dental sector.

All commercial trademarks mentioned herein are fully registered by their respective companies, and the images that appear are just to provide an orientation. Talladium reserves the right to modify this document without previous notice. Talladium is not responsible for the inadequate execution of these products if the warning indications corresponding to every reference are not contemplated.

Ask about the products available with CE legislation. Some of the products are not authorized for sale and distribution or do not have a sales license in some countries according to other legislations. Information: usa@dynamicabutment.com.



INDEX

5	LIST OF COMPATIBILITIES AVAILABLE
6	COMPATIBILITIES AVAILABLE
20	COMPATIBILITIES AND REFERENCES
160	DAS LIBRARIES
162	MULTI-UNIT DAS LIBRARIES
163	DYNAMIC SCREWS TECHNICAL SPECIFICATIONS
167	STRAIGHT SCREWS TECHNICAL SPECIFICATIONS
170	SCREWDRIVERS AND STRAIGHT SCREWS
171	DYNAMIC MILLING TOOL SPECIFICATIONS
174	SCREWDRIVERS AND COMPLEMENTS
175	DAS MU SYSTEM COMPONENTS

MULTI-UNIT DAS SYSTEM

DYNAMIC DAS SYSTEM

LIST OF COMPATIBILITIES AVAILABLE

AB	BIOTEC	ELITE MEDICA	JDENTALCARE	OSSTEM IMPLANT	TBR
ACE	BREDEENT MEDICAL	EUROTEKNIKA	KEYSTONE	OSTEOPLUS	TITANIUM-FIX
ADIN	BTI	F&B IMPLANT (FIT & BRILLIANT)	KLOCKNER	OXY	TREE-OSS
ALFA-GATE	BTK	GALIMPLANT	LASAK	PALTOP	TRI DENTAL IMPLANTS
ALPHABIO	CAMLOG	GC TECH	LEADER	PHIBO	TRINON
ANCLADEN	CONEXÃO SISTEMA DE PRÓTESE	GLOBAL D (TEKKA)	MEDENTIKA	PROCLINIC	UFIT
ANKYLOS	CORTEX	GMI (ILERIMPLANT)	MEDENTIS	RADHEX	VULKAN IMPLANTS
ANTHOGRYR	COWELLMEDI	GT MEDICAL	MEGAGEN	REFLECT	WIN
ARDS	C-TECH	HAHN IMPLANT (GLIDEWELL)	MICRODENT	ROOTT	XIVE
ASTRA	DENTAL TECH	HIOSSSEN	MIS	SEWON MEDIX	YES IMPLANT
AVINENT	DENTAURUM	HI-TEC	MOZO-GRAU (TICARE)	SIC INVENT	ZIACOM
B&W	DENTEGRIS	IBS	MPI	SIGNO VINCES	ZIMMER
BEGO	DENTIS	IDO IMPLANTS	NEOBIOTECH	SIN IMPLANTS	
BIOCONCEPT	DENTIUM	IHDE DENTAL (IMBIODENT)	NEODENT	SOUTHERN IMPLANTS	
BIOGENESIS	DIO IMPLANTS	IMPLANT DIRECT	NEOSS	STERI-OSS	
BIOHORIZONS	DMI DENTAL SUPPLY	IMPLANT GENESIS	NOBEL BIOCARE	STERNGOLD	
BIOLOK	DSP BIOMEDICAL	IMPLANTSWISS	NORIS MEDICAL	STRAUMANN	
BIOMET 3i	EASY IMPLANT	INTRA-LOCK	NORMON	SYBRON IMPLANT SOLUTIONS	
BIONER	ECKERMANN		NOVA IMPLANTS	SYSTHEX	

COMPATIBILITIES AVAILABLE

AB

Model: I2
Implant Ø: 3.5/3.75/4.2/4.5
Platform: Standard
Code: 0040

Model: I2
Implant Ø: 5/6
Platform: Standard
Code: 0040

Model: I22
Implant Ø: 3.75/4.22
Platform: Standard
Code: 0040

Model: I5
Implant Ø: 3.5/3.75/4.2/4.5
Platform: Standard
Code: 0040

Model: I5
Implant Ø: 5/6/7/8
Platform: Standard
Code: 0040

Model: I55
Implant Ø: 3.75/4.2/4.5
Platform: Standard
Code: 0040

Model: I55
Implant Ø: 5/6/7/8
Platform: Standard
Code: 0040

Model: I10
Implant Ø: 4.2/5
Platform: Standard
Code: 0040

Model: I15
Implant Ø: 6/7/8
Platform: Standard
Code: 0040

Model: Multi Unit D1-P64
Implant Ø: Multi Unit D1-P64
Platform: Universal
Code: 0025

ACE

Model: External Hex
Implant Ø: 3.3
Platform: NP 3.5
Code: 0023

Model: External Hex
Implant Ø: 3.75/4
Platform: RP 4.1
Code: 0024

Model: External Hex
Implant Ø: 4.75
Platform: WP 5
Code: 0058

Model: Infinity TRI-CAM
Implant Ø: 3.5
Platform: 3.5
Code: 0026

Model: Infinity TRI-CAM
Implant Ø: 4.3
Platform: 4.3
Code: 0027

Model: Infinity TRI-CAM
Implant Ø: 5
Platform: 5
Code: 0028

Model: Infinity Internal Hex
Implant Ø: 3.7/4.1
Platform: 3.5
Code: 0040

Model: Infinity Internal Hex
Implant Ø: 4.7/5.1
Platform: 4.5
Code: 0041

Model: Infinity Octagon
Implant Ø: 3.3
Platform: RP 4.8
Code: 0037

Model: Infinity Octagon
Implant Ø: 4.1
Platform: RP 4.8
Code: 0037

Model: Infinity Octagon
Implant Ø: 4.8
Platform: RP 4.8
Code: 0037

Model: Infinity Octagon
Implant Ø: 4.8
Platform: WP 6.5
Code: 0096

Model: Multi Unit
Implant Ø: Universal
Platform: Universal
Code: 0025

ADIN

Model: Swell
Implant Ø: 3.3
Platform: 3.45
Code: 0040

Model: Swell
Implant Ø: 3.3
Platform: 3.45
Code: 0042

Model: Swell
Implant Ø: 3.75/4.2
Platform: 3.6
Code: 0040

Model: Swell
Implant Ø: 3.75/4.2
Platform: 3.6
Code: 0042

Model: Swell
Implant Ø: 5
Platform: 4
Code: 0040

Model: Swell
Implant Ø: 5
Platform: 4
Code: 0042

Model: Swell
Implant Ø: 6
Platform: 4.6
Code: 0040

Model: Swell
Implant Ø: 6
Platform: 4.6
Code: 0042

Model: Touareg-S / Touareg-OS
Implant Ø: 3.5
Platform: 3.45
Code: 0040

Model: Touareg-S / Touareg-OS
Implant Ø: 3.5
Platform: 3.45
Code: 0042

Model: Touareg-S / Touareg-OS
Implant Ø: 3.75/4.2
Platform: 3.6
Code: 0040

Model: Touareg-S / Touareg-OS
Implant Ø: 3.75/4.2
Platform: 3.6
Code: 0042

Model: Touareg-S / Touareg-OS
Implant Ø: 5
Platform: 4
Code: 0040

Model: Touareg-S / Touareg-OS
Implant Ø: 5
Platform: 4
Code: 0042

Model: Touareg-S / Touareg-OS
Implant Ø: 6
Platform: 5
Code: 0040

Model: Touareg-S / Touareg-OS
Implant Ø: 6
Platform: 5
Code: 0042

Model: Touareg CloseFit
Implant Ø: 2.75
Platform: UNP
Code: 0188

Model: Touareg CloseFit
Implant Ø: 3
Platform:
Code: 0145

Model: Touareg CloseFit
Implant Ø: 3
Platform: NP
Code: 0145

Model: Touareg CloseFit
Implant Ø: 3.5
Platform: RP
Code: 0021

Model: Touareg CloseFit
Implant Ø: 4.3/5
Platform: WP
Code: 0022

Model: Triple
Implant Ø: 3.5/3.75/4.2/5/6
Platform: Standard
Code: 0040

Model: Triple
Implant Ø: 3.5/3.75/4.2/5/6
Platform: Standard
Code: 0042

Model: Multi Unit TMA
Implant Ø: Universal
Platform: Universal
Code: 0025

ALFA-GATE

Model: Bioactive S-line/SLA
Implant Ø: 3.3/3.75/4.2/4.7/5.2/6
Platform: 3.75
Code: 0040

Model: Conical
Implant Ø: 3.5
Platform: NP
Code: 0021

Model: Conical
Implant Ø: 4.3/5
Platform: RP
Code: 0022

ALPHABIO

Model: Internal Hex Connection (IH) SPI
Implant Ø: 3.3/3.75/4.2/5/6
Platform: Universal
Code: 0040

Model: Internal Hex Connection (IH) ICE
Implant Ø: 3.7/3.75/4.2/4.65/5.3
Platform: Universal
Code: 0040

Model: Internal Hex Connection (IH) DFI
Implant Ø: 3.3/3.75/4.2/5
Platform: Universal
Code: 0040

Model: Internal Hex Connection (IH) ATID
Implant Ø: 3.3/3.75/4.2/5/6
Platform: Universal
Code: 0040

Model: Internal Hex Connection (IH) NEO
Implant Ø: 3.75/4.2/5
Platform: 3.5
Code: 0040

Model: Conical Hex Connection (CHC) NICE
Implant Ø: 3.2
Platform: Narrow
Code: 0136

Model: Conical Hex Connection (CHC) NEO
Implant Ø: 3.2/3.5
Platform: Narrow
Code: 0136

Model: Conical Standard Connection (CS)
Implant Ø: 3.75/4.2/5
Platform: Standard
Code: 0169

Model: Multi Unit
Implant Ø:
Platform: Universal
Code: 0195

ANCLADEN

Model: Anclalock
Implant Ø: 3.75/4.25/5
Platform: 3.5
Code: 0040

ANKYLOS

Model: Ankylos
Implant Ø: 3.5
Platform: 3.5
Code: 0075

Model: Ankylos
Implant Ø: 4.5
Platform: 4.5
Code: 0075

Model: Ankylos
Implant Ø: 5.5
Platform: 5.5
Code: 0075

Model: Ankylos
Implant Ø: 7
Platform: 7
Code: 0075

Model: Balance Base Narrow
Implant Ø: Universal
Platform: Universal
Code: 0183

ANTHOGYR

Model: Axiom BL REG / PX
Implant Ø: 3.4
Platform: 3.4
Code: 0161

Model: Axiom BL REG / PX
Implant Ø: 4
Platform: 4
Code: 0149

Model: Axiom BL REG / PX
Implant Ø: 4.6
Platform: 4.6
Code: 0149

Model: Axiom BL REG / PX
Implant Ø: 5.2
Platform: 5.2
Code: 0162

Model: Anthofit HE
Implant Ø: 3.5/3.75/4
Platform: R (4.1)
Code: 0024

Model: Anthofit HE
Implant Ø: 5
Platform: L (5)
Code: 0058

Model: Ossfit
Implant Ø: 3.5/4.2
Platform: 4.8
Code: 0074

Model: Ossfit
Implant Ø: 3.5/4.2
Platform: 4.8
Code: 0037

Model: Ossfit
Implant Ø: 5
Platform: 6.5
Code: 0096

Model: Multi Unit
Implant Ø: 4.8
Platform: Universal
Code: 0163

ARDS

Model: Smart
Implant Ø: 3.75/4.2/4.5
Platform: 3.75
Code: 0040

Model: Classic
Implant Ø: 3.3/3.75/4.2/5/6
Platform: 3.75
Code: 0040

Model: Premium
Implant Ø: 3.3/3.75/4.2/5/6
Platform: 3.75
Code: 0040

Model: CIT
Implant Ø: 3.3/3.75/4.2/5/6
Platform: 3.75
Code: 0040

ASTRA

Model: Yellow
Implant Ø: 3
Platform: Yellow (X-estricha)
Code: 0109

Model: Aqua
Implant Ø: 3.5/4
Platform: Aqua (Estricha)
Code: 0004

Model: Lilac
Implant Ø: 4.5/5
Platform: Lilac (Ancha)
Code: 0005

Model: Uniabutment Cono 200
Implant Ø: Regular/Wide
Platform: Regular/Wide
Code: 0066

Model: Uniabutment Cono 450
Implant Ø: Regular/Wide
Platform: Regular/Wide
Code: 0067

Model: Evolution (Interno)
Implant Ø: 3.0
Platform: 3.0
Code: 0090

Model: Evolution (Interno)
Implant Ø: 3.6
Platform: 3.6
Code: 0006

Model: Evolution (Interno)
Implant Ø: 4.2
Platform: 4.2
Code: 0007

Model: Evolution (Interno)
Implant Ø: 4.8
Platform: 4.8
Code: 0091

Model: Evolution (Interno)
Implant Ø: 5.4
Platform: 5.4
Code: 0092

Model: Evolution (Cono externo 33°)
Implant Ø:
Platform: Universal
Code: 0008

Model: Multibase Abutment (SmartFix concept)
Implant Ø:
Platform: Universal
Code: 0258

AVINENT

Model: HE/EC
Implant Ø: 3.3/3.5/4
Platform: 3.5
Code: 0023

Model: HE/EC
Implant Ø:
3.3/3.8/4/4.2/4.8/4.5/5
Platform: 4.1
Code: 0024

Model: HE/EC
Implant Ø: 4.8
Platform: 5.1
Code: 0061

Model: HI/IC
Implant Ø: 3.1/3.5/4
Platform: 3.5
Code: 0040

Model: HI/IC
Implant Ø:
3.3/3.8/4/4.2/4.8/4.5/5
Platform: 4.1
Code: 0040

Model: Transepitelial
Implant Ø:
Platform: Regular
Code: 0025

B&W

Model: Hexágono Externo
Implant Ø: 3.75/4
Platform: 4.1
Code: 0024

Model: Hexágono Externo
Implant Ø: 5
Platform: 5
Code: 0058

Model: Cónico Hexagono Interno CIH
Implant Ø: 3.3/4
Platform: 4
Code: 0040

Model: Cónico Hexagono Interno CIH
Implant Ø: 3.3/4
Platform: 4
Code: 0042

BEGO

Model: RS/RSX
Implant Ø: 3.0
Platform: 3.0
Code: 0049

Model: S/RI/RS/RSX
Implant Ø: 3.25/3.75
Platform: 3.67
Code: 0050

Model: S/RI/RS/RSX
Implant Ø: 4.1
Platform: 4.1
Code: 0051

Model: S/RI/RS/RSX
Implant Ø: 4.5
Platform: 4.5
Code: 0052

Model: S/RI/RS/RSX
Implant Ø: 5.5
Platform: 5.5

Code: 0081
Model: Mini
Implant Ø: 2.7/2.9/3.1
Platform: Mini
Code: 0187

Model: MultiPlus
Implant Ø:
Platform: Universal
Code: 0150

COMPATIBILITIES AVAILABLE

BIOCONCEPT

Model: BC Tissue Level Standard
Implant Ø: 3.3/4.1/4.8
Platform: Regular
Code: 0037

Model: BC Tissue Level Standard Plus
Implant Ø: 4.8
Platform: Regular
Code: 0037

Model: BC Tissue Level Tapered Effect
Implant Ø: 4.8
Platform: Regular
Code: 0037

Model: BC Bone Level
Implant Ø: 3.3
Platform: Narrow
Code: 0033

Model: BC Bone Level
Implant Ø: 4.1/4.8
Platform: Regular
Code: 0035

Model: BV Tapered Bone Level
Implant Ø: 3.5
Platform: Narrow
Code: 0029

Model: BV Tapered Bone Level
Implant Ø: 4/4.5/5
Platform: Regular
Code: 0030

BIOGENESIS

Model: 3icon
Implant Ø: 3.3
Platform: Mini (Pink)
Code: 0023

Model: 3icon
Implant Ø: 3.75/4/4.3/4.5
Platform: Regular (Blue)
Code: 0024

Model: 3icon
Implant Ø: 5/5.5
Platform: Wide (Yellow)
Code: 0058

Model: Aticon
Implant Ø: 3.5/4/4.5/5
Platform: Blue
Code: 0005

Model: Aticon (Cono 45°)
Implant Ø: 4
Platform: Regular/Wide
Code: 0067

Model: Iticon
Implant Ø: 3.5/4/4.8
Platform: 4.8
Code: 0037

BIOHORIZONS

Model: External
Implant Ø: 3.5
Platform: 3.7 (Yellow)
Code: 0023

Model: Tapered Internal
Implant Ø: 3/3.4
Platform: 3 (Grey)
Code: 0102

Model: Tapered Internal
Implant Ø: 3.8
Platform: 3.5 (Yellow)
Code: 0040

Model: Tapered Internal
Implant Ø: 4.6
Platform: 4.5 (Green)
Code: 0041

Model: Tapered Internal
Implant Ø: 5.8
Platform: 5.7 (Blue)
Code: 0080

Model: Tapered Plus
Implant Ø: 3.8
Platform: 3 (Grey)
Code: 0102

Model: Tapered Plus
Implant Ø: 4.6
Platform: 3.5 (Yellow)
Code: 0040

Model: Tapered Plus
Implant Ø: 5.8
Platform: 4.5 (Green)
Code: 0041

Model: Mount-free Tapered Internal
Implant Ø: 3/3.4
Platform: 3 (Grey)
Code: 0102

Model: Mount-free Tapered Internal
Implant Ø: 3.8
Platform: 3.5 (Yellow)
Code: 0040

Model: Mount-free Tapered Internal
Implant Ø: 4.6
Platform: 4.5 (Green)
Code: 0041

Model: Mount-free Tapered Internal
Implant Ø: 5.8
Platform: 5.7 (Blue)
Code: 0080

Model: Tapered Pro
Implant Ø: 3.8
Platform: 3 (Grey)
Code: 0102

Model: Tapered Pro
Implant Ø: 4.2/4.6
Platform: 3.5 (Yellow)
Code: 0040

Model: Tapered Pro
Implant Ø: 5.2
Platform: 4.5 (Green)
Code: 0041

Model: Tapered Short
Implant Ø: 4.6
Platform: 3.5 (Yellow)
Code: 0040

Model: Tapered Short
Implant Ø: 5.8
Platform: 4.5 (Green)
Code: 0041

Model: Tapered PTG
Implant Ø: 4.2
Platform: 3.5 (Yellow)
Code: 0040

Model: Tapered IM (Immediate Molar)
Implant Ø: 7/8
Platform: 5.7 (Blue)
Code: 0080

Model: Tapered Tissue Level
Implant Ø: 3/3.8
Platform: 3.5 (Yellow)
Code: 0040

Model: Tapered Tissue Level
Implant Ø: 4.6
Platform: 4.5 (Green)
Code: 0041

Model: Tapered Tissue Level
Implant Ø: 5.8
Platform: 5.7 (Blue)
Code: 0080

Model: Multi Unit
Implant Ø: 3.8
Platform: Universal
Code: 0025

BIOLOK

Model: Hexágono Externo
Implant Ø: 3.45
Platform: 3.45
Code: 0003

BIOMET 3i

Model: Osseotite External Hex
Implant Ø: 3.25
Platform: 3.4
Code: 0003

Model: Osseotite External Hex
Implant Ø: 3.75/4
Platform: 4.1
Code: 0024

Model: Osseotite External Hex
Implant Ø: 5
Platform: 5
Code: 0058

Model: Osseotite External Hex
Implant Ø: 6
Platform: 6
Code: 0179

Model: Certain
Implant Ø: 3.25/4
Platform: 3.4
Code: 0001

Model: Certain
Implant Ø: 4/5
Platform: 4.1
Code: 0002

Model: Certain
Implant Ø: 5
Platform: 5
Code: 0057

Model: Low Profile
Implant Ø:
Platform: Universal
Code: 0025

BIONER

Model: Ikelt / Bikelt
Implant Ø: 3.3/3.75/4
Platform: 4.1
Code: 0024

Model: Ikelt
Implant Ø: 5
Platform: 5
Code: 0058

Model: Hikelt
Implant Ø: 3.8
Platform: 3.95
Code: 0040

Model: Hikelt
Implant Ø: 4.7
Platform: 4.9
Code: 0041

Model: TopDM
Implant Ø: 3.5
Platform: 3.5
Code: 0021

Model: TopDM
Implant Ø: 4
Platform: 4
Code: 0021

Model: TopDM
Implant Ø: 5
Platform: 5
Code: 0021

Model: Short DM
Implant Ø: 4/5/6
Platform: Universal
Code: 0021

Model: Hibikelt
Implant Ø: 4/5
Platform: Universal
Code: 0021

Model: Transepitelial A-5M
Implant Ø: 3.5/4/4.5
Platform: Regular
Code: 0025

BIOTEC

Model: SPR/CIM
Implant Ø: 3.3
Platform: 3.3
Code: 0040

Model: SPR/CIM
Implant Ø: 3.75
Platform: 3.75
Code: 0040

Model: SPR/SPTT/CIM
Implant Ø: 4.2
Platform: 4.2
Code: 0040

Model: SPR/SPTT/CIM
Implant Ø: 5
Platform: 5
Code: 0040

Model: SPR/CIM
Implant Ø: 3.3
Platform: 3.3
Code: 0040

BREDENT MEDICAL

Model: Narrow Sky
Implant Ø: 3.5
Platform: NP 3.5
Code: 0110

Model: Blue Sky
Implant Ø: 3.5/4/4.5/5.5
Platform: 4
Code: 0111

Model: Blue Sky Classic
Implant Ø: 3.5/4/4.5
Platform: 4
Code: 0111

Model: Copa Sky
Implant Ø: 3.5/4/4.5/5/6
Platform: 3.3
Code: 0251

BTI

Model: Externa Tiny
Implant Ø: 2.5/3/3.3/3.5/3.75
Platform: Tiny 3.5
Code: 0009

Model: Externa Universal
Implant Ø: 3.75/4
Platform: Universal 4.1
Code: 0024

Model: Externa Universal Plus
Implant Ø: 4.5/5
Platform: Universal Plus 4.1
Code: 0024

Model: Externa
Implant Ø: 4.5/5/5.5
Platform: Ancha 5.5
Code: 0060

Model: Interna
Implant Ø: 3.3/3.5/3.75
Platform: 3.5
Code: 0257

Model: Interna Universal
Implant Ø: 3.3/3.5/3.75/4/4.25
Platform: Universal 4.1
Code: 0010

Model: Interna Universal Plus
Implant Ø: 4.5/5/5.5
Platform: Universal Plus 4.1
Code: 0010

Model: Interna Ancha
Implant Ø: 5.5/6/6.25
Platform: Ancha 5.5
Code: 0059

Model: Multi-IM
Implant Ø: converter 4.1
Platform: Universal 4.1
Code: 0151

Model: Multi-IM
Implant Ø: converter 5.5
Platform: Ancha 5.5
Code: 0177

BTK

Model: Klassic / Konic
Implant Ø: 3.25
Platform: 3.4 EN
Code: 0003

Model: Klassic / Konic
Implant Ø: 3.25PL/3.75/4
Platform: 4.1 ER
Code: 0024

Model: IS +
Implant Ø: 3.3/3.7/4.1/4.8/6
Platform: DR
Code: 0029

Model: BT Safe BL
Implant Ø: 3.3/3.7/4.1/4.8
Platform: KR
Code: 0029

Model: Klassic / Konic
Implant Ø: 3.25/4
Platform: 3.5 IR
Code: 0040

Model: Klassic / Konic
Implant Ø: 3.25/4
Platform: 3.5 IR
Code: 0042

CAMLOG

Model: Camlog Screw-Line/Progressive-Line
Implant Ø: 3.3
Platform: 3.3
Code: 0087

Model: Camlog Screw-Line/Progressive-Line
Implant Ø: 3.8
Platform: 3.8
Code: 0011

Model: Camlog Screw-Line/Progressive-Line
Implant Ø: 4.3
Platform: 4.3
Code: 0012

Model: Camlog Screw-Line/Progressive-Line
Implant Ø: 5
Platform: 5
Code: 0088

Model: Camlog Screw-Line/Progressive-Line
Implant Ø: 6
Platform: 6
Code: 0089

Model: Conelog Screw-Line/Progressive-Line
Implant Ø: 3.3
Platform: 3.3
Code: 0119

Model: Conelog Screw-Line/Progressive-Line
Implant Ø: 3.8
Platform: 3.8
Code: 0120

Model: Conelog Screw-Line/Progressive-Line
Implant Ø: 4.3
Platform: 4.3
Code: 0121

Model: Conelog Screw-Line/Progressive-Line
Implant Ø: 5
Platform: 5
Code: 0122

CONEXÃO SISTEMA DE PRÓTESE

Model: Flash
Implant Ø: 3.5/4.3/5
Platform: Universal
Code: 0021

Model: Torq
Implant Ø: 3.5/3.75/4
Platform: Universal
Code: 0021

Model: Expand
Implant Ø: 3.75/4/5
Platform: Universal
Code: 0021

CORTEX

Model: Internal Hex Dynamix
Implant Ø: 3.3/3.8/4.2/5/6
Platform: 3.75
Code: 0040

Model: Internal Hex Classix
Implant Ø: 3.3/3.8/4.2/5/6
Platform: 3.75
Code: 0040

Model: Internal Hex Saturn
Implant Ø: 3.8/4.2
Platform: 3.5
Code: 0040

Model: Conical Dynamix
Implant Ø: 3
Platform: NP
Code: 0109

Model: Conical Dynamix
Implant Ø: 3.3/3.8/4.2
Platform: 3.5 IR
Code: 0004

Model: Conical Dynamix
Implant Ø: 5/6
Platform: WP
Code: 0005

Model: Conical Classix
Implant Ø: 3.3/3.8/4.2
Platform: RP
Code: 0004

Model: Conical Classix
Implant Ø: 5/6
Platform: WP
Code: 0005

Model: Conical Magix
Implant Ø: 3.3/3.8/4.2
Platform: RP
Code: 0004

Model: Multi Unit
Implant Ø:
Platform: Universal
Code: 0025

COWELLMEDI

Model: Inno - External Type
Implant Ø: 5.0/6.0
Platform: 5.1
Code: 0061

Model: Multi S&A Abutment Ø 4.5 mm
Implant Ø: Multi S Abutment
Platform: Universal
Code: 0193

C-TECH

Model: EL Esthetic Line
Implant Ø: 3.8/4.3/5.1
Platform: 4
Code: 0246

Model: Multi Unit
Implant Ø:
Platform: Universal
Code: 0245

DENTAL TECH

Model: Implagic
Implant Ø: 4.5
Platform: 4.5 (Blue)
Code: 0041

COMPATIBILITIES AVAILABLE

DENTAURUM

Model: Tiologic
Implant Ø: 3.3
Platform: Small
Code: 0130

Model: Tiologic
Implant Ø: 3.7/4.2
Platform: Medium
Code: 0131

Model: Tiologic
Implant Ø: 4.8/5.5
Platform: Large
Code: 0132

Model: Tiolox
Implant Ø: 3.5
Platform: 3.5
Code: 0133

Model: Tiolox
Implant Ø: 4.5
Platform: 4.5
Code: 0134

DENTEGRIS

Model: SLS-Straight
Implant Ø: 4.5
Platform: 4.5
Code: 0041

Model: Sinus-Lift
Implant Ø: 4.5
Platform: 4.5
Code: 0041

Model: S&T Implants
Implant Ø: 4.5
Platform: 4.5
Code: 0041

DENTIS

Model: OneQ-SL
Implant Ø: 3
Platform: Narrow
Code: 0014

Model: OneQ-SL
Implant Ø: 3.9/4.2/4.7/5.2
Platform: Regular
Code: 0030

Model: OneQ-SL
Implant Ø: 6/7/8
Platform: Wide
Code: 0030

Model: s-Clean Tapered /
Tapered II
Implant Ø: 3.7
Platform: Mini
Code: 0030

Model: s-Clean Tapered /
Tapered II
Implant Ø: 4.1/4.3
Platform: Regular
Code: 0030

Model: s-Clean Tapered /
Tapered II
Implant Ø: 4.8
Platform: Wide
Code: 0030

Model: s-Clean Straight
Implant Ø: 4.1/4.8
Platform: 4.1/4.8
Code: 0030

Model: s-Clean Save
Implant Ø: 5.5/6
Platform: 5.5/6
Code: 0030

Model: SQ-SL
Implant Ø: 3.5
Platform: Narrow
Code: 0014

Model: SQ-SL
Implant Ø: 4.4/5/5
Platform: Regular
Code: 0030

Model: SQ-SL
Implant Ø: 6/7/8
Platform: Wide
Code: 0030

Model: e-Clean
Implant Ø: 4.1
Platform: Mini
Code: 0023

Model: e-Clean
Implant Ø: 4.1
Platform: Regular
Code: 0024

Model: e-Clean
Implant Ø: 5.1
Platform: Wide
Code: 0061

Model: i-Clean Tapered
Implant Ø: 3.7
Platform: Mini
Code: 0037

Model: i-Clean Tapered
Implant Ø: 4.1/4.3
Platform: Regular
Code: 0037

Model: i-Clean Tapered
Implant Ø: 4.8
Platform: Wide
Code: 0037

Model: i-Clean Straight
Implant Ø: 4.1/4.8
Platform: 4.8
Code: 0037

Model: Octa Abutment
Implant Ø: 3.75/4.5/5.3
Platform: Universal
Code: 0074

DENTIUM

Model: NR Line
Implant Ø: 3.1
Platform: 3.2
Code: 0190

Model: NR Line
Implant Ø: 3.1
Platform: 3.6
Code: 0190

Model: NR Line
Implant Ø: 3.6
Platform: 3.6
Code: 0191

Model: NR Line
Implant Ø: 4.3
Platform: 4.3
Code: 0191

Model: NR Line
Implant Ø: 5
Platform: 5
Code: 0191

Model: NR Line
Implant Ø: 6
Platform: 6
Code: 0191

Model: Multi Unit NR Line
Implant Ø:
Platform: 5
Code: 0192

Model: SimpleLine II
Implant Ø: 3.8/4.3
Platform: 4.8
Code: 0074

Model: SimpleLine II
Implant Ø: 3.8/4.3
Platform: 4.8
Code: 0037

Model: SimpleLine II
Implant Ø: 4.3/4.8
Platform: 6.5
Code: 0096

Model: SuperLine/SuperLine
II/Implantium
Implant Ø: 3.4
Platform: 3.6
Code: 0030

Model: SuperLine/SuperLine
II/Implantium
Implant Ø: 3.8
Platform: 4
Code: 0030

Model: SuperLine/SuperLine
II/Implantium
Implant Ø: 4.3
Platform: 4.5
Code: 0030

Model: SuperLine/SuperLine
II/Implantium
Implant Ø: 4.8
Platform: 5
Code: 0030

Model: SuperLine/SuperLine
II/Implantium
Implant Ø: 4.8
Platform: 6
Code: 0030

Model: Multi Unit Superline and
Implantium
Implant Ø:
Platform: 4.5
Code: 0193

DIO IMPLANTS

Model: SM System
Implant Ø: 4.5/5/5.3
Platform: Regular/Wide
Code: 0013

Model: UF II Narrow
Implant Ø: 3/3.3
Platform: Narrow
Code: 0014

Model: UF II
Implant Ø: 3.8/4/4.5/5/5.5
Platform: Regular
Code: 0030

Model: External
Implant Ø: 3.3/3.8
Platform: Narrow 3.5
Code: 0023

Model: External
Implant Ø: 3.75/4/4.5
Platform: Regular 4.1
Code: 0024

Model: External
Implant Ø: 5/5.3/5.5/6
Platform: Wide 5.1
Code: 0061

Model: Internal OCTA
Implant Ø:
Platform: 4.8
Code: 0074

Model: Multi Unit
Implant Ø:
Platform: Universal
Code: 0247

DMI DENTAL SUPPLY

Model: DCI/DSI
Implant Ø: 3.3/3.5/3.75/4.2/5/6
Platform: 3.75
Code: 0040

DSP BIOMEDICAL

Model: Hexágono Externo
Implant Ø: 3.75/4/5//3.5/3.8/4.3
Platform: 4.1
Code: 0024

EASY IMPLANT

Model: Master C
Implant Ø: 3.5 (Ocean)
Platform: 3.5 (Ocean)
Code: 0004

Model: Master C
Implant Ø: 4 (Ocean)
Platform: 4 (Ocean)
Code: 0004

Model: Master C
Implant Ø: 4.5 (Lilas)
Platform: 4.5 (Lilas)
Code: 0030

Model: Master C
Implant Ø: 5 (Lilas)
Platform: 5 (Lilas)
Code: 0030

Model: Master S
Implant Ø: 3.3 (Ocean)
Platform: 3.3 (Ocean)
Code: 0004

Model: Master S
Implant Ø: 3.75 (Lilas)
Platform: 3.75 (Lilas)
Code: 0030

Model: Master S
Implant Ø: 4.25 (Lilas)
Platform: 4.25 (Lilas)
Code: 0030

Model: Master S
Implant Ø: 4.75 (Lilas)
Platform: 4.75 (Lilas)
Code: 0030

Model: Master L
Implant Ø: 3.3 (Lilas)
Platform: 3.3 (Lilas)
Code: 0030

Model: Master L
Implant Ø: 3.75 (Lilas)
Platform: 3.75 (Lilas)
Code: 0030

Model: Master L
Implant Ø: 4.25 (Lilas)
Platform: 4.25 (Lilas)
Code: 0030

Model: Master L
Implant Ø: 4.75 (Lilas)
Platform: 4.75 (Lilas)
Code: 0030

Model: MINI
Implant Ø: 3
Platform: 3
Code: 0176

Model: Hexcel-S
Implant Ø: 3.3
Platform: 3.3
Code: 0003

Model: Hexcel-S
Implant Ø: 3.75
Platform: 4.1
Code: 0024

Model: Hexcel-S
Implant Ø: 4.25
Platform: 4.1
Code: 0024

Model: Hexcel-S
Implant Ø: 4.75
Platform: 5
Code: 0058

Model: Multi Unit Conical
Abutment
Implant Ø:
Platform: Universal
Code: 0025

COMPATIBILITIES AVAILABLE

ECKERMANN

Model: All-Spiral
Implant Ø: 4
Platform: Regular
Code: 0069

Model: Duplo
Implant Ø: 4
Platform: Regular
Code: 0070

Model: Hexagon
Implant Ø: 3/3.5/4/4.5/5
Platform: 4.1
Code: 0024

Model: Winner
Implant Ø: 3/3.5/4
Platform: 3.5
Code: 0040

Model: Winner
Implant Ø: 3/3.5/4
Platform: 3.5
Code: 0042

Model: Winner
Implant Ø: 4/4.5/5
Platform: 4.5
Code: 0041

Model: Winner
Implant Ø: 4/4.5/5
Platform: 4.5
Code: 0043

ELITE MEDICA

Model: Conexión Externa
Implant Ø: 3.75
Platform: Narrow
Code: 0023

Model: Conexión Externa
Implant Ø: 4
Platform: Regular
Code: 0024

Model: Conexión Externa
Implant Ø: 5
Platform: Wide
Code: 0061

EUROTEKNIKA

Model: Naturactis
Implant Ø: 3.5
Platform: 3.4
Code: 0004

Model: Naturactis
Implant Ø: 4
Platform: 3.8
Code: 0004

Model: Naturactis
Implant Ø: 4.5
Platform: 4.3
Code: 0004

Model: Naturactis
Implant Ø: 5
Platform: 4.8
Code: 0004

Model: Uneva
Implant Ø: 3.6
Platform: 4.1
Code: 0024

Model: Uneva (Platform
Switching)
Implant Ø: 4.8
Platform: 4.1
Code: 0024

Model: Uneva (Platform
Switching)
Implant Ø: 6
Platform: 4.1
Code: 0024

Model: Conexión Externa
Implant Ø: 5
Platform: Universal
Code: 0004

Model: Natea
Implant Ø: 3.6/4.1/4.8
Platform: Narrow
Code: 0004

Model: Natea
Implant Ø: 3.6/4.1/4.8
Platform: Regular
Code: 0004

Model: Natea
Implant Ø: 6
Platform: Wide
Code: 0004

Model: Aesthetica
Implant Ø: 4.1
Platform: 4.8
Code: 0074

Model: Aesthetica
Implant Ø: 4.8
Platform: 4.8
Code: 0037

Model: Aesthetica
Implant Ø: 4.8
Platform: 6.5
Code: 0096

Model: Naturall
Implant Ø: 3.5
Platform: Narrow
Code: 0004

Model: Naturall
Implant Ø: 4/4.5
Platform: Regular
Code: 0004

Model: Naturall
Implant Ø: 5
Platform: Wide
Code: 0004

Model: Ibone E/Ibone S
Implant Ø: 3.8/4.3/4.8
Platform: 3.5
Code: 0004

Model: Ibone E/Ibone S
Implant Ø: 4.8/5.5/6.2
Platform: 4.3
Code: 0004

Model: Ibone G
Implant Ø: 4.8/5.5
Platform: RP
Code: 0037

Model: Ibone G
Implant Ø: 6
Platform: W/P
Code: 0096

Model: Multi Unit Tetra
Implant Ø: 4.1
Platform: Universal
Code: 0025

F&B IMPLANT (FIT & BRILLIANT)

Model: FA Submerged Fixture
Implant Ø: 3.9
Platform: Narrow
Code: 0030

Model: FA Submerged Fixture
Implant Ø: 4.1/4.4
Platform: Regular
Code: 0030

Model: FA Submerged Fixture
Implant Ø: 4.8
Platform: Wide
Code: 0030

Model: FA Submerged Fixture
Implant Ø: 5.3/5.8/6.3/6.8
Platform: Ultra-Wide
Code: 0030

GALIMPLANT

Model: Conexión Externa
Implant Ø: 3.5/4
Platform: 4
Code: 0024

COMPATIBILITIES AVAILABLE

Model: Conexión Interna
Implant Ø: 3.5
Platform: 3.5
Code: 0004

Model: Conexión Interna
Implant Ø: 4
Platform: 4
Code: 0004

Model: Conexión Interna
Implant Ø: 5
Platform: 5
Code: 0004

Model: Pilar multi-posicion
recto/Pilar multi-posicion
angulado
Implant Ø: Universal
Platform: Universal
Code: 0025

GC TECH

Model: AADVA Standard /
Tapered Implants
Implant Ø: 3.3
Platform: Narrow
Code: 0196

Model: AADVA Standard /
Tapered Implants
Implant Ø: 4
Platform: Regular
Code: 0197

Model: AADVA Standard /
Tapered Implants
Implant Ø: 5
Platform: Wide
Code: 0198

GLOBAL D (TEKKA)

Model: In-Kone Universal
Implant Ø: 3.5/4/4.5/5
Platform: Universal
Code: 0152

Model: In-Kone Primo
Implant Ø: 3.5/4/4.5/5
Platform: Universal
Code: 0152

GMI (ILERIMPLANT)

Model: Avantgard
Implant Ø: 3.75/4.25
Platform: RP
Code: 0243

Model: Phoenix
Implant Ø: 3.3/3.75/4
Platform: Standard 4.1
Code: 0024

Model: Phoenix
Implant Ø: 5
Platform: Wide 5.1
Code: 0061

Model: Frontier
Implant Ø: 3.3/3.75/4.25
Platform: RP 3.3
Code: 0040

Model: Frontier
Implant Ø: 4.75/5.75
Platform: WP 4.3
Code: 0041

Model: Universal
Implant Ø: Universal
Platform: PS-RP 4.8
Code: 0025

GT MEDICAL

Model: Best Fit Octógono Interno
Implant Ø: 3.7/4.3/4.8
Platform: Regular
Code: 0074

Model: Best Fit Octógono Interno
Implant Ø: 3.7/4.3/4.8
Platform: Regular
Code: 0037

Model: Best Fit Hexágono Interno
Implant Ø: 3.7/4.1/4.3/4.8
Platform: Wide
Code: 0005

Model: Best Fit Hexágono Externo
Implant Ø: 3.5
Platform: Narrow
Code: 0023

Model: Best Fit Hexágono Externo
Implant Ø: 4.1
Platform: Regular
Code: 0024

Model: Best Fit Hexágono Externo
Implant Ø: 5.1
Platform: Wide
Code: 0061

HAHN IMPLANT (GLIDEWELL)

Model: Hahn Tapered Implant
Implant Ø: 3.5/4.3
Platform: 3.5/4.3
Code: 0021

Model: Hahn Tapered Implant
Implant Ø: 5
Platform: 5
Code: 0022

Model: Hahn Tapered Implant
Implant Ø: 7
Platform: 7
Code: 0124

Model: Multi-Unit Abutment
system
Implant Ø: Universal
Platform: Universal
Code: 0025

HIOSSEN

Model: ETIII SA / ETIII SA
Implant Ø: 3.5
Platform: Mini
Code: 0029

Model: ETIII SA / ETIII SA / ETIV
SA
Implant Ø: 4/4.5/5
Platform: Regular
Code: 0030

Model: ETIII BA
Implant Ø: 3.5
Platform: Mini
Code: 0029

Model: ETIII BA
Implant Ø: 4/4.5/5
Platform: Regular
Code: 0030

HI-TEC

Model: Tapered Self Thread
Implant Ø: 3.3/3.75
Platform: 3.5
Code: 0040

Model: Tapered Self Thread
Implant Ø: 4.2/5
Platform: 4.5
Code: 0041

Model: Logic Plus
Implant Ø: 3.5
Platform: 3.7
Code: 0040

Model: Logic Plus
Implant Ø: 4.3
Platform: 3.4
Code: 0040

IBS

Model: Magic FC
Implant Ø: 4/4.5/5/5.5/6/6.5
Platform: 3.8
Code: 0030

Model: N.R. Fix
Implant Ø: 3/3.5
Platform: 3.8
Code: 0030

IDO IMPLANTS

Model: I Do Implant
Implant Ø: 3.8/4/4.5/5/5.5/6/7
Platform: Universal
Code: 0030

IHDE DENTAL (IMBIODENT)

Model: Bone Level Plus
Implant Ø: 3.3
Platform: 3.3
Code: 0033

Model: Bone Level Plus
Implant Ø: 4.1
Platform: 4.1
Code: 0035

Model: Bone Level Plus
Implant Ø: 4.8
Platform: 4.8
Code: 0035

IMPLANT DIRECT

Model: RePlus / Replant /
Reactive
Implant Ø: 3.5/3.7/4.2
Platform: 3.5
Code: 0026

Model: RePlus / Replant /
Reactive
Implant Ø: 4.3/4.7
Platform: 4.3
Code: 0027

Model: RePlus / Replant /
Reactive
Implant Ø: 5/5.7
Platform: 5
Code: 0028

Model: Legacy
Implant Ø: 3.7/4.2
Platform: 3.5
Code: 0040

Model: Legacy
Implant Ø: 4.7/5.2
Platform: 4.5
Code: 0041

Model: Swishplant / Swishplus
Implant Ø: 4.1/4.8
Platform: 4.8
Code: 0074

Model: Swishplant / Swishplus
Implant Ø: 4.1/4.8
Platform: 4.8
Code: 0037

Model: Swishplant / Swishplus
Implant Ø: 4.8/5.7
Platform: 6.5
Code: 0096

Model: SwishActive
Implant Ø: 3.3
Platform: 3
Code: 0021

Model: SwishActive
Implant Ø: 4.1/4.8
Platform: 3.4
Code: 0022

Model: Interactive
Implant Ø: 3.2/3.7
Platform: 3
Code: 0021

Model: Interactive
Implant Ø: 4.3/5
Platform: 3.4
Code: 0022

Model: Simply Iconic
Implant Ø: 3.2/3.7/4.2
Platform: Purple 3.0
Code: 0021

Model: Simply Iconic
Implant Ø: 4.7/5.2/5.7
Platform: Gold 3.4
Code: 0022

IMPLANT GENESIS

Model: Aktiv System
Implant Ø: 3.5/3.75/4.2/5
Platform: Standard
Code: 0040

IMPLANTSWISS

Model: Bone Level
Implant Ø: 3.3
Platform: 3.3
Code: 0004

Model: Bone Level
Implant Ø: 3.7
Platform: 3.7
Code: 0030

Model: Bone Level
Implant Ø: 4.3
Platform: 4.3
Code: 0030

Model: Bone Level
Implant Ø: 4.8
Platform: 4.8
Code: 0030

Model: Bone Level
Implant Ø: 5.5
Platform: 5.5
Code: 0030

Model: Multi Unit Abutment
Implant Ø: Universal
Platform: 4.8
Code: 0025

INTRA-LOCK

Model: Unihex
Implant Ø: 4
Platform: Regular
Code: 0024

Model: Unihex
Implant Ø: 4.75
Platform: Wide
Code: 0024

Model: IntraHex
Implant Ø: 3.5/3.75/4
Platform: 3.5
Code: 0040

Model: IntraHex
Implant Ø: 4.75
Platform: 4.5
Code: 0041

JDENTALCARE

Model: JDEvolution/JDEvolution
Plus
Implant Ø: 3.7
Platform: 3.7
Code: 0040

Model: JDEvolution/JDEvolution
Plus
Implant Ø: 4.3/5
Platform: 4
Code: 0040

Model: JDEvolution/JDEvolution
Plus
Implant Ø: 6
Platform: 5
Code: 0040

Model: JD Pterygo
Implant Ø: 4
Platform: 4
Code: 0040

Model: JD ICON
Implant Ø: 3.9
Platform: 3.9
Code: 0022

Model: JD ICON
Implant Ø: 4.3
Platform: 4
Code: 0022

Model: JD ICON
Implant Ø: 5
Platform: 4.7
Code: 0022

Model: JD ICON Plus
Implant Ø: 3.7
Platform: 3.7
Code: 0015

Model: JD ICON Plus
Implant Ø: 4.3
Platform: 4
Code: 0015

Model: JD ICON Plus
Implant Ø: 5
Platform: 4.8
Code: 0015

Model: JD ICON Plus T
Implant Ø: 3.5
Platform: 3.5
Code: 0015

Model: JD ICON Plus T
Implant Ø: 4
Platform: 3.5
Code: 0015

Model: JD ICON Plus T
Implant Ø: 4.5
Platform: 3.5
Code: 0015

Model: Conical Abutment
Implant Ø:
Platform: Universal
Code: 0025

KEYSTONE

Model: Restore
Implant Ø: 3.75/4
Platform: RD 4.1
Code: 0024

Model: Restore
Implant Ø: 5/6
Platform: WD 5
Code: 0061

Model: Internal TiLobe
PrimaConnex
Implant Ø: 3.3/3.5
Platform: 3.5
Code: 0044

Model: Internal TiLobe
PrimaConnex
Implant Ø: 4/4.1
Platform: 4.1
Code: 0045

Model: Internal TiLobe
PrimaConnex
Implant Ø: 5
Platform: 5
Code: 0046

Model: Internal TiLobe Prima Plus
Implant Ø: 3.5
Platform: 3.5
Code: 0044

Model: Internal TiLobe Prima Plus
Implant Ø: 4.1
Platform: 4.1
Code: 0045

Model: Internal TiLobe Prima Plus
Implant Ø: 5/6
Platform: 5
Code: 0046

KLOCKNER

Model: NK2-SK2
Implant Ø: 3.3/3.8/4.2
Platform: 4.2
Code: 0062

Model: Essential Cone
Implant Ø: 3.5/4/4.5
Platform: 4.5
Code: 0054

Model: Essential Cone
Implant Ø: 4.8
Platform: 6
Code: 0071

Model: Essential Cone Pilar 25°
Implant Ø: 3.5/4/4.5
Platform: 4.5
Code: 0054

Model: Essential Cone Octacone
12°
Implant Ø: 3.5/4/4.5
Platform: 4.5
Code: 0054

Model: KL
Implant Ø: 3.3
Platform: Narrow
Code: 0023

Model: KL
Implant Ø: 3.7/4.2
Platform: Regular
Code: 0024

Model: KL
Implant Ø: 4.7
Platform: Wide
Code: 0061

Model: S3M
Implant Ø: 3.1
Platform: 3.3
Code: 0053

Model: Vega
Implant Ø: 3
Platform: MV
Code: 0180

Model: Vega
Implant Ø: 3.5
Platform: NV
Code: 0082

Model: Vega
Implant Ø: 4/4.5
Platform: RV
Code: 0083

Model: Vega+
Implant Ø: 3.6
Platform: NV
Code: 0082

Model: Vega+
Implant Ø: 4.1/4.6
Platform: RV
Code: 0083

Model: Multi Unit Permanent
Implant Ø: 4.2
Platform: Universal
Code: 0173

LASAK

Model: Bioniq
Implant Ø: 2.9
Platform: QR (Amarillo)
Code: 0166

Model: Bioniq
Implant Ø: 3.5
Platform: QR (Azul)
Code: 0167

Model: Bioniq
Implant Ø: 4
Platform: QR (Azul)
Code: 0167

COMPATIBILITIES AVAILABLE

Model: Bioniq
Implant Ø: 3.75
Platform: QR (Azul)
Code: 0167

Model: Multi Unit
Implant Ø: 4.1
Platform: Universal
Code: 0168

LEADER

Model: Tixos Internal Hex
Implant Ø: 3.3
Platform: 3.5
Code: 0040

Model: Tixos Internal Hex
Implant Ø: 3.75
Platform: 4
Code: 0040

Model: Tixos External Hex
Implant Ø: 3.3/3.75
Platform: 4.1
Code: 0024

Model: Tixos External Hex
Implant Ø: 5
Platform: 5
Code: 0058

MEDENTIKA

Model: Multi Unit
Implant Ø:
Platform: Universal
Code: 0025

MEDENTIS

Model: Premium/Active Master
Implant Ø: 3.3
Platform: 3.3 (Pink)
Code: 0249

Model: Premium/Active Master
Implant Ø: 3.75
Platform: 3.75 (Red)
Code: 0125

Model: Premium/Active Master
Implant Ø: 4.1
Platform: 4.1 (Green)
Code: 0125

Model: Premium/Active Master
Implant Ø: 4.8
Platform: 4.8 (Blue)
Code: 0125

MEGAGEN

Model: AnyRidge
Implant Ø: 3.5
Platform: Small
Code: 0015

Model: AnyRidge
Implant Ø: 4/4.5
Platform: Regular
Code: 0015

Model: AnyRidge
Implant Ø: 5/5.5
Platform: Wide
Code: 0015

Model: AnyOne Internal
Implant Ø: 3.5/4/4.5/5/6/7
Platform: General
Code: 0030

Model: AnyOne External
Implant Ø: 3.5
Platform: Small 3.5
Code: 0023

Model: AnyOne External
Implant Ø: 4
Platform: Regular 4.1
Code: 0024

Model: AnyOne External
Implant Ø: 4.5
Platform: Regular 4.5
Code: 0024

Model: AnyOne External
Implant Ø: 5
Platform: Wide 5
Code: 0058

Model: AnyOne External
Implant Ø: 6
Platform: SuperWide 5.5
Code: 0058

Model: Cone Abutment
Implant Ø: Universal
Platform: 3.8
Code: 0128

Model: Cone Abutment
Implant Ø: Universal
Platform: 4.8
Code: 0074

Model: Mini Narrow Ridge
Implant Ø: 3/3.4
Platform: Mini
Code: 0014

Model: ExFeel
Implant Ø: 3.5
Platform: Small
Code: 0037

Model: ExFeel
Implant Ø: 4.1
Platform: Regular
Code: 0037

Model: ExFeel
Implant Ø: 4.8/5
Platform: Wide
Code: 0037

Model: Multi Unit N Type
Implant Ø: Multi Unit N Type
Platform: Universal
Code: 0025

Model: Multi Unit S Type
Implant Ø: Multi Unit S Type
Platform: Universal
Code: 0264

MICRODENT

Model: Universal
Implant Ø: 2.8/3.25
Platform: 3.5
Code: 0003

Model: Universal
Implant Ø: 3.3/3.5/3.75/4
Platform: 4.1
Code: 0024

Model: Universal
Implant Ø: 4.2/5
Platform: 5.1
Code: 0058

Model: System
Implant Ø: 2.8/3.25
Platform: 3.5
Code: 0003

Model: System
Implant Ø: 3.3/3.5/3.8/4.2
Platform: 4.2
Code: 0062

Model: System
Implant Ø: 4.2/5
Platform: 5.1
Code: 0062

Model: Ektos
Implant Ø: 3.7/4.2
Platform: 3.5
Code: 0040

MIS

Model: Lance
Implant Ø: 3.75/4.2
Platform: Standard
Code: 0024

Model: Lance
Implant Ø: 5
Platform: Wide
Code: 0058

Model: Multi-Unit
Implant Ø:
Platform: General
Code: 0020

Model: Seven
Implant Ø: 3.3
Platform: Narrow
Code: 0019

Model: Seven
Implant Ø: 3.75/4.2
Platform: Standard
Code: 0040

Model: Seven
Implant Ø: 5/6
Platform: Wide
Code: 0041

Model: M4
Implant Ø: 3.3
Platform: Narrow
Code: 0019

Model: M4
Implant Ø: 3.75/4.2
Platform: Standard
Code: 0040

Model: M4
Implant Ø: 5/6
Platform: Wide
Code: 0041

Model: C1
Implant Ø: 3.3
Platform: Narrow
Code: 0016

Model: C1
Implant Ø: 3.75/4.2
Platform: Standard
Code: 0017

Model: C1
Implant Ø: 5
Platform: Wide
Code: 0018

Model: V3
Implant Ø: 3.9/4.3/5
Platform: Standard
Code: 0017

MOZO-GRAU (TICARE)

Model: MG Osseous
Implant Ø: 3.3
Platform: 3.4 Mini
Code: 0003

Model: MG Osseous
Implant Ø: 3.4/3.75/4.25
Platform: 4.1 Standard
Code: 0024

Model: MG Osseous
Implant Ø: 5
Platform: 5 Maxi
Code: 0061

Model: MG Inhex
Implant Ø:
Platform: Con 450
Code: 0067

Model: MG Inhex
Implant Ø: 3.3
Platform: 2.3 Mini
Code: 0109

Model: MG Inhex
Implant Ø: 3.75/4.25
Platform: 2.8 Standard
Code: 0004

Model: MG Inhex
Implant Ø: 5
Platform: 3.8 Maxi
Code: 0005

MPI

Model: Conexión Externa HE
Privilege
Implant Ø: 3.3
Platform: 3.5
Code: 0009

Model: Conexión Externa HE
Privilege
Implant Ø: 3.3/4
Platform: 4.1
Code: 0024

Model: Conexión Externa HE
Privilege
Implant Ø: 5
Platform: 5
Code: 0058

Model: Privilege CM
Implant Ø: 3.5/4
Platform: Regular
Code: 0004

Model: Privilege CM
Implant Ø: 5
Platform: Wide
Code: 0005

Model: Excellence CM
Implant Ø: 3.5/4
Platform: Regular
Code: 0004

Model: Excellence CM
Implant Ø: 5
Platform: Wide
Code: 0005

NEOBIOTECH

Model: EB External System
Implant Ø: 3.5
Platform: Narrow
Code: 0023

Model: IS Implant System
Implant Ø: 3.2
Platform: S-Narrow
Code: 0029

Model: IS Implant System
Implant Ø: 3.5
Platform: Narrow
Code: 0030

Model: IS Implant System
Implant Ø: 4
Platform: Regular
Code: 0030

Model: IS Implant System
Implant Ø: 4.5
Platform: Regular
Code: 0030

Model: IS Implant System
Implant Ø: 5
Platform: Wide
Code: 0030

Model: IS Implant System
Implant Ø:
Platform: 4.8
Code: 0025

NEODENT

Model: Helix GM/Drive
GM/Titamax GM
Implant Ø: 3.5/3.75/4/4.3/5/6
Platform: Regular
Code: 0186

Model: Smart HE
Implant Ø: 3.75/4
Platform: 4.1
Code: 0024

Model: Helix HE
Implant Ø: 3.75/4/4.3
Platform: 4.1
Code: 0024

COMPATIBILITIES AVAILABLE

Model: Mini Pilar CM / Mini Pilar
Angulado CM
Implant Ø: Mini Pilar CM / Mini
Pilar Angulado CM
Platform: Universal
Code: 0025

NEOSS

Model: ProActive
Straight/Tapered/Edge
Implant Ø: 3.25 Royal Blue
Platform: 3.25
Code: 0144

Model: ProActive
Straight/Tapered/Edge
Implant Ø: 3.5 Green
Platform: Standard
Code: 0047

Model: ProActive
Straight/Tapered/Edge
Implant Ø: 4.5 Yellow
Platform: Standard
Code: 0047

Model: ProActive
Straight/Tapered/Edge
Implant Ø: 4.5 Blue
Platform: Standard

Code: 0048
Model: ProActive
Straight/Tapered/Edge
Implant Ø: 5 Peach
Platform: Standard
Code: 0048

Model: ProActive
Straight/Tapered/Edge
Implant Ø: 5.5 Lilac
Platform: Standard
Code: 0048

Model: ProActive Wide
Implant Ø: 6
Platform: Standard
Code: 0048

Model: ProActive Sinus
Implant Ø: 6.5
Platform: Standard
Code: 0048

Model: Short Implant
Implant Ø: 3.5/4/4.5
Platform: Standard
Code: 0047

Model: Short Implant
Implant Ø: 5/5.5/6/6.5
Platform: Standard
Code: 0048

NOBEL BIOCARE

Model: Branemark
Implant Ø: 3.3
Platform: Narrow
Code: 0023

Model: Branemark
Implant Ø: 3.75/4
Platform: Regular
Code: 0024

Model: Branemark
Implant Ø: 5/6
Platform: Wide
Code: 0061

Model: Multi-Unit
Implant Ø: Regular
Platform: Regular
Code: 0025

Model: Multi-Unit
Implant Ø: Wide
Platform: Wide
Code: 0068

Model: Standard
Implant Ø:
Platform: Regular
Code: 0077

Model: Replace
Implant Ø: 3.5
Platform: Narrow
Code: 0026

Model: Replace
Implant Ø: 4.3
Platform: Regular
Code: 0027

Model: Replace
Implant Ø: 5
Platform: Wide
Code: 0028

Model: Replace
Implant Ø: 6
Platform: Platform 6
Code: 0129

Model: Active/Replace Conical
Connection
Implant Ø: 3
Platform: Mini 3.0
Code: 0159

Model: Active/Replace Conical
Connection
Implant Ø: 3.5
Platform: Narrow
Code: 0021

Model: Active/Replace Conical
Connection
Implant Ø: 4.3/5
Platform: Regular
Code: 0022

Model: Active/Replace Conical
Connection
Implant Ø: 5.5
Platform: Wide
Code: 0124

Model: NobelSpeedy
Implant Ø: 3.3
Platform: Narrow
Code: 0023

Model: NobelSpeedy
Implant Ø: 4/5
Platform: Regular
Code: 0024

Model: NobelSpeedy
Implant Ø: 5/6
Platform: Wide
Code: 0061

Model: NobelParallel
Implant Ø: 3.75
Platform: Narrow
Code: 0021

Model: NobelParallel
Implant Ø: 4.3/5
Platform: Regular
Code: 0022

Model: NobelParallel
Implant Ø: 5.5
Platform: Wide
Code: 0124

NORIS MEDICAL

Model: Tuff
Implant Ø: 3.3/3.75/4.2/5/6
Platform: 3.75
Code: 0040

Model: Tuff TT
Implant Ø: 3.3/3.75/4.2/5/6
Platform: 3.75
Code: 0040

Model: Onix
Implant Ø: 3.3/3.75/4.2/5/6
Platform: 3.75
Code: 0040

Model: Cortical
Implant Ø: 4.0/5/6
Platform: 3.75
Code: 0040

COMPATIBILITIES AVAILABLE

Model: PteryCore
Implant Ø: 4.2
Platform: 3.75
Code: 0040

Model: PteryFit
Implant Ø: 4.2
Platform: 3.75
Code: 0040

NORMON

Model: Normoimplant HE
Implant Ø: 3.25/3.75/4.25/4.75
Platform: 4.1
Code: 0024

Model: Normoimplant HI
Implant Ø: 3.75/4.25/4.75
Platform: 3.5
Code: 0040

NOVA IMPLANTS

Model: PSI/PCI
Implant Ø: 3.3/3.75/4.2/5/6
Platform: 3.75
Code: 0040

OSSTEM IMPLANT

Model: TS
Implant Ø: 3.5
Platform: Mini 3.5
Code: 0029

Model: TS
Implant Ø: 4.4/5/5/6/7
Platform: Regular
Code: 0030

Model: US
Implant Ø: 3.3/3.5
Platform: Mini 3.5
Code: 0023

Model: US
Implant Ø: 3.75/4/4.5
Platform: Regular 4.1
Code: 0024

Model: US
Implant Ø: 5/5.5
Platform: Wide 5.1
Code: 0061

Model: US
Implant Ø: 5/5.5
Platform: Wide PS 5
Code: 0058

OSTEOPLUS

Model: Argentium
Implant Ø: 3.8/4.2/4.8
Platform: 4.2
Code: 0062

Model: Iridium
Implant Ø: 3.8/4.2/4.8
Platform: 4.2
Code: 0062

Model: Platinum
Implant Ø: 4.5
Platform: 4.2
Code: 0062

Model: She
Implant Ø: 3.45
Platform: 3.45
Code: 0009

Model: She
Implant Ø: 3.75/4
Platform: 4
Code: 0024

Model: Shi
Implant Ø: 3.3 / 3.75 / 4.2
Platform: 3.5
Code: 0040

OXY

Model: K1 Line
Implant Ø: 3.5/4/4.5/5
Platform: Regular
Code: 0015

Model: K1 Line
Implant Ø: 5.5/6/6.5
Platform: Wide
Code: 0015

Model: PSK Line
Implant Ø: 3.5/4/4.5/5
Platform: Regular
Code: 0015

Model: MD Line KONE
Implant Ø: 3.75/4.25/5
Platform: Regular
Code: 0015

Model: MD Line Ext
Implant Ø: 3.75/4.25
Platform: Standard
Code: 0024

PALTOP

Model: Advanced classic
Implant Ø: 3.25
Platform: Narrow (blue)
Code: 0229

Model: Advanced classic
Implant Ø: 3.75/4.2/5
Platform: Standard
Code: 0040

Model: Advanced classic
Implant Ø: 3.75/4.2/5
Platform: Standard
Code: 0042

Model: Advanced classic
Implant Ø: Wide (purple)
Code: 0041

Model: Advanced +
Implant Ø: 3.25
Platform: Narrow (blue)
Code: 0229

Model: Advanced +
Implant Ø: 3.75/4.2/5
Platform: Standard
Code: 0040

Model: Advanced +
Implant Ø: 3.75/4.2/5
Platform: Standard
Code: 0042

Model: Advanced +
Implant Ø: 6
Platform: Wide (purple)
Code: 0041

Model: Dynamic
Implant Ø: 3.25
Platform: Narrow (blue)
Code: 0229

Model: Dynamic
Implant Ø: 3.75/4.2/5
Platform: Standard
Code: 0040

Model: Dynamic
Implant Ø: 3.75/4.2/5
Platform: Standard
Code: 0042

Model: Dynamic
Implant Ø: 6
Platform: Wide (purple)
Code: 0041

Model: PAI
Implant Ø: 3.25
Platform: Narrow (blue)
Code: 0229

Model: PAI
Implant Ø: 3.75/4.2/5
Platform: Standard
Code: 0040

Model: PAI
Implant Ø: 3.75/4.2/5
Platform: Standard
Code: 0042

Model: PAI
Implant Ø: 6
Platform: Wide (Purple)
Code: 0041

Model: DIVA/ACTIVE
Implant Ø: 3.75/4.2/5
Platform: Standard
Code: 0040

Model: DIVA/ACTIVE
Implant Ø: 3.75/4.2/5
Platform: Standard
Code: 0042

Model: Conical Active
Implant Ø: 3.25/3.75/4.2/5
Platform: Standard
Code: 0029

Model: Universal Multi-Unit
Implant Ø: Multi-Unit
Platform: Universal
Code: 0181

Model: Universal Single-Unit
Implant Ø: Single-Unit
Platform: Universal
Code: 0182

PHIBO

Model: TSA Serie 3
Implant Ø: 3.6
Platform: 3.7
Code: 0072

Model: TSA Serie 4
Implant Ø: 4.2
Platform: 4.7
Code: 0073

Model: TSA Serie 5
Implant Ø: 5.5
Platform: 6
Code: 0073

Model: TSH/BNT Serie 3
Implant Ø: 3.6
Platform: 4
Code: 0024

Model: TSH/BNT Serie 4
Implant Ø: 4.2
Platform: 4
Code: 0024

Model: TSH/BNT Serie 5
Implant Ø: 4.8
Platform: 5
Code: 0060

PROCLINIC

Model: Cilindrico Externo
Implant Ø: 3.3
Platform: 3.3 Mini
Code: 0009

Model: Cilindrico Externo/Cónico Externo
Implant Ø: 3.75/4.25/3.5/4
Platform: 4.1 Estandar
Code: 0024

Model: Cilindrico Externo/Cónico Externo
Implant Ø: 5
Platform: 5 Maxi
Code: 0058

Model: Cilindrico Interno/Cónico Interno
Implant Ø: 3.3/3.75/4.25/5/3.5/4/5
Platform: 3.5
Code: 0040

Model: SP Octa
Implant Ø: 3.3/4.1/4.8
Platform: 4.8
Code: 0074

Model: SP Octa
Implant Ø: 3.3/4.1/4.8
Platform: 4.8
Code: 0037

Model: SP Octa
Implant Ø: 4.8
Platform: 6.5
Code: 0096

Model: Aqua CM
Implant Ø: 3.5/4/5
Platform: 2.82
Code: 0004

RADHEX

Model: PHE
Implant Ø: 3.5
Platform: 3.5
Code: 0023

Model: PHE
Implant Ø: 4/4.5/5
Platform: 4.1
Code: 0024

Model: PHI
Implant Ø: 3.75
Platform: 3.5
Code: 0040

Model: PHI
Implant Ø: 4.5/5
Platform: 4.5
Code: 0041

REFLECT

Model: Rapid
Implant Ø: 3.0
Platform: 3.0
Code: 0159

Model: Rapid
Implant Ø: 3.5
Platform: NP
Code: 0021

Model: Rapid
Implant Ø: 4.3/5/5.5
Platform: RP
Code: 0022

Model: Recover
Implant Ø: 3.5
Platform: NP
Code: 0021

Model: Recover
Implant Ø: 4.3/5
Platform: RP
Code: 0022

Model: Aspire
Implant Ø: 3.5/4
Platform: Aqua(Estrecha)
Code: 0004

Model: Aspire
Implant Ø: 5
Platform: Lilac (Ancha)
Code: 0005

Model: Tapered Screw
Implant Ø: 3.5
Platform: 3.5
Code: 0040

Model: Tapered Screw
Implant Ø: 4.1/4.7
Platform: 4.5
Code: 0041

ROOTT

Model: R
Implant Ø: 3.5/3.8/4.2/4.8/5.5
Platform: Universal
Code: 0236

SEWON MEDIX

Model: IH2 SLA SYSTEM
Implant Ø: 3.5
Platform: Mini
Code: 0029

Model: IH2 SLA SYSTEM
Implant Ø: 3.5/4/4.5/5
Platform: Regular
Code: 0030

Model: IH2 RBM SYSTEM
Implant Ø: 3.5
Platform: Mini
Code: 0029

Model: IH2 RBM SYSTEM
Implant Ø: 3.5/4/4.5/5
Platform: Regular
Code: 0030

Model: IH SYSTEM
Implant Ø: 3.5/4/4.5/5
Platform: Universal
Code: 0025

SIC INVENT

Model: HEXAGONAL SYSTEM
SICace
Implant Ø: 3.4/4
Platform: 3.3
Code: 0170

Model: HEXAGONAL SYSTEM
SICace
Implant Ø: 4.5/5
Platform: 4.2
Code: 0171

Model: HEXAGONAL SYSTEM
SICMax
Implant Ø: 3.4/4.2
Platform: 3.3
Code: 0170

Model: HEXAGONAL SYSTEM
SICMax
Implant Ø: 4.7/5.2
Platform: 4.2
Code: 0171

Model: HEXAGONAL SYSTEM
SICMax
Implant Ø: 3.4/4.2
Platform: 3.3
Code: 0170

Model: HEXAGONAL SYSTEM
SICtapered
Implant Ø: 3.4/4.2
Platform: 3.3
Code: 0170

Model: HEXAGONAL SYSTEM
SICtapered
Implant Ø: 4.7/5.2
Platform: 4.2
Code: 0171

SIGNO VINCES

Model: Duo
Implant Ø: 3.8
Platform: 3.3
Code: 0078

Model: Duo
Implant Ø: 4.6
Platform: 4.1
Code: 0024

Model: Inttegra
Implant Ø: 3.25
Platform: 3.3
Code: 0078

Model: Inttegra
Implant Ø: 3.75/4
Platform: 4.1
Code: 0024

Model: Compact
Implant Ø: 4.5
Platform: CM3.8
Code: 0004

Model: Duocon
Implant Ø: 3.8
Platform: CM3.8
Code: 0004

Model: Duocon
Implant Ø: 4.6/5.5
Platform: CM4.6
Code: 0005

Model: Infra
Implant Ø: 3.3/3.8/4.6
Platform: CM
Code: 0004

SIN IMPLANTS

Model: HI SW
Implant Ø: 3.8
Platform: 3.8
Code: 0039

Model: Tryon
Implant Ø: 3.25/3.75/4
Platform: 4.1
Code: 0024

Model: Tryon CO
Implant Ø: 4
Platform: 4.1
Code: 0024

Model: Revolution
Implant Ø: 3.25/3.75/4
Platform: 4.1
Code: 0024

Model: Stylus
Implant Ø: 4
Platform: 4.1
Code: 0024

SOUTHERN IMPLANTS

Model: Tri-Nex
Implant Ø: 3.5
Platform: 3.5
Code: 0026

Model: Tri-Nex
Implant Ø: 4.3
Platform: 4.3
Code: 0027

Model: Tri-Nex
Implant Ø: 5
Platform: 5
Code: 0028

Model: Tri-Nex
Implant Ø: 6
Platform: 6
Code: 0129

Model: IT Connection
Implant Ø: 3.3/4/4.1/4.9/5
Platform: 4.8
Code: 0037

Model: IT Connection
Implant Ø: 4.9/5/6
Platform: 6.5
Code: 0096

Model: External Hex
Implant Ø: 3.25
Platform: 3.4
Code: 0003

Model: External Hex
Implant Ø: 3.75/4
Platform: 4.1
Code: 0024

Model: External Hex
Implant Ø: 4.7/5
Platform: 5
Code: 0058

Model: External Hex
Implant Ø: 5.7/6
Platform: 6
Code: 0058

Model: Deep Conical
Implant Ø: 3
Platform: 2.45
Code: 0109

Model: Deep Conical
Implant Ø: 3.5/4
Platform: 2.95/3.1
Code: 0004

Model: Deep Conical
Implant Ø: 5
Platform: 4.1
Code: 0005

Model: Internal Hex
Implant Ø: 3.75/4.2/5
Platform: Universal
Code: 0040

COMPATIBILITIES AVAILABLE

Model: Provata
Implant Ø: 4/5/6
Platform: Standard
Code: 0040

Model: Compact Conical
Implant Ø: 4.8
Platform: 4.8
Code: 0025

STERI-OSS

Model: Hex-Loc
Implant Ø: 3.25
Platform: 3.3
Code: 0023

STERNGOLD

Model: STERN EX
Implant Ø: 3.75/4/5
Platform: 4.1
Code: 0024

STRAUMANN

Model: Tissue Level
Implant Ø: 3.3
Platform: 3.5
Code: 0160

Model: Tissue Level
Implant Ø: 3.3/4.1/4.8
Platform: Regular 4.8
Code: 0037

Model: Tissue Level
Implant Ø: 4.8
Platform: Wide 6.5
Code: 0096

Model: Synocta
Implant Ø:
Platform: Regular 4.8
Code: 0074

Model: Synocta
Implant Ø:
Platform: Wide 6.5
Code: 0137

Model: Bone Level Tapered SC
Implant Ø: 2.9
Platform: SC- 2.9
Code: 0135

Model: Bone Level
Implant Ø: 3.3
Platform: NC- 3.3
Code: 0033

Model: Bone Level
Implant Ø: 4.1
Platform: RC-4.1
Code: 0035

Model: Bone Level
Implant Ø: 4.8
Platform: RC-4.8
Code: 0035

Model: Screw-Retained
Implant Ø: NC/RC Ø4.6
Platform: Universal
Code: 0101

Model: BLX
Implant Ø: 3.5/3.75/4/4.5
Platform: RB (Regular Base)
Code: 0207

Model: BLX
Implant Ø: 5/5.5/6.5
Platform: WB (Wide Base)
Code: 0208

Model: TLX / TLX S
Implant Ø: 3.75/4.5
Platform: NT
Code: 0260

Model: TLX / TLX S
Implant Ø: 3.75/4.5
Platform: RT
Code: 0261

Model: TLX / TLX S
Implant Ø: 5.5/6.5
Platform: WT
Code: 0262

SYBRON IMPLANT SOLUTIONS

Model: Endopore (Innova)
Implant Ø: 4.1
Platform: 4.1
Code: 0024

SYSTHEX

Model: Classic-ci / Estetic-ci
Implant Ø: 3.5/3.75/4
Platform: 4.1
Code: 0024

Model: Fit-hex
Implant Ø: 3.3
Platform: 3.3
Code: 0078

Model: Classic Tradicional
Implant Ø: 5
Platform: 5
Code: 0079

TBR

Model: Hex-Conic
Implant Ø: 3.5
Platform: Narrow
Code: 0023

Model: Hex-Conic
Implant Ø: 5
Platform: Wide
Code: 0058

Model: Connect / Infinity
Implant Ø: 3.5
Platform: 3.5
Code: 0266

Model: Connect / Infinity
Implant Ø: 4
Platform: 4
Code: 0267

Model: Connect / Infinity
Implant Ø: 5
Platform: 5
Code: 0268

Model: Baby 8
Implant Ø: 4
Platform: 4
Code: 0267

Model: Baby 8
Implant Ø: 5
Platform: 5
Code: 0268

Model: Z1 Internal Octagon
Implant Ø: 3.5
Platform: 3.5
Code: 0248

Model: Z1 Internal Octagon
Implant Ø: 4
Platform: 4
Code: 0248

Model: Z1 Internal Octagon
Implant Ø: 5
Platform: 5
Code: 0248

TITANIUM-FIX

Model: b-fix
Implant Ø: 3.5/4
Platform: Regular
Code: 0004

Model: b-fix
Implant Ø: 4.5/5
Platform: Larga
Code: 0005

TREE-OSS

Model: Simple
Implant Ø: 3.3/3.75/5
Platform: 3.75 Amarillo
Code: 0040

Model: Rapid/Anatomic
Implant Ø: 3.3
Platform: 3.5 Rosa
Code: 0023

Model: Rapid/Anatomic
Implant Ø: 3.75/4
Platform: 4.1 Amarillo
Code: 0024

Model: Rapid/Anatomic
Implant Ø: 5
Platform: 5.1 Azul
Code: 0061

Model: Anatomic/HS
Implant Ø: 3.5
Platform: 3.5 Rosa
Code: 0026

Model: Anatomic/HS
Implant Ø: 4.3
Platform: 4.3 Amarillo
Code: 0027

Model: Anatomic/HS
Implant Ø: 5
Platform: 5 Azul
Code: 0028

Model: Multi Unit
Implant Ø:
Platform: Universal
Code: 0025

TRI DENTAL IMPLANTS

Model: TRI-Vent
Implant Ø: 3.75/4.1/4.7
Platform: 3.5
Code: 0040

Model: TRI-Vent
Implant Ø: 3.75/4.1/4.7
Platform: 3.5
Code: 0042

TRINON

Model: Q2
Implant Ø: 3.5/3.75/4.5
Platform: 4
Code: 0024

Model: QK
Implant Ø: 4
Platform: 4.8
Code: 0074

Model: QK
Implant Ø: 4
Platform: 4.8
Code: 0037

UFIT

Model: Gt2
Implant Ø: 3.5
Platform: Mini
Code: 0004

Model: Gt2
Implant Ø: 4/4.5
Platform: Regular
Code: 0005

Model: Gt2
Implant Ø: 5
Platform: Wide
Code: 0005

Model: Gt2
Implant Ø: 5.5/6/6.5/7
Platform: Ultra-wide
Code: 0005

Model: Nt2
Implant Ø: 3.5
Platform: Mini
Code: 0004

Model: Nt2
Implant Ø: 4/4.5
Platform: Regular
Code: 0005

Model: Nt2
Implant Ø: 5
Platform: Wide
Code: 0005

Model: Nt2
Implant Ø: 5.5/6/6.5/7
Platform: Ultra-wide
Code: 0005

VULKAN IMPLANTS

Model: IN-Hex
Implant Ø: 3.3/3.75/4.2/5
Platform: 3.75
Code: 0040

WIN

Model: WIN
Implant Ø: 3.30/3.75/4.25/5
Platform: 3.75
Code: 0040

Model: WIN
Implant Ø: Universal
Platform: Universal
Code: 0025

XIVE

Model: Xive
Implant Ø: 3
Platform: 3
Code: 0084

Model: Xive
Implant Ø: 3.4
Platform: 3.4
Code: 0038

Model: Xive
Implant Ø: 3.8
Platform: 3.8
Code: 0039

Model: Xive
Implant Ø: 4.5
Platform: 4.5
Code: 0085

Model: Xive
Implant Ø: 5.5
Platform: 5.5
Code: 0086

YES IMPLANT

Model: S-SYSTEM
Implant Ø: 3.3/3.5
Platform: Narrow
Code: 0030

Model: S-SYSTEM
Implant Ø: 4/4.5
Platform: Regular
Code: 0030

Model: S-SYSTEM
Implant Ø: 5/5.5
Platform: Wide
Code: 0030

ZIACOM

Model: OEX
Implant Ø: 3.75/4.25
Platform: RP 4.1
Code: 0024

Model: ZINIC
Implant Ø: 3.7/4.1/4.3
Platform: RP 3.5
Code: 0040

Model: ZINIC Shorty
Implant Ø: 4.75
Platform: RP 3.5
Code: 0040

ZIMMER

Model: Screw-Vent
Implant Ø: 3.7/4.1
Platform: 3.5
Code: 0040

Model: Screw-Vent
Implant Ø: 3.7/4.1
Platform: 3.5
Code: 0042

Model: Screw-Vent
Implant Ø: 4.7
Platform: 4.5
Code: 0041

Model: Screw-Vent
Implant Ø: 4.7
Platform: 4.5
Code: 0043

Model: Screw-Vent
Implant Ø: 6
Platform: 5.7
Code: 0080

Model: TSX Implant
Implant Ø: 3.1
Platform: 2.9
Code: 0178

Model: TSX Implant
Implant Ø: 3.7/4.1/4.7
Platform: 3.5
Code: 0040

Model: TSX Implant
Implant Ø: 3.7/4.1/4.7
Platform: 3.5
Code: 0042

Model: TSX Implant
Implant Ø: 5.4/6
Platform: 4.5
Code: 0041

Model: TSX Implant
Implant Ø: 5.4/6
Platform: 4.5
Code: 0043

Model: Swiss-Plus
Implant Ø: 3.7/4.1/4.8
Platform: 4.8
Code: 0074

Model: Swiss-Plus
Implant Ø: 3.7/4.1/4.8
Platform: 4.8
Code: 0037

Model: Eztetic
Implant Ø: 3.1
Platform: 2.9
Code: 0178

Model: Tapered Abutment
Implant Ø: Universal
Platform: Universal
Code: 0205

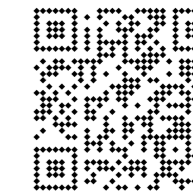

This printed version is probably outdated and may not include all products or compatibilities.

Access and download the latest version of this catalogue

www.dynamicaabutment.com

Some of the compatibilities listed may not appear in the catalogue, as some of the associated products are being developed and/or manufactured. If you have any queries, please contact us.

STANDARD DYNAMIC TIBASE															
	GINGIVAL HEIGHT	α_s	α_c	GINGIVAL HEIGHT	α_s	α_c	GINGIVAL HEIGHT	α_s	α_c	GINGIVAL HEIGHT	α_s	α_c	GINGIVAL HEIGHT	α_s	α_c
	0.3 mm			1.2 mm			2 mm			3 mm			mm		
R	31.322.001.01-2	43°	25°	31.322.001.02-2	25°	-	31.322.001.03-2	25°	-	31.322.001.04-2	20°	-	-	-	-
NR	31.312.001.01-2			31.312.001.02-2			31.312.001.03-2			31.312.001.04-2			-	-	-

DYNAMIC 3TIBASE

	GINGIVAL HEIGHT	α_s	α_c	α_s	α_c
	0.3 mm	CH-5mm	CH- 7mm	CH- 9mm	
R	31.322.001.21-2	25°	20°	10°	
NR	31.312.001.21-2				

DYNAMIC SCANBODY (LAB/CLIN)

SCANBODY	HEIGHT mm	ADAPTOR	SCREWDRIVER ADAPTOR	DIGITAL ANALOG
52.410.103.01-2	10	50.312.001.01-2	43.621.410.01-2	34.612.001.01-2
52.412.103.01-2	12	50.312.001.04-2 (IG-3mm)	43.624.410.01-2	

DIGITAL ANALOG

DYNAMIC MILLING TOOL

DYNAMIC MILLING TOOL	SHANK	α_{di}
33.390.754.01-2	3	25°
33.490.754.01-2	4	
33.690.754.01-2	6	

SCANALOG

23.412.001.01-2

DYNAMIC SCREWS

DYNAMIC SCREW	HIGH DYNAMIC SCREW	DYNAMIC SCREWDRIVER	SCREWDRIVER LENGTH (mm)
41.316.084.01-2	-	43.618.201.01-2	18
		43.624.201.01-2	24
		43.632.201.01-2	32

STRAIGHT SCREWS

STRAIGHT SCREW	SCREWDRIVER Hex. 1.20
40.316.003.01-2	43.601.103.02-2

ANALOG	LAB SCANBODY
22.612.001.01-2	30.412.001.01-2

MULTI-UNIT

	GINGIVAL HEIGHT	GINGIVAL HEIGHT	GINGIVAL HEIGHT	GINGIVAL HEIGHT
	1 mm	2 mm	3 mm	4 mm
R	42.302.001.01-2	42.302.001.02-2	42.302.001.03-2	42.302.001.04-2

LIBRARY OPTIONS
GH = Gingival Height α_s - Standard maximum angulation
CH = Cement Height α_c - Captive maximum angulation
IG = Adaptor 3mm α_{di} - Direct to implant maximum angulation
R = Rotational / Non-Engaging
NR = Non Rotational / Engaging

STANDARD DYNAMIC TIBASE															
	GINGIVAL HEIGHT	α_s	α_c	GINGIVAL HEIGHT	α_s	α_c	GINGIVAL HEIGHT	α_s	α_c	GINGIVAL HEIGHT	α_s	α_c	GINGIVAL HEIGHT	α_s	α_c
	0.3 mm			1.2 mm			mm			mm			mm		
R	31.323.002.01-2	45°	20°	31.323.002.02-2	25°	-	-	-	-	-	-	-	-	-	-
NR	31.313.002.01-2			31.313.002.02-2			-	-	-	-	-				

DYNAMIC 3TIBASE

	GINGIVAL HEIGHT	α_s	α_c	α_s	α_c
	0.3 mm	CH-5mm	CH- 7mm	CH- 9mm	
R	31.323.002.21-2	25°	20°	10°	
NR	31.313.002.21-2				

DYNAMIC SCANBODY (LAB/CLIN)

SCANBODY	HEIGHT mm	ADAPTOR	SCREWDRIVER ADAPTOR	DIGITAL ANALOG
52.408.101.01-2	8	50.313.002.01-2	43.621.410.01-2	34.613.002.01-2
52.410.101.01-2	10			
52.412.101.01-2	12			

DIGITAL ANALOG

DYNAMIC MILLING TOOL

DYNAMIC MILLING TOOL	SHANK	α_{di}
33.390.805.01-2	3	30°
33.490.805.01-2	4	
33.690.805.01-2	6	

SCANALOG

23.413.002.01-2

DYNAMIC SCREWS

DYNAMIC SCREW	HIGH DYNAMIC SCREW	DYNAMIC SCREWDRIVER	SCREWDRIVER LENGTH (mm)
41.316.084.01-2	-	43.618.201.01-2	18
		43.624.201.01-2	24
		43.632.201.01-2	32

STRAIGHT SCREWS

STRAIGHT SCREW	SCREWDRIVER Hex. 1.20
40.316.003.01-2	43.601.103.02-2

ANALOG	LAB SCANBODY
22.613.002.01-2	30.413.002.01-2

MULTI-UNIT

	GINGIVAL HEIGHT	GINGIVAL HEIGHT	GINGIVAL HEIGHT
	2 mm	3 mm	4 mm
R	42.303.002.02-2	42.303.002.03-2	42.303.002.04-2

LIBRARY OPTIONS
GH = Gingival Height α_s - Standard maximum angulation
CH = Cement Height α_c - Captive maximum angulation
IG = Adaptor 3mm α_{di} - Direct to implant maximum angulation
R = Rotational / Non-Engaging
NR = Non Rotational / Engaging

STANDARD DYNAMIC TIBASE															
	GINGIVAL HEIGHT	α_s	α_c	GINGIVAL HEIGHT	α_s	α_c	GINGIVAL HEIGHT	α_s	α_c	GINGIVAL HEIGHT	α_s	α_c	GINGIVAL HEIGHT	α_s	α_c
	0.3 mm			0.5 mm			mm			mm			mm		
R	31.322.003.01-2	45°	30°	31.322.003.02-2	25°	-	-	-	-	-	-	-	-	-	-
NR	31.312.003.01-2			31.312.003.02-2			-	-	-	-	-	-	-	-	-

DYNAMIC 3TIBASE				
	GINGIVAL HEIGHT	α_s	α_c	α_s
	1 mm	CH+5mm	CH+ 7mm	CH+ 9mm
R	31.322.003.23-2	30°	25°	15°
NR	31.312.003.23-2			

DYNAMIC SCANBODY (LAB/CLIN)				DIGITAL ANALOG
SCANBODY	HEIGHT mm	ADAPTOR	SCREWDRIVER ADAPTOR	DIGITAL ANALOG
52.410.104.01-2	10	50.312.003.01-2	43.621.410.01-2	34.612.003.01-2
			43.624.410.01-2	
52.412.104.01-2	12			

DYNAMIC MILLING TOOL		
DYNAMIC MILLING TOOL	SHANK	α_{di}
33.390.716.01-2	3	25°
33.490.716.01-2	4	
33.690.716.01-2	6	

DYNAMIC SCREWS			
DYNAMIC SCREW	HIGH DYNAMIC SCREW	DYNAMIC SCREWDRIVER	SCREWDRIVER LENGTH (mm)
41.320.065.01-2	-	43.618.201.01-2	18
		43.624.201.01-2	24
		43.632.201.01-2	32

STRAIGHT SCREWS		ANALOG	LAB SCANBODY
STRAIGHT SCREW	SCREWDRIVER Hex. 1.20		
40.320.003.02-2	43.601.103.02-2	22.612.003.01-2	30.412.001.01-2

LIBRARY OPTIONS
GH = Gingival Height α_s - Standard maximum angulation
CH = Cement Height α_c - Captive maximum angulation
IG = Adaptor 3mm α_s - Direct to implant maximum angulation
R = Rotational / Non-Engaging
NR = Non Rotational / Engaging

STANDARD DYNAMIC TIBASE															
	GINGIVAL HEIGHT	α_s	α_c	GINGIVAL HEIGHT	α_s	α_c	GINGIVAL HEIGHT	α_s	α_c	GINGIVAL HEIGHT	α_s	α_c	GINGIVAL HEIGHT	α_s	α_c
	1 mm			2 mm			3 mm			4 mm			mm		
R	31.323.004.01-2	45°	29°	31.323.004.02-2	30°	20°	31.323.004.03-2	25	-	31.323.004.04-2	20	-	-	-	-
NR	31.313.004.01-2			31.313.004.02-2			31.313.004.03-2			31.313.004.04-2			-	-	-

DYNAMIC 3TIBASE				
	GINGIVAL HEIGHT	α_s	α_c	α_s
	1 mm	CH+5mm	CH+ 7mm	CH+ 9mm
R	31.323.004.21-2	25°	20°	10°
NR	31.313.004.21-2			

DYNAMIC SCANBODY (LAB/CLIN)				DIGITAL ANALOG
SCANBODY	HEIGHT mm	ADAPTOR	SCREWDRIVER ADAPTOR	DIGITAL ANALOG
52.410.103.01-2	10	50.313.004.01-2	43.621.410.01-2	34.613.004.01-2
		50.313.004.03-2 (IG=3mm)	43.624.410.01-2	34.613.004.02-2
52.412.103.01-2	12			

DYNAMIC MILLING TOOL			SCANALOG	SCANBODY OP		
DYNAMIC MILLING TOOL	SHANK	α_{di}		SCANBODY	PEEK PINS mm	
33.390.754.01-2	3	25°	23.413.004.02-2	54.315.004.21-2	49.414.000.01-2	6
33.490.754.01-2	4				49.415.000.01-2	9
33.690.754.01-2	6				49.416.000.01-2	13

SCREWDRIVER 43.625.105.01-2

DYNAMIC SCREWS			
DYNAMIC SCREW	HIGH DYNAMIC SCREW	DYNAMIC SCREWDRIVER	SCREWDRIVER LENGTH (mm)
41.316.076.01-2	-	43.618.201.01-2	18
		43.624.201.01-2	24
		43.632.201.01-2	32

STRAIGHT SCREWS		ANALOG	LAB SCANBODY
SCREWDRIVER Hex. 1.27			
43.601.105.01-2		22.613.004.01-2	30.413.002.01-2

MULTI-UNIT				
	GINGIVAL HEIGHT	GINGIVAL HEIGHT	GINGIVAL HEIGHT	GINGIVAL HEIGHT
	1 mm	2 mm	3 mm	4 mm
R	42.303.004.01-2	42.303.004.02-2	42.303.004.03-2	42.303.004.04-2

LIBRARY OPTIONS
GH = Gingival Height α_s - Standard maximum angulation
CH = Cement Height α_c - Captive maximum angulation
IG = Adaptor 3mm α_s - Direct to implant maximum angulation
R = Rotational / Non-Engaging
NR = Non Rotational / Engaging

STANDARD DYNAMIC TIBASE															
	GINGIVAL HEIGHT	α_s	α_c	GINGIVAL HEIGHT	α_s	α_c	GINGIVAL HEIGHT	α_s	α_c	GINGIVAL HEIGHT	α_s	α_c	GINGIVAL HEIGHT	α_s	α_c
	1 mm			2 mm			3 mm			4 mm			mm		
R	31.324.005.01-2	38°	23°	31.324.005.02-2	25°	15°	31.324.005.03-2	20	-	31.324.005.04-2	15	-	-	-	-
NR	31.314.005.01-2			31.314.005.02-2			31.314.005.03-2			31.314.005.04-2			-	-	-

DYNAMIC 3TIBASE				
	GINGIVAL HEIGHT	α_s	α_c	α_s
	1 mm	CH-5mm	CH- 7mm	CH- 9mm
R	31.324.005.21-2	25°	20°	10°
NR	31.314.005.21-2			

DYNAMIC SCANBODY (LAB/CLIN)				DIGITAL ANALOG
SCANBODY	HEIGHT mm	ADAPTOR	SCREWDRIVER ADAPTOR	DIGITAL ANALOG
52.410.102.01-2	10	50.314.005.01-2	43.621.410.01-2 43.624.410.01-2	34.614.005.01-2
52.412.102.01-2	12	50.314.005.03-2 (IG-3mm)		

DYNAMIC MILLING TOOL		
DYNAMIC MILLING TOOL	SHANK	α_{di}
33.390.958.01-2	3	30°
33.490.958.01-2	4	
33.690.958.01-2	6	

DYNAMIC SCREWS			
DYNAMIC SCREW	HIGH DYNAMIC SCREW	DYNAMIC SCREWDRIVER	SCREWDRIVER LENGTH (mm)
41.320.090.01-2	-	43.618.201.01-2	18
		43.624.201.01-2	24
		43.632.201.01-2	32

STRAIGHT SCREWS	
STRAIGHT SCREW	SCREWDRIVER Hex. 1.27
40.320.005.03-2	43.601.105.01-2

ANALOG	LAB SCANBODY
22.614.005.01-2	30.413.002.01-2

LIBRARY OPTIONS

GH = Gingival Height α_s - Standard maximum angulation
CH = Cement Height α_c - Captive maximum angulation
IG = Adaptor 3mm α_{di} - Direct to implant maximum angulation
R = Rotational / Non-Engaging
NR = Non Rotational / Engaging

STANDARD DYNAMIC TIBASE															
	GINGIVAL HEIGHT	α_s	α_c	GINGIVAL HEIGHT	α_s	α_c	GINGIVAL HEIGHT	α_s	α_c	GINGIVAL HEIGHT	α_s	α_c	GINGIVAL HEIGHT	α_s	α_c
	1.2 mm			2 mm			3 mm			4 mm			mm		
R	31.322.006.01-2	40°	20°	31.322.006.02-2	25	-	31.322.006.03-2	20	-	31.322.006.04-2	15	-	-	-	-
NR	31.312.006.01-2			31.312.006.02-2			31.312.006.03-2			31.312.006.04-2			-	-	-

DYNAMIC 3TIBASE				
	GINGIVAL HEIGHT	α_s	α_c	α_s
		CH-5mm	CH- 7mm	CH- 9mm
R	31.322.006.21-2	30°	20°	15°
NR	31.312.006.21-2			

DYNAMIC SCANBODY (LAB/CLIN)				DIGITAL ANALOG
SCANBODY	HEIGHT mm	ADAPTOR	SCREWDRIVER ADAPTOR	DIGITAL ANALOG
52.410.105.01-2	10	50.312.006.03-2 (IG-3mm)	43.621.410.01-2 43.624.410.01-2	34.612.006.01-2
52.412.105.01-2	12			

DYNAMIC MILLING TOOL		
DYNAMIC MILLING TOOL	SHANK	α_{di}
33.330.734.01-2	3	25°
33.430.734.01-2	4	
33.630.734.01-2	6	

SCANALOG
23.412.006.01-2

SCANBODY OP		
SCANBODY	PEEK PINS	mm
54.315.006.21-2	49.414.000.01-2	6
	49.415.000.01-2	9
	49.416.000.01-2	13

SCREWDRIVER 43.625.105.01-2

DYNAMIC SCREWS			
DYNAMIC SCREW	HIGH DYNAMIC SCREW	DYNAMIC SCREWDRIVER	SCREWDRIVER LENGTH (mm)
41.316.072.01-2	41.316.115.01-2	43.618.201.01-2	18
		43.624.201.01-2	24
		43.632.201.01-2	32

STRAIGHT SCREWS	
STRAIGHT SCREW	SCREWDRIVER Hex. 1.27
40.316.005.01-2	43.625.105.01-2

ANALOG	LAB SCANBODY
22.612.006.01-2	30.412.001.01-2

MULTI-UNIT				
	GINGIVAL HEIGHT	GINGIVAL HEIGHT	GINGIVAL HEIGHT	GINGIVAL HEIGHT
	1 mm	2 mm	3 mm	4 mm
R	42.302.006.01-2	42.302.006.02-2	42.302.006.03-2	42.302.006.04-2

LIBRARY OPTIONS

GH = Gingival Height α_s - Standard maximum angulation
CH = Cement Height α_c - Captive maximum angulation
IG = Adaptor 3mm α_{di} - Direct to implant maximum angulation
R = Rotational / Non-Engaging
NR = Non Rotational / Engaging

STANDARD DYNAMIC TIBASE															
	GINGIVAL HEIGHT	α_s	α_c	GINGIVAL HEIGHT	α_s	α_c	GINGIVAL HEIGHT	α_s	α_c	GINGIVAL HEIGHT	α_s	α_c	GINGIVAL HEIGHT	α_s	α_c
	1.5 mm			2 mm			3 mm			mm			mm		
R	31.323.007.01-2	38°	17°	31.323.007.02-2	25°	-	-	-	-	-	-	-	-	-	-
NR	31.313.007.01-2			31.313.007.02-2			31.313.007.03-2			-			-		

DYNAMIC 3TIBASE				
	GINGIVAL HEIGHT	α_s	α_c	α_s
	1.5 mm	CH=5mm	CH= 7mm	CH= 9mm
R	31.323.007.21-2	25°	20°	10°
NR	31.313.007.21-2			

DYNAMIC SCANBODY (LAB/CLIN)					DIGITAL ANALOG	DYNAMIC MILLING TOOL			SCANALOG	SCANBODY OP				
SCANBODY	HEIGHT mm	ADAPTOR	SCREWDRIVER ADAPTOR	DIGITAL ANALOG	DYNAMIC MILLING TOOL	SHANK	α_{di}	SCANBODY	PEEK PINS	mm	SCANBODY	PEEK PINS	mm	
52.408.101.01-2	8	50.313.007.01-2 50.313.007.03-2 (IG=3mm)	43.621.410.01-2 43.624.410.01-2	34.613.007.01-2	33.350.775.01-2	3	25°	23.413.007.01-2	54.315.007.21-2	49.414.000.01-2	6	54.315.007.21-2	49.415.000.01-2	9
52.410.101.01-2	10				33.450.775.01-2	4				49.416.000.01-2	13			
52.412.101.01-2	12				33.650.775.01-2	6								

SCREWDRIVER 43.625.105.01-2

DYNAMIC SCREWS				STRAIGHT SCREWS		LAB SCANBODY
DYNAMIC SCREW	HIGH DYNAMIC SCREW	DYNAMIC SCREWDRIVER	SCREWDRIVER LENGTH (mm)	STRAIGHT SCREW	SCREWDRIVER Hex. 1.27	LAB SCANBODY
41.318.074.01-2	-	43.618.201.01-2	18	40.318.005.02-2	43.601.105.01-2	30.413.002.01-2
		43.624.201.01-2	24			
		43.632.201.01-2	32			

MULTI-UNIT				
	GINGIVAL HEIGHT	GINGIVAL HEIGHT	GINGIVAL HEIGHT	GINGIVAL HEIGHT
	1 mm	2 mm	3 mm	4 mm
R	42.303.007.01-2	42.303.007.02-2	42.303.007.03-2	42.303.007.04-2

LIBRARY OPTIONS

GH = Gingival Height α_s - Standard maximum angulation
CH = Cement Height α_c - Captive maximum angulation
IG = Adaptor 3mm α_{di} - Direct to implant maximum angulation
R = Rotational / Non-Engaging
NR = Non Rotational / Engaging

STANDARD DYNAMIC TIBASE															
	GINGIVAL HEIGHT	α_s	α_c	GINGIVAL HEIGHT	α_s	α_c	GINGIVAL HEIGHT	α_s	α_c	GINGIVAL HEIGHT	α_s	α_c	GINGIVAL HEIGHT	α_s	α_c
	0.5 mm			mm			mm			mm			mm		
R	31.323.008.01-2	45°	30°	-	-	-	-	-	-	-	-	-	-	-	-
NR	-			-			-			-			-		

DYNAMIC 3TIBASE				
	GINGIVAL HEIGHT	α_s	α_c	α_s
	0.5 mm	CH=5mm	CH= 7mm	CH= 9mm
R	31.323.008.21-2	25°	20°	10°
NR	-			

DYNAMIC SCANBODY (LAB/CLIN)					DIGITAL ANALOG	DYNAMIC MILLING TOOL			SCANALOG	REFERENCE SCANBODY				
SCANBODY	HEIGHT mm	ADAPTOR	SCREWDRIVER ADAPTOR	DIGITAL ANALOG	DYNAMIC MILLING TOOL	SHANK	α_{di}	SCANBODY	PEEK PINS	mm	SCANBODY	PEEK PINS	mm	
52.408.113.01-2	8	50.313.008.01-2	43.621.410.01-2 43.624.410.01-2	34.613.008.01-2	33.370.716.01-2	3	30°	23.413.008.01-2	54.322.008.31-2	49.414.000.01-2	6	54.322.008.31-2	49.415.000.01-2	9
					33.470.716.01-2	4				49.416.000.01-2	13			
					33.670.716.01-2	6				CAPS	mm			
													49.418.000.01-2	3.8
													49.419.000.01-2	6
													49.420.000.01-2	8

SCREWDRIVER: 43.625.105.01-2

DYNAMIC SCREWS				STRAIGHT SCREWS		ANALOG	LAB SCANBODY
DYNAMIC SCREW	HIGH DYNAMIC SCREW	DYNAMIC SCREWDRIVER	SCREWDRIVER LENGTH (mm)	STRAIGHT SCREW	SCREWDRIVER Hex. 1.27	ANALOG	LAB SCANBODY
41.318.045.01-2	-	43.618.201.01-2	18	40.318.005.01-2	43.601.105.01-2	-	30.412.001.01-2
		43.624.201.01-2	24				
		43.632.201.01-2	32				

LIBRARY OPTIONS

GH = Gingival Height α_s - Standard maximum angulation
CH = Cement Height α_c - Captive maximum angulation
IG = Adaptor 3mm α_{di} - Direct to implant maximum angulation
R = Rotational / Non-Engaging
NR = Non Rotational / Engaging

STANDARD DYNAMIC TIBASE															
	GINGIVAL HEIGHT	α_s	α_c	GINGIVAL HEIGHT	α_s	α_c	GINGIVAL HEIGHT	α_s	α_c	GINGIVAL HEIGHT	α_s	α_c	GINGIVAL HEIGHT	α_s	α_c
	0.3 mm			0.5 mm			1 mm			mm			mm		
R	31.322.009.01-2	45°	25°	31.322.009.02-2	25°	25°	31.322.009.03-2	25°	-	-	-	-	-	-	-
NR	31.312.009.01-2			31.312.009.02-2			31.312.009.03-2		-	-	-	-	-		

DYNAMIC 3TIBASE				
	GINGIVAL HEIGHT	α_s	α_c	α_s
		CH+5mm	CH+ 7mm	CH+ 9mm
R	-	-	-	-
NR	-	-	-	-

DYNAMIC SCANBODY (LAB/CLIN)				DIGITAL ANALOG
SCANBODY	HEIGHT mm	ADAPTOR	SCREWDRIVER ADAPTOR	DIGITAL ANALOG
52.410.114.01-2	10	50.312.009.01-2	43.621.410.01-2 43.624.410.01-2	34.612.009.01-2
52.412.114.01-2	12			

DYNAMIC MILLING TOOL		
DYNAMIC MILLING TOOL	SHANK	α_{di}
33.390.716.01-2	3	25°
33.490.716.01-2	4	
33.690.716.01-2	6	

DYNAMIC SCREWS			
DYNAMIC SCREW	HIGH DYNAMIC SCREW	DYNAMIC SCREWDRIVER	SCREWDRIVER LENGTH (mm)
41.320.051.01-2	-	43.618.201.01-2	18
		43.624.201.01-2	24
		43.632.201.01-2	32

STRAIGHT SCREWS	
STRAIGHT SCREW	SCREWDRIVER Hex. 1.20
40.320.003.01-2	43.601.103.02-2

ANALOG	LAB SCANBODY
-	30.412.001.01-2

LIBRARY OPTIONS

GH = Gingival Height α_s - Standard maximum angulation
CH = Cement Height α_c - Captive maximum angulation
IG = Adaptor 3mm α_s - Direct to implant maximum angulation
R = Rotational / Non-Engaging
NR = Non Rotational / Engaging

STANDARD DYNAMIC TIBASE															
	GINGIVAL HEIGHT	α_s	α_c	GINGIVAL HEIGHT	α_s	α_c	GINGIVAL HEIGHT	α_s	α_c	GINGIVAL HEIGHT	α_s	α_c	GINGIVAL HEIGHT	α_s	α_c
	0.3 mm			mm			mm			mm			mm		
R	31.323.010.01-2	45°	29°	-	-	-	-	-	-	-	-	-	-	-	-
NR	31.313.010.01-2			-	-	-	-	-	-	-	-	-	-	-	-

DYNAMIC 3TIBASE				
	GINGIVAL HEIGHT	α_s	α_c	α_s
		CH+5mm	CH+ 7mm	CH+ 9mm
R	-	-	-	-
NR	-	-	-	-

DYNAMIC SCANBODY (LAB/CLIN)				DIGITAL ANALOG
SCANBODY	HEIGHT mm	ADAPTOR	SCREWDRIVER ADAPTOR	DIGITAL ANALOG
52.410.115.01-2	10	50.313.010.01-2	43.621.410.01-2 43.624.410.01-2	34.613.010.01-2
52.412.115.01-2	12			

DYNAMIC MILLING TOOL		
DYNAMIC MILLING TOOL	SHANK	α_{di}
33.390.716.01-2	3	30°
33.490.716.01-2	4	
33.690.716.01-2	6	

DYNAMIC SCREWS			
DYNAMIC SCREW	HIGH DYNAMIC SCREW	DYNAMIC SCREWDRIVER	SCREWDRIVER LENGTH (mm)
41.318.065.01-2	-	43.618.201.01-2	18
		43.624.201.01-2	24
		43.632.201.01-2	32

STRAIGHT SCREWS	
STRAIGHT SCREW	SCREWDRIVER Hex. 1.20
40.318.003.01-2	43.601.103.02-2

ANALOG	LAB SCANBODY
22.613.010.01-2	30.413.002.01-2

MULTI-UNIT		
	GINGIVAL HEIGHT	GINGIVAL HEIGHT
	3 mm	4 mm
R	42.303.010.03-2	42.303.010.04-2

LIBRARY OPTIONS

GH = Gingival Height α_s - Standard maximum angulation
CH = Cement Height α_c - Captive maximum angulation
IG = Adaptor 3mm α_s - Direct to implant maximum angulation
R = Rotational / Non-Engaging
NR = Non Rotational / Engaging

STANDARD DYNAMIC TIBASE															
	GINGIVAL HEIGHT	α_s	α_c	GINGIVAL HEIGHT	α_s	α_c	GINGIVAL HEIGHT	α_s	α_c	GINGIVAL HEIGHT	α_s	α_c	GINGIVAL HEIGHT	α_s	α_c
	0.3 mm			mm			mm			mm			mm		
R	31.322.011.01-2	25°	29°	-	-	-	-	-	-	-	-	-	-	-	-
NR	31.312.011.01-2			-	-	-	-	-	-	-	-	-	-	-	-

DYNAMIC 3TIBASE								
	GINGIVAL HEIGHT	α_s	α_s	α_s	GINGIVAL HEIGHT	α_s	α_s	α_s
	2mm	CH-5mm	CH- 7mm	CH- 9mm	3mm	CH-5mm	CH- 7mm	CH- 9mm
R		25°	20°	15°	-	25°	20°	10°
NR	31.312.011.23-2				31.312.011.24-2			

DYNAMIC SCANBODY (LAB/CLIN)				DIGITAL ANALOG	DYNAMIC MILLING TOOL		
SCANBODY	HEIGHT mm	ADAPTOR	SCREWDRIVER ADAPTOR	DIGITAL ANALOG	DYNAMIC MILLING TOOL	SHANK	α_{di}
52.410.108.01-2	10	50.312.011.01-2	43.621.410.01-2 43.624.410.01-2	34.612.011.01-2	33.345.804.01-2	3	20°
					33.445.804.01-2	4	
52.412.108.01-2	12				33.645.804.01-2	6	

DYNAMIC SCREWS				STRAIGHT SCREWS		ANALOG		LAB SCANBODY	
DYNAMIC SCREW	HIGH DYNAMIC SCREW	DYNAMIC SCREWDRIVER	SCREWDRIVER LENGTH (mm)	STRAIGHT SCREW	SCREWDRIVER Hex. 1.27				
41.316.094.01-2	-	43.618.201.01-2	18	40.316.005.04-2	43.601.105.01-2	-	-	-	30.412.001.01-2
		43.624.201.01-2	24						
		43.632.201.01-2	32						

LIBRARY OPTIONS

GH = Gingival Height α_s - Standard maximum angulation
CH = Cement Height α_c - Captive maximum angulation
IG = Adaptor 3mm α_d - Direct to implant maximum angulation
R = Rotational / Non-Engaging
NR = Non Rotational / Engaging

STANDARD DYNAMIC TIBASE															
	GINGIVAL HEIGHT	α_s	α_c	GINGIVAL HEIGHT	α_s	α_c	GINGIVAL HEIGHT	α_s	α_c	GINGIVAL HEIGHT	α_s	α_c	GINGIVAL HEIGHT	α_s	α_c
	0.3 mm			mm			mm			mm			mm		
R	31.323.012.01-2	25°	30°	-	-	-	-	-	-	-	-	-	-	-	-
NR	31.313.012.01-2			-	-	-	-	-	-	-	-	-	-	-	-

DYNAMIC 3TIBASE												
	GINGIVAL HEIGHT	α_s	α_s	α_s	GINGIVAL HEIGHT	α_s	α_s	α_s	GINGIVAL HEIGHT	α_s	α_s	α_s
	0.3 mm	CH-5mm	CH- 7mm	CH- 9mm	2 mm	CH-5mm	CH- 7mm	CH- 9mm	3mm	CH-5mm	CH- 7mm	CH- 9mm
R	-	25°	25°	15°	-	25°	20°	15°	-	25°	20°	10°
NR	31.313.012.21-2				31.313.012.23-2				31.313.012.24-2			

DYNAMIC SCANBODY (LAB/CLIN)				DIGITAL ANALOG	DYNAMIC MILLING TOOL		
SCANBODY	HEIGHT mm	ADAPTOR	SCREWDRIVER ADAPTOR	DIGITAL ANALOG	DYNAMIC MILLING TOOL	SHANK	α_{di}
52.410.109.01-2	10	50.313.012.01-2	43.621.410.01-2 43.624.410.01-2	34.613.012.01-2	33.345.804.01-2	3	20°
					33.445.804.01-2	4	
52.412.109.01-2	12				33.645.804.01-2	6	

DYNAMIC SCREWS				STRAIGHT SCREWS		ANALOG		LAB SCANBODY	
DYNAMIC SCREW	HIGH DYNAMIC SCREW	DYNAMIC SCREWDRIVER	SCREWDRIVER LENGTH (mm)	STRAIGHT SCREW	SCREWDRIVER Hex. 1.27				
41.316.094.01-2	-	43.618.201.01-2	18	40.316.005.04-2	43.601.105.01-2	-	-	-	30.413.002.01-2
		43.624.201.01-2	24						
		43.632.201.01-2	32						

LIBRARY OPTIONS

GH = Gingival Height α_s - Standard maximum angulation
CH = Cement Height α_c - Captive maximum angulation
IG = Adaptor 3mm α_d - Direct to implant maximum angulation
R = Rotational / Non-Engaging
NR = Non Rotational / Engaging

STANDARD DYNAMIC TIBASE															
	GINGIVAL HEIGHT	α_s	α_c	GINGIVAL HEIGHT	α_s	α_c	GINGIVAL HEIGHT	α_s	α_c	GINGIVAL HEIGHT	α_s	α_c	GINGIVAL HEIGHT	α_s	α_c
	0.7 mm			mm			mm			mm			mm		
R	31.323.013.01-2	43°	23°	-	-	-	-	-	-	-	-	-	-	-	-
NR	31.313.013.01-2			-	-	-	-	-	-	-	-	-	-	-	-

DYNAMIC 3TIBASE

	GINGIVAL HEIGHT	α_s	α_c	α_s
		CH-5mm	CH-7mm	CH-9mm
R	-	-	-	-
NR	-	-	-	-

DYNAMIC SCANBODY (LAB/CLIN) DIGITAL ANALOG

SCANBODY	HEIGHT mm	ADAPTOR	SCREWDRIVER ADAPTOR	DIGITAL ANALOG
-	-	-	-	-
-	-	-	-	-

DYNAMIC MILLING TOOL

DYNAMIC MILLING TOOL	SHANK	α_{di}
-	-	-
-	-	-

DYNAMIC SCREWS

DYNAMIC SCREW	HIGH DYNAMIC SCREW	DYNAMIC SCREWDRIVER	SCREWDRIVER LENGTH (mm)
41.320.074.01-2	-	43.618.201.01-2	18
		43.624.201.01-2	24
		43.632.201.01-2	32

STRAIGHT SCREWS

STRAIGHT SCREW	SCREWDRIVER TORX T6
40.320.007.02-2	43.601.107.01-2

ANALOG	LAB SCANBODY
-	30.413.002.01-2

LIBRARY OPTIONS
GH = Gingival Height α_s - Standard maximum angulation
CH = Cement Height α_c - Captive maximum angulation
IG = Adaptor 3mm α_s - Direct to implant maximum angulation
R = Rotational / Non-Engaging
NR = Non Rotational / Engaging

STANDARD DYNAMIC TIBASE															
	GINGIVAL HEIGHT	α_s	α_c	GINGIVAL HEIGHT	α_s	α_c	GINGIVAL HEIGHT	α_s	α_c	GINGIVAL HEIGHT	α_s	α_c	GINGIVAL HEIGHT	α_s	α_c
	1.2 mm			2 mm			3 mm			mm			mm		
R	31.322.014.01-2	41°	23°	31.322.014.02-2	25°	17°	-	20°	25°	-	-	-	-	-	-
NR	31.312.014.01-2			31.312.014.02-2	31.312.014.03-2	-	-	-	-	-	-	-	-	-	-

DYNAMIC 3TIBASE

	GINGIVAL HEIGHT	α_s	α_c	α_s
		CH-5mm	CH-7mm	CH-9mm
R	-	-	-	-
NR	-	-	-	-

DYNAMIC SCANBODY (LAB/CLIN) DIGITAL ANALOG

SCANBODY	HEIGHT mm	ADAPTOR	SCREWDRIVER ADAPTOR	DIGITAL ANALOG
52.410.128.01-2	10	50.312.014.03-2 (IG-3mm)	43.621.415.01-2	34.612.014.01-2
-	-			
-	-			

DYNAMIC MILLING TOOL

DYNAMIC MILLING TOOL	SHANK	α_{di}
33.345.804.01-2	3	25°
33.445.804.01-2	4	
33.645.804.01-2	6	

SCANALOG

23.412.014.01-2

DYNAMIC SCREWS

DYNAMIC SCREW	HIGH DYNAMIC SCREW	DYNAMIC SCREWDRIVER	SCREWDRIVER LENGTH (mm)
41.314.067.01-2	41.314.105.01-2	43.618.201.01-2	18
		43.624.201.01-2	24
		43.632.201.01-2	32

STRAIGHT SCREWS

STRAIGHT SCREW	SCREWDRIVER Hex. 1.20
40.314.003.04-2	43.601.103.02-2

ANALOG	LAB SCANBODY
-	30.412.001.01-2

MULTI-UNIT

	GINGIVAL HEIGHT	GINGIVAL HEIGHT	GINGIVAL HEIGHT	GINGIVAL HEIGHT
	1 mm	2 mm	3 mm	4 mm
R	-	42.302.014.02-2	42.302.014.03-2	42.302.014.04-2

LIBRARY OPTIONS
GH = Gingival Height α_s - Standard maximum angulation
CH = Cement Height α_c - Captive maximum angulation
IG = Adaptor 3mm α_s - Direct to implant maximum angulation
R = Rotational / Non-Engaging
NR = Non Rotational / Engaging

STANDARD DYNAMIC TIBASE															
	GINGIVAL HEIGHT	α_s	α_c	GINGIVAL HEIGHT	α_s	α_c	GINGIVAL HEIGHT	α_s	α_c	GINGIVAL HEIGHT	α_s	α_c	GINGIVAL HEIGHT	α_s	α_c
	1.7 mm			2.5 mm			3 mm			4 mm			5 mm		
R	31.323.015.01-2	43°	23°	31.323.015.02-2	25°	15°	31.323.015.03-2	25°	-	31.323.015.04-2	20°	-	31.323.015.05-2	15°	-
NR	31.313.015.01-2			31.313.015.02-2			31.313.015.03-2			31.313.015.04-2			31.313.015.05-2		

DYNAMIC 3TIBASE															
	GINGIVAL HEIGHT	α_s	α_s	α_s	GINGIVAL HEIGHT	α_s	α_s	α_s	GINGIVAL HEIGHT	GINGIVAL HEIGHT	α_s	α_s	α_s		
	1 mm	CH+5mm	CH+ 7mm	CH+ 9mm	1.7 mm	CH+5mm	CH+ 7mm	CH+ 9mm	2.5 mm	3.5 mm	CH+5mm	CH+ 7mm	CH+ 9mm		
R	-	30°	25°	200°	31.323.015.21-2	30°	25°	10°	31.323.015.22-2	-	25°	20°	10°		
NR	31.313.015.27-2				31.313.015.21-2				31.313.015.22-2	31.313.015.26-2					

DYNAMIC SCANBODY (LAB/CLIN)					DIGITAL ANALOG		DYNAMIC MILLING TOOL			SCANALOG		SCANBODY OP		
SCANBODY	HEIGHT mm	ADAPTOR	SCREWDRIVER ADAPTOR	DIGITAL ANALOG	DYNAMIC MILLING TOOL	SHANK	α_{di}	SCANBODY	PEEK PINS	mm				
52.410.104.01-2	10	50.313.015.01-2	43.621.410.01-2	34.613.015.01-2	33.390.805.01-2	3	25°	23.413.015.01-2	54.315.015.21-2	49.414.000.01-2	6			
		50.313.015.03-2 (IG-3mm)	43.624.410.01-2		33.490.805.01-2	4			49.415.000.01-2	9				
52.412.104.01-2	12					33.690.805.01-2			6	49.416.000.01-2	13			

SCREWDRIVER 43.601.103.02-2

DYNAMIC SCREWS			
DYNAMIC SCREW	HIGH DYNAMIC SCREW	DYNAMIC SCREWDRIVER	SCREWDRIVER LENGTH (mm)
41.318.075.01-2	-	43.618.201.01-2	18
		43.624.201.01-2	24
		43.632.201.01-2	32

STRAIGHT SCREWS	
STRAIGHT SCREW	SCREWDRIVER Hex. 1.20
40.318.003.02-2	43.601.103.02-2

ANALOG	LAB SCANBODY
-	30.413.002.01-2

MULTI-UNIT				
	GINGIVAL HEIGHT	GINGIVAL HEIGHT	GINGIVAL HEIGHT	GINGIVAL HEIGHT
	1 mm	2 mm	3 mm	4 mm
R	42.303.015.01-2	42.303.015.02-2	42.303.015.03-2	42.303.015.04-2

LIBRARY OPTIONS
GH = Gingival Height α_s - Standard maximum angulation
CH = Cement Height α_c - Captive maximum angulation
IG = Adaptor 3mm α_{di} - Direct to implant maximum angulation
R = Rotational / Non-Engaging
NR = Non Rotational / Engaging

STANDARD DYNAMIC TIBASE															
	GINGIVAL HEIGHT	α_s	α_c	GINGIVAL HEIGHT	α_s	α_c	GINGIVAL HEIGHT	α_s	α_c	GINGIVAL HEIGHT	α_s	α_c	GINGIVAL HEIGHT	α_s	α_c
	0.8 mm			1.5 mm			mm			mm			mm		
R	31.322.016.01-2	45°	28°	31.322.016.02-2	25°	-	-	-	-	-	-	-	-	-	-
NR	31.312.016.01-2			31.312.016.02-2			-			-			-		

DYNAMIC 3TIBASE					
	GINGIVAL HEIGHT	α_s	α_s	α_s	
	1.5 mm	CH+5mm	CH+ 7mm	CH+ 9mm	
R	-	25°	25°	15°	
NR	31.312.016.22-2				

DYNAMIC SCANBODY (LAB/CLIN)					DIGITAL ANALOG		DYNAMIC MILLING TOOL		
SCANBODY	HEIGHT mm	ADAPTOR	SCREWDRIVER ADAPTOR	DIGITAL ANALOG	DYNAMIC MILLING TOOL	SHANK	α_{di}		
52.408.106.01-2	8	50.312.016.01-2	43.621.410.01-2	34.610.016.01-2	33.360.754.01-2	3	25°		
52.410.106.01-2	10	50.312.016.04-2 (IG-3mm)	43.624.410.01-2		33.460.754.01-2	4			
52.412.106.01-2	12		43.624.410.01-2		33.660.754.01-2	6			

DYNAMIC SCREWS			
DYNAMIC SCREW	HIGH DYNAMIC SCREW	DYNAMIC SCREWDRIVER	SCREWDRIVER LENGTH (mm)
41.316.071.01-2	-	43.618.201.01-2	18
		43.624.201.01-2	24
		43.632.201.01-2	32

STRAIGHT SCREWS	
STRAIGHT SCREW	SCREWDRIVER Hex. 1.27
40.316.005.05-2	43.601.105.01-2

ANALOG	LAB SCANBODY
-	30.412.001.01-2

MULTI-UNIT				
	GINGIVAL HEIGHT	GINGIVAL HEIGHT	GINGIVAL HEIGHT	GINGIVAL HEIGHT
	1 mm	2 mm	3 mm	4 mm
R	-	42.302.016.02-2	-	-

LIBRARY OPTIONS
GH = Gingival Height α_s - Standard maximum angulation
CH = Cement Height α_c - Captive maximum angulation
IG = Adaptor 3mm α_{di} - Direct to implant maximum angulation
R = Rotational / Non-Engaging
NR = Non Rotational / Engaging

STANDARD DYNAMIC TIBASE															
	GINGIVAL HEIGHT	α_s	α_c	GINGIVAL HEIGHT	α_s	α_c	GINGIVAL HEIGHT	α_s	α_c	GINGIVAL HEIGHT	α_s	α_c	GINGIVAL HEIGHT	α_s	α_c
	0.7 mm			1.5 mm			mm			mm			mm		
R	31.323.017.01-2	45°	24°	31.323.017.02-2	25°	-	-	-	-	-	-	-	-	-	-
NR	31.313.017.01-2			31.313.017.02-2			-	-	-	-	-	-	-	-	-

DYNAMIC 3TIBASE

	GINGIVAL HEIGHT	α_s	α_c	α_s
	0.7 mm	CH-5mm	CH- 7mm	CH- 9mm
R	31.323.017.21-2	30°	25°	15°
NR	31.313.017.21-2			

DYNAMIC SCANBODY (LAB/CLIN) DIGITAL ANALOG

SCANBODY	HEIGHT mm	ADAPTOR	SCREWDRIVER ADAPTOR	DIGITAL ANALOG
52.408.101.01-2	8	50.313.017.04-2 (IG-3mm)	43.621.410.01-2 43.624.410.01-2	34.613.017.01-2
52.410.101.01-2	10			
52.412.101.01-2	12			

DYNAMIC MILLING TOOL

DYNAMIC MILLING TOOL	SHANK	α_{di}
33.360.756.01-2	3	30°
33.460.756.01-2	4	
33.660.756.01-2	6	

DYNAMIC SCREWS

DYNAMIC SCREW	HIGH DYNAMIC SCREW	DYNAMIC SCREWDRIVER	SCREWDRIVER LENGTH (mm)
41.317.073.01-2	-	43.618.201.01-2	18
		43.624.201.01-2	24
		43.632.201.01-2	32

STRAIGHT SCREWS

STRAIGHT SCREW	SCREWDRIVER Hex. 1.27
40.317.005.01-2	43.601.105.01-2

ANALOG	LAB SCANBODY
-	30.413.002.01-2

MULTI-UNIT

	GINGIVAL HEIGHT	GINGIVAL HEIGHT	GINGIVAL HEIGHT	GINGIVAL HEIGHT
	1 mm	2 mm	3 mm	4 mm
R	-	42.303.017.02-2	-	-

LIBRARY OPTIONS
GH = Gingival Height α_s - Standard maximum angulation
CH = Cement Height α_c - Captive maximum angulation
IG = Adaptor 3mm α_{di} - Direct to implant maximum angulation
R = Rotational / Non-Engaging
NR = Non Rotational / Engaging

STANDARD DYNAMIC TIBASE															
	GINGIVAL HEIGHT	α_s	α_c	GINGIVAL HEIGHT	α_s	α_c	GINGIVAL HEIGHT	α_s	α_c	GINGIVAL HEIGHT	α_s	α_c	GINGIVAL HEIGHT	α_s	α_c
	1.2 mm			mm			mm			mm			mm		
R	31.324.018.01-2	39°	18°	-	-	-	-	-	-	-	-	-	-	-	-
NR	31.314.018.01-2			-	-	-	-	-	-	-	-	-	-	-	-

DYNAMIC 3TIBASE

	GINGIVAL HEIGHT	α_s	α_c	α_s
		CH-5mm	CH- 7mm	CH- 9mm
R	-	-	-	-
NR	-			

DYNAMIC SCANBODY (LAB/CLIN) DIGITAL ANALOG

SCANBODY	HEIGHT mm	ADAPTOR	SCREWDRIVER ADAPTOR	DIGITAL ANALOG
52.410.102.01-2	10	50.314.018.01-2	43.621.410.01-2 43.624.410.01-2	34.614.018.01-2
52.412.102.01-2	12			

DYNAMIC MILLING TOOL

DYNAMIC MILLING TOOL	SHANK	α_{di}
33.360.756.01-2	3	30°
33.460.756.01-2	4	
33.660.756.01-2	6	

DYNAMIC SCREWS

DYNAMIC SCREW	HIGH DYNAMIC SCREW	DYNAMIC SCREWDRIVER	SCREWDRIVER LENGTH (mm)
41.317.073.01-2	-	43.618.201.01-2	18
		43.624.201.01-2	24
		43.632.201.01-2	32

STRAIGHT SCREWS

STRAIGHT SCREW	SCREWDRIVER Hex. 1.27
40.317.005.01-2	43.601.105.01-2

ANALOG	LAB SCANBODY
-	30.413.002.01-2

LIBRARY OPTIONS
GH = Gingival Height α_s - Standard maximum angulation
CH = Cement Height α_c - Captive maximum angulation
IG = Adaptor 3mm α_{di} - Direct to implant maximum angulation
R = Rotational / Non-Engaging
NR = Non Rotational / Engaging

STANDARD DYNAMIC TIBASE															
	GINGIVAL HEIGHT	α_s	α_c	GINGIVAL HEIGHT	α_s	α_c	GINGIVAL HEIGHT	α_s	α_c	GINGIVAL HEIGHT	α_s	α_c	GINGIVAL HEIGHT	α_s	α_c
	0,8 mm			mm			mm			mm			mm		
R	31.322.019.01-2	45°	30°	-	-	-	-	-	-	-	-	-	-	-	-
NR	31.312.019.01-2			-	-	-	-	-	-	-	-	-	-	-	-

DYNAMIC 3TIBASE				
	GINGIVAL HEIGHT	α_s	α_c	α_d
		CH-5mm	CH-7mm	CH-9mm
R	-	-	-	-
NR	-	-	-	-

DYNAMIC SCANBODY (LAB/CLIN)				DIGITAL ANALOG
SCANBODY	HEIGHT mm	ADAPTOR	SCREWDRIVER ADAPTOR	DIGITAL ANALOG
52.410.105.01-2	10	50.312.019.01-2	43.621.415.01-2 43.624.410.01-2	34.612.019.01-2
52.412.105.01-2	12			

DYNAMIC MILLING TOOL		
DYNAMIC MILLING TOOL	SHANK	α_{di}
33.360.754.01-2	3	25°
33.460.754.01-2	4	
33.660.754.01-2	6	

DYNAMIC SCREWS			
DYNAMIC SCREW	HIGH DYNAMIC SCREW	DYNAMIC SCREWDRIVER	SCREWDRIVER LENGTH (mm)
41.316.071.01-2	-	43.618.201.01-2	18
		43.624.201.01-2	24
		43.632.201.01-2	32

STRAIGHT SCREWS	
STRAIGHT SCREW	SCREWDRIVER Hex. 1.27
40.316.005.05-2	43.601.105.01-2

ANALOG	LAB SCANBODY
-	30.412.001.01-2

LIBRARY OPTIONS
GH = Gingival Height α_s - Standard maximum angulation
CH = Cement Height α_c - Captive maximum angulation
IG = Adaptor 3mm α_d - Direct to implant maximum angulation
R = Rotational / Non-Engaging
NR = Non Rotational / Engaging

STANDARD DYNAMIC TIBASE															
	GINGIVAL HEIGHT	α_s	α_c	GINGIVAL HEIGHT	α_s	α_c	GINGIVAL HEIGHT	α_s	α_c	GINGIVAL HEIGHT	α_s	α_c	GINGIVAL HEIGHT	α_s	α_c
	0,6 mm			mm			mm			mm			mm		
R	31.323.020.01-2	45°	30°	-	-	-	-	-	-	-	-	-	-	-	-
NR	-			-	-	-	-	-	-	-	-	-	-	-	-

DYNAMIC 3TIBASE				
	GINGIVAL HEIGHT	α_s	α_c	α_d
		CH-5mm	CH-7mm	CH-9mm
R	-	-	-	-
NR	-	-	-	-

DYNAMIC SCANBODY (LAB/CLIN)				DIGITAL ANALOG
SCANBODY	HEIGHT mm	ADAPTOR	SCREWDRIVER ADAPTOR	DIGITAL ANALOG
52.408.112.01-2	8	50.313.020.01-2	43.620.411.01-2	34.613.020.01-2
-	10			
-	12			

DYNAMIC MILLING TOOL		
DYNAMIC MILLING TOOL	SHANK	α_{di}
33.390.716.01-2	3	30°
33.490.716.01-2	4	
33.690.716.01-2	6	

DYNAMIC SCREWS			
DYNAMIC SCREW	HIGH DYNAMIC SCREW	DYNAMIC SCREWDRIVER	SCREWDRIVER LENGTH (mm)
41.316.044.01-2	-	43.618.201.01-2	18
		43.624.201.01-2	24
		43.632.201.01-2	32

STRAIGHT SCREWS	
STRAIGHT SCREW	SCREWDRIVER Hex. 1.27
40.316.005.06-2	43.601.105.01-2

ANALOG	LAB SCANBODY
-	30.413.005.01-2

LIBRARY OPTIONS
GH = Gingival Height α_s - Standard maximum angulation
CH = Cement Height α_c - Captive maximum angulation
IG = Adaptor 3mm α_d - Direct to implant maximum angulation
R = Rotational / Non-Engaging
NR = Non Rotational / Engaging

STANDARD DYNAMIC TIBASE															
	GINGIVAL HEIGHT	α_s	α_c	GINGIVAL HEIGHT	α_s	α_c	GINGIVAL HEIGHT	α_s	α_c	GINGIVAL HEIGHT	α_s	α_c	GINGIVAL HEIGHT	α_s	α_c
	1.5 mm			2 mm			3 mm			4 mm			5 mm		
R	31.322.021.01-2	43°	24°	31.322.021.02-2	25°	20°	31.322.021.03-2	20°	25°	31.322.021.04-2	15°	25°	31.322.021.05-2	15°	20°
NR	31.312.021.01-2			31.312.021.02-2			31.312.021.03-2			31.312.021.04-2			31.312.021.05-2		

DYNAMIC 3TIBASE									
	GINGIVAL HEIGHT	α_s	α_s	α_s	GINGIVAL HEIGHT	α_s	α_s	α_s	
	1.5 mm	CH-5mm	CH- 7mm	CH- 9mm	3 mm	CH-5mm	H- 7mm	CH- 9mm	
R	31.322.021.21-2	25°	20°	10°	31.322.021.23-2	25°	20°	15°	
NR	31.312.021.21-2				31.312.021.23-2				

DYNAMIC SCANBODY (LAB/CLIN)					DIGITAL ANALOG	DYNAMIC MILLING TOOL			SCANALOG	SCANBODY OP		
SCANBODY	HEIGHT mm	ADAPTOR	SCREWDRIVER ADAPTOR	DIGITAL ANALOG	DYNAMIC MILLING TOOL	SHANK	α_{di}		SCANALOG	SCANBODY	PEEK PINS	mm
52.410.103.01-2	10	50.312.021.03-2 (IG-3mm)	43.621.410.01-2 43.624.410.01-2	34.612.021.01-2	33.335.754.01-2	3	25°	23.412.021.01-2		54.315.021.21-2	49.414.000.01-2	6
					33.435.754.01-2	4				49.415.000.01-2	9	
52.412.103.01-2	12				33.635.754.01-2	6				49.416.000.01-2	13	

SCREWDRIVER 43.625.108.01-2

DYNAMIC SCREWS				STRAIGHT SCREWS		
DYNAMIC SCREW	HIGH DYNAMIC SCREW	DYNAMIC SCREWDRIVER	SCREWDRIVER LENGTH (mm)	STRAIGHT SCREW	ANALOG	LAB SCANBODY
41.316.073.01-2	41.316.108.01-2	43.618.201.01-2	18	40.316.008.02-2	22.612.021.01-2	30.412.001.01-2
		43.624.201.01-2	24			
		43.632.201.01-2	32			

MULTI-UNIT				
	GINGIVAL HEIGHT	GINGIVAL HEIGHT	GINGIVAL HEIGHT	GINGIVAL HEIGHT
	1 mm	2 mm	3 mm	4 mm
R	42.302.021.01-2	42.302.021.02-2	42.302.021.03-2	42.302.021.04-2

LIBRARY OPTIONS
GH = Gingival Height α_s - Standard maximum angulation
CH = Cement Height α_c - Captive maximum angulation
IG = Adaptor 3mm α_d - Direct to implant maximum angulation
R = Rotational / Non-Engaging
NR = Non Rotational / Engaging

STANDARD DYNAMIC TIBASE															
	GINGIVAL HEIGHT	α_s	α_c	GINGIVAL HEIGHT	α_s	α_c	GINGIVAL HEIGHT	α_s	α_c	GINGIVAL HEIGHT	α_s	α_c	GINGIVAL HEIGHT	α_s	α_c
	1.3 mm			2 mm			3 mm			4 mm			5 mm		
R	31.323.022.01-2	40°	19°	31.323.022.02-2	25°	14°	31.323.022.03-2	20°	30°	31.323.022.04-2	15	30	31.323.022.05-2	15°	20°
NR	31.313.022.01-2			31.313.022.02-2			31.313.022.03-2			31.313.022.04-2			31.313.022.05-2		

DYNAMIC 3TIBASE									
	GINGIVAL HEIGHT	α_s	α_s	α_s	GINGIVAL HEIGHT	α_s	α_s	α_s	
	1.3 mm	CH-5mm	CH- 7mm	CH- 9mm	3 mm	CH-5mm	CH- 7mm	CH- 9mm	
R	31.323.022.21-2	30°	25°	10°	31.323.022.23-2	20°	20°	10°	
NR	31.313.022.21-2				31.313.022.23-2				

DYNAMIC SCANBODY (LAB/CLIN)					DIGITAL ANALOG	DYNAMIC MILLING TOOL			SCANALOG	SCANBODY OP		
SCANBODY	HEIGHT mm	ADAPTOR	SCREWDRIVER ADAPTOR	DIGITAL ANALOG	DYNAMIC MILLING TOOL	SHANK	α_{di}		SCANALOG	SCANBODY	PEEK PINS	mm
52.408.101.01-2	8	50.313.022.01-2 50.313.022.03-2 (IG-3mm)	43.621.410.01-2 43.624.410.01-2	34.613.022.01-2	33.335.758.01-2	3	30°	23.413.022.01-2		54.315.022.21-2	49.414.000.01-2	6
52.410.101.01-2	10				33.435.758.01-2	4				49.415.000.01-2	9	
52.412.101.01-2	12				33.635.758.01-2	6				49.416.000.01-2	13	

SCREWDRIVER 43.625.108.01-2

DYNAMIC SCREWS				STRAIGHT SCREWS		
DYNAMIC SCREW	HIGH DYNAMIC SCREW	DYNAMIC SCREWDRIVER	SCREWDRIVER LENGTH (mm)	STRAIGHT SCREW	ANALOG	LAB SCANBODY
41.320.075.01-2	41.320.117.01-2	43.618.201.01-2	18	40.320.008.02-2	22.613.022.01-2	30.413.002.01-2
		43.624.201.01-2	24			
		43.632.201.01-2	32			

MULTI-UNIT				
	GINGIVAL HEIGHT	GINGIVAL HEIGHT	GINGIVAL HEIGHT	GINGIVAL HEIGHT
	1 mm	2 mm	3 mm	4 mm
R	42.303.022.01-2	42.303.022.02-2	42.303.022.03-2	42.303.022.04-2

LIBRARY OPTIONS
GH = Gingival Height α_s - Standard maximum angulation
CH = Cement Height α_c - Captive maximum angulation
IG = Adaptor 3mm α_d - Direct to implant maximum angulation
R = Rotational / Non-Engaging
NR = Non Rotational / Engaging

STANDARD DYNAMIC TIBASE															
	GINGIVAL HEIGHT	α_s	α_c	GINGIVAL HEIGHT	α_s	α_c	GINGIVAL HEIGHT	α_s	α_c	GINGIVAL HEIGHT	α_s	α_c	GINGIVAL HEIGHT	α_s	α_c
	0.3 mm			mm			mm			mm			mm		
R	31.322.023.01-2	45°	30°	-	-	-	-	-	-	-	-	-	-	-	-
NR	31.312.023.01-2			-	-	-	-	-	-	-	-	-	-	-	-

DYNAMIC 3TIBASE				
	GINGIVAL HEIGHT	α_s	α_c	α_s
		CH-5mm	CH-7mm	CH-9mm
R	-	-	-	-
NR	-	-	-	-

DYNAMIC SCANBODY (LAB/CLIN)				DIGITAL ANALOG
SCANBODY	HEIGHT mm	ADAPTOR	SCREWDRIVER ADAPTOR	DIGITAL ANALOG
52.410.103.01-2	10	50.312.023.01-2	43.621.410.01-2 43.624.410.01-2	34.612.023.01-2
52.412.103.01-2	12			

DYNAMIC MILLING TOOL		
DYNAMIC MILLING TOOL	SHANK	α_{di}
33.390.805.01-2	3	25°
33.490.805.01-2	4	
33.690.805.01-2	6	

SCANALOG
23.412.023.01-2

DYNAMIC SCREWS			
DYNAMIC SCREW	HIGH DYNAMIC SCREW	DYNAMIC SCREWDRIVER	SCREWDRIVER LENGTH (mm)
41.316.059.01-2	-	43.618.201.01-2	18
		43.624.201.01-2	24
		43.632.201.01-2	32

STRAIGHT SCREWS	
STRAIGHT SCREW	SCREWDRIVER UNIGRIP
40.316.008.01-2	43.601.108.01-2

ANALOG	LAB SCANBODY
22.612.023.01-2	30.412.001.01-2

LIBRARY OPTIONS
GH = Gingival Height α_s - Standard maximum angulation
CH = Cement Height α_c - Captive maximum angulation
IG = Adaptor 3mm α_s - Direct to implant maximum angulation
R = Rotational / Non-Engaging
NR = Non Rotational / Engaging

STANDARD DYNAMIC TIBASE															
	GINGIVAL HEIGHT	α_s	α_c	GINGIVAL HEIGHT	α_s	α_c	GINGIVAL HEIGHT	α_s	α_c	GINGIVAL HEIGHT	α_s	α_c	GINGIVAL HEIGHT	α_s	α_c
	0.3 mm			0.5 mm			mm			mm			mm		
R	31.323.024.01-2	45°	30°	31.323.024.02-2	30°	30°	-	-	-	-	-	-	-	-	-
NR	31.313.024.01-2			31.313.024.02-2			-	-	-	-	-	-	-	-	-

DYNAMIC 3TIBASE												
	GINGIVAL HEIGHT	GINGIVAL HEIGHT	GINGIVAL HEIGHT	GINGIVAL HEIGHT	α_s	α_c	α_s	GINGIVAL HEIGHT	GINGIVAL HEIGHT	α_s	α_c	α_s
	0.3 mm	0.5 mm	1 mm	2 mm	CH 5mm	CH 7mm	CH 9mm	3 mm	4 mm	CH 5mm	CH 7mm	CH 9mm
R	31.323.024.21-2	31.323.024.22-2	31.323.024.23-2	31.323.024.24-2	30°	25°	10°	31.323.024.25-2	31.323.024.26-2	25°	20°	15°
NR	31.313.024.21-2	31.313.024.22-2	31.313.024.23-2	31.313.024.24-2				31.313.024.25-2	31.313.024.26-2			

DYNAMIC SCANBODY (LAB/CLIN)				DIGITAL ANALOG
SCANBODY	HEIGHT mm	ADAPTOR	SCREWDRIVER ADAPTOR	DIGITAL ANALOG
52.408.101.01-2	8	50.313.024.01-2	43.621.410.01-2 43.624.410.01-2	34.613.024.01-2
52.410.101.01-2	10			
52.412.101.01-2	12			

DYNAMIC MILLING TOOL		
DYNAMIC MILLING TOOL	SHANK	α_{di}
33.390.716.01-2	3	30°
33.490.716.01-2	4	
33.690.716.01-2	6	

SCANALOG
23.413.024.01-2

SCANBODY OP		
SCANBODY	PEEK PINS	mm
54.315.024.21-2	49.414.000.01-2	6
	49.415.000.01-2	9
	49.416.000.01-2	13

SCREWDRIVER 43.625.108.01-2

DYNAMIC SCREWS			
DYNAMIC SCREW	HIGH DYNAMIC SCREW	DYNAMIC SCREWDRIVER	SCREWDRIVER LENGTH (mm)
41.320.060.01-2	-	43.618.201.01-2	18
		43.624.201.01-2	24
		43.632.201.01-2	32

STRAIGHT SCREWS	
STRAIGHT SCREW	SCREWDRIVER UNIGRIP
40.320.008.01-2	43.601.108.01-2

ANALOG	LAB SCANBODY
22.613.024.01-2	30.413.002.01-2

MULTI-UNIT				
	GINGIVAL HEIGHT	GINGIVAL HEIGHT	GINGIVAL HEIGHT	GINGIVAL HEIGHT
	1 mm	2 mm	3 mm	4 mm
R	-	42.303.024.02-2	42.303.024.03-2	-

LIBRARY OPTIONS
GH = Gingival Height α_s - Standard maximum angulation
CH = Cement Height α_c - Captive maximum angulation
IG = Adaptor 3mm α_s - Direct to implant maximum angulation
R = Rotational / Non-Engaging
NR = Non Rotational / Engaging

STANDARD DYNAMIC TIBASE															
	GINGIVAL HEIGHT	α_s	α_c	GINGIVAL HEIGHT	α_s	α_c	GINGIVAL HEIGHT	α_s	α_c	GINGIVAL HEIGHT	α_s	α_c	GINGIVAL HEIGHT	α_s	α_c
	0.3 mm			mm			mm			mm			mm		
R	31.323.025.01-2	45°	30°	-	-	-	-	-	-	-	-	-	-	-	-
NR	-			-	-	-	-	-	-	-	-	-	-	-	-

DYNAMIC 3TIBASE

	GINGIVAL HEIGHT	α_s	α_c	α_s
	0.3 mm	CH-5mm	CH- 7mm	CH- 9mm
R	31.323.025.21-2	30°	25°	10°
NR	-			

DYNAMIC SCANBODY (LAB/CLIN)

SCANBODY	HEIGHT mm	ADAPTOR	SCREWDRIVER ADAPTOR	DIGITAL ANALOG
52.408.112.01-2	8	50.313.025.02-2	43.620.411.01-2	34.613.025.01-2
52.410.111.01-2	10	50.313.025.01-2	43.621.410.01-2 43.624.410.01-2	

DIGITAL ANALOG

DYNAMIC MILLING TOOL

DYNAMIC MILLING TOOL	SHANK	α_{di}
33.390.716.01-2	3	30°
33.490.716.01-2	4	
33.690.716.01-2	6	

SCANALOG

23.413.025.01-2

REFERENCE SCANBODY

SCANBODY	PEEK PINS	mm	
54.322.025.31-2	49.414.000.01-2	6	
	49.415.000.01-2	9	
	49.416.000.01-2	13	
	CAPS		mm
	49.418.000.01-2	3.8	
	49.419.000.01-2	6	
49.420.000.01-2	8		

SCREWDRIVER: 43.625.108.01-2

DYNAMIC SCREWS

DYNAMIC SCREW	HIGH DYNAMIC SCREW	DYNAMIC SCREWDRIVER	SCREWDRIVER LENGTH (mm)
41.314.039.01-2	-	43.618.201.01-2	18
		43.624.201.01-2	24
		43.632.201.01-2	32

STRAIGHT SCREWS

STRAIGHT SCREW	SCREWDRIVER UNIGRIP
40.314.008.01-2	43.601.108.01-2

ANALOG	LAB SCANBODY
22.613.025.01-2	30.413.005.01-2

LIBRARY OPTIONS

- GH = Gingival Height
- CH = Cement Height
- IG = Adaptor 3mm
- α_s = Standard maximum angulation
- α_c = Captive maximum angulation
- α_{di} = Direct to implant maximum angulation
- R = Rotational / Non-Engaging
- NR = Non Rotational / Engaging

STANDARD DYNAMIC TIBASE															
	GINGIVAL HEIGHT	α_s	α_c	GINGIVAL HEIGHT	α_s	α_c	GINGIVAL HEIGHT	α_s	α_c	GINGIVAL HEIGHT	α_s	α_c	GINGIVAL HEIGHT	α_s	α_c
	0.5 mm			1.2 mm			mm			mm			mm		
R	31.322.026.01-2	45°	29°	31.322.026.02-2	25°	22°	-	-	-	-	-	-	-	-	-
NR	31.312.026.01-2			31.312.026.02-2			-	-	-	-	-	-	-	-	-

DYNAMIC 3TIBASE

	GINGIVAL HEIGHT	α_s	α_c	α_s
	0.5 mm	CH-5mm	CH- 7mm	CH- 9mm
R	31.322.026.21-2	25°	20°	10°
NR	31.312.026.21-2			

DYNAMIC SCANBODY (LAB/CLIN)

SCANBODY	HEIGHT mm	ADAPTOR	SCREWDRIVER ADAPTOR	DIGITAL ANALOG
52.410.108.01-2	10	50.312.026.04-2 (IG-3mm)	43.621.410.01-2 43.624.410.01-2	34.612.026.01-2
52.412.108.01-2	12			

DIGITAL ANALOG

DYNAMIC MILLING TOOL

DYNAMIC MILLING TOOL	SHANK	α_{di}
33.390.805.01-2	3	25°
33.490.805.01-2	4	
33.690.805.01-2	6	

DYNAMIC SCREWS

DYNAMIC SCREW	HIGH DYNAMIC SCREW	DYNAMIC SCREWDRIVER	SCREWDRIVER LENGTH (mm)
41.318.075.01-2	-	43.618.201.01-2	18
		43.624.201.01-2	24
		43.632.201.01-2	32

STRAIGHT SCREWS

STRAIGHT SCREW	SCREWDRIVER UNIGRIP
40.318.008.01-2	43.601.108.01-2

ANALOG	LAB SCANBODY
22.612.026.01-2	30.412.001.01-2

LIBRARY OPTIONS

- GH = Gingival Height
- CH = Cement Height
- IG = Adaptor 3mm
- α_s = Standard maximum angulation
- α_c = Captive maximum angulation
- α_{di} = Direct to implant maximum angulation
- R = Rotational / Non-Engaging
- NR = Non Rotational / Engaging

STANDARD DYNAMIC TIBASE															
	GINGIVAL HEIGHT	α_s	α_c	GINGIVAL HEIGHT	α_s	α_c	GINGIVAL HEIGHT	α_s	α_c	GINGIVAL HEIGHT	α_s	α_c	GINGIVAL HEIGHT	α_s	α_c
	0.3 mm			1.2 mm			mm			mm			mm		
R	31.323.027.01-2	35°	29°	31.323.027.02-2	25°	22°	-	-	-	-	-	-	-	-	-
NR	31.313.027.01-2			31.313.027.02-2			-	-	-	-	-				

DYNAMIC 3TIBASE				
	GINGIVAL HEIGHT	α_s	α_c	α_s
	0.3 mm	CH-5mm	CH- 7mm	CH- 9mm
R	31.323.027.21-2	25°	20°	10°
NR	31.313.027.21-2			

DYNAMIC SCANBODY (LAB/CLIN)				DIGITAL ANALOG
SCANBODY	HEIGHT mm	ADAPTOR	SCREWDRIVER ADAPTOR	DIGITAL ANALOG
52.410.109.01-2	10	50.313.027.01-2	43.621.410.01-2 43.624.410.01-2	34.613.027.01-2
52.412.109.01-2	12			

DYNAMIC MILLING TOOL		
DYNAMIC MILLING TOOL	SHANK	α_{di}
33.390.958.01-2	3	30°
33.490.958.01-2	4	
33.690.958.01-2	6	

DYNAMIC SCREWS			
DYNAMIC SCREW	HIGH DYNAMIC SCREW	DYNAMIC SCREWDRIVER	SCREWDRIVER LENGTH (mm)
41.320.090.01-2	-	43.618.201.01-2	18
		43.624.201.01-2	24
		43.632.201.01-2	32

STRAIGHT SCREWS	
STRAIGHT SCREW	SCREWDRIVER UNIGRIP
40.320.008.03-2	43.601.108.01-2

ANALOG	LAB SCANBODY
22.613.027.01-2	30.413.002.01-2

LIBRARY OPTIONS

GH = Gingival Height α_s - Standard maximum angulation
CH = Cement Height α_c - Captive maximum angulation
IG = Adaptor 3mm α_s - Direct to implant maximum angulation
R = Rotational / Non-Engaging
NR = Non Rotational / Engaging

STANDARD DYNAMIC TIBASE															
	GINGIVAL HEIGHT	α_s	α_c	GINGIVAL HEIGHT	α_s	α_c	GINGIVAL HEIGHT	α_s	α_c	GINGIVAL HEIGHT	α_s	α_c	GINGIVAL HEIGHT	α_s	α_c
	0.3 mm			mm			mm			mm			mm		
R	31.324.028.01-2	35°	30°	-	-	-	-	-	-	-	-	-	-	-	-
NR	31.314.028.01-2			-	-	-	-	-	-						

DYNAMIC 3TIBASE				
	GINGIVAL HEIGHT	α_s	α_c	α_s
		CH-5mm	CH- 7mm	CH- 9mm
R	-	-	-	-
NR	-	-	-	-

DYNAMIC SCANBODY (LAB/CLIN)				DIGITAL ANALOG
SCANBODY	HEIGHT mm	ADAPTOR	SCREWDRIVER ADAPTOR	DIGITAL ANALOG
52.410.109.01-2	10	50.314.028.01-2	43.621.410.01-2 43.624.410.01-2	34.614.028.01-2
52.412.109.01-2	12			

DYNAMIC MILLING TOOL		
DYNAMIC MILLING TOOL	SHANK	α_{di}
33.390.958.01-2	3	30°
33.490.958.01-2	4	
33.690.958.01-2	6	

DYNAMIC SCREWS			
DYNAMIC SCREW	HIGH DYNAMIC SCREW	DYNAMIC SCREWDRIVER	SCREWDRIVER LENGTH (mm)
41.320.090.01-2	-	43.618.201.01-2	18
		43.624.201.01-2	24
		43.632.201.01-2	32

STRAIGHT SCREWS	
STRAIGHT SCREW	SCREWDRIVER UNIGRIP
40.320.008.03-2	43.601.108.01-2

ANALOG	LAB SCANBODY
22.614.028.01-2	30.413.002.01-2

LIBRARY OPTIONS

GH = Gingival Height α_s - Standard maximum angulation
CH = Cement Height α_c - Captive maximum angulation
IG = Adaptor 3mm α_s - Direct to implant maximum angulation
R = Rotational / Non-Engaging
NR = Non Rotational / Engaging

STANDARD DYNAMIC TIBASE															
	GINGIVAL HEIGHT	α_s	α_c	GINGIVAL HEIGHT	α_s	α_c	GINGIVAL HEIGHT	α_s	α_c	GINGIVAL HEIGHT	α_s	α_c	GINGIVAL HEIGHT	α_s	α_c
	1.2 mm			2 mm			3 mm			4 mm			mm		
R	31.322.029.01-2	30°	23°	31.322.029.02-2	25°	15°	31.322.029.03-2	20	25	31.322.029.04-2	15°	25°	-	-	-
NR	31.312.029.01-2			31.312.029.02-2			31.312.029.03-2			31.312.029.04-2			-	-	-

DYNAMIC 3TIBASE				
	GINGIVAL HEIGHT	α_s	α_c	α_s
	2 mm	CH-5mm	CH- 7mm	CH- 9mm
R	-	25°	20°	15°
NR	31.312.029.22-2			

DYNAMIC SCANBODY (LAB/CLIN)					DIGITAL ANALOG	DYNAMIC MILLING TOOL			SCANALOG
SCANBODY	HEIGHT mm	ADAPTOR	SCREWDRIVER ADAPTOR	DIGITAL ANALOG	DYNAMIC MILLING TOOL	SHANK	α_{di}		
52.410.103.01-2	10	50.312.029.01-2	43.621.410.01-2 43.624.410.01-2	34.613.029.01-2	33.345.804.01-2	3	20°	23.412.029.01-2	
					50.312.029.03-2 (IG-3mm)	33.445.804.01-2			
52.412.103.01-2	12		33.645.804.01-2	6					

DYNAMIC SCREWS				STRAIGHT SCREWS		ANALOG		LAB SCANBODY	
DYNAMIC SCREW	HIGH DYNAMIC SCREW	DYNAMIC SCREWDRIVER	SCREWDRIVER LENGTH (mm)	STRAIGHT SCREW	SCREWDRIVER Hex. 1.20				
41.316.094.01-2	41.316.132.01-2	43.618.201.01-2	18	40.316.003.02-2	43.601.103.02-2	-		30.412.001.01-2	
		43.624.201.01-2	24						
		43.632.201.01-2	32						

MULTI-UNIT				
	GINGIVAL HEIGHT	GINGIVAL HEIGHT	GINGIVAL HEIGHT	GINGIVAL HEIGHT
	1 mm	2 mm	3 mm	4 mm
R	42.302.029.01-2	42.302.029.02-2	42.302.029.03-2	42.302.029.04-2

LIBRARY OPTIONS

GH = Gingival Height α_s - Standard maximum angulation
CH = Cement Height α_c - Captive maximum angulation
IG = Adaptor 3mm α_d - Direct to implant maximum angulation
R = Rotational / Non-Engaging
NR = Non Rotational / Engaging

STANDARD DYNAMIC TIBASE															
	GINGIVAL HEIGHT	α_s	α_c	GINGIVAL HEIGHT	α_s	α_c	GINGIVAL HEIGHT	α_s	α_c	GINGIVAL HEIGHT	α_s	α_c	GINGIVAL HEIGHT	α_s	α_c
	1.1 mm			2 mm			3 mm			4 mm			mm		
R	31.323.030.01-2	42°	25°	31.323.030.02-2	25°	15°	31.323.030.03-2	20°	30°	31.323.030.04-2	15°	30°	-	-	-
NR	31.313.030.01-2			31.313.030.02-2			31.313.030.03-2			31.313.030.04-2			-	-	-

DYNAMIC 3TIBASE								
	GINGIVAL HEIGHT	α_s	α_c	α_s	GINGIVAL HEIGHT	α_s	α_c	α_s
	1.1 mm	CH-5mm	CH- 7mm	CH- 9mm	3 mm	CH-5mm	CH- 7mm	CH- 9mm
R	31.323.030.21-2	25°	20°	10°	31.323.030.23-2	25°	20°	10°
NR	31.313.030.21-2				31.313.030.23-2			

DYNAMIC SCANBODY (LAB/CLIN)				DIGITAL ANALOG	DYNAMIC MILLING TOOL			SCANALOG	SCANBODY OP			
SCANBODY	HEIGHT mm	ADAPTOR	SCREWDRIVER ADAPTOR	DIGITAL ANALOG	DYNAMIC MILLING TOOL	SHANK	α_{di}		SCANBODY	PEEK PINS	mm	
52.408.101.01-2	8	50.313.030.01-2	43.621.410.01-2 43.624.410.01-2	34.613.030.01-2	33.345.808.01-2	3	30°	23.413.030.01-2	54.315.030.21-2	49.414.000.01-2	6	
52.410.101.01-2	10				50.313.030.03-2 (IG-3mm)	33.445.808.01-2				4	49.415.000.01-2	9
52.412.101.01-2	12				33.645.808.01-2	6				49.416.000.01-2	13	

SCREWDRIVER 43.601.103.02-2

DYNAMIC SCREWS				STRAIGHT SCREWS		ANALOG		LAB SCANBODY	
DYNAMIC SCREW	HIGH DYNAMIC SCREW	DYNAMIC SCREWDRIVER	SCREWDRIVER LENGTH (mm)	STRAIGHT SCREW	SCREWDRIVER Hex. 1.20				
41.320.079.01-2	41.320.125.01-2	43.618.201.01-2	18	40.320.003.04-2	43.601.103.02-2	-		30.413.002.01-2	
		43.624.201.01-2	24						
		43.632.201.01-2	32						

MULTI-UNIT					
	GINGIVAL HEIGHT	GINGIVAL HEIGHT	GINGIVAL HEIGHT	GINGIVAL HEIGHT	GINGIVAL HEIGHT
	1 mm	2 mm	3 mm	4 mm	5 mm
R	42.303.030.01-2	42.303.030.02-2	42.303.030.03-2	42.303.030.04-2	42.303.030.05-2

LIBRARY OPTIONS

GH = Gingival Height α_s - Standard maximum angulation
CH = Cement Height α_c - Captive maximum angulation
IG = Adaptor 3mm α_d - Direct to implant maximum angulation
R = Rotational / Non-Engaging
NR = Non Rotational / Engaging

STANDARD DYNAMIC TIBASE															
	GINGIVAL HEIGHT	α_s	α_c	GINGIVAL HEIGHT	α_s	α_c	GINGIVAL HEIGHT	α_s	α_c	GINGIVAL HEIGHT	α_s	α_c	GINGIVAL HEIGHT	α_s	α_c
	1.3 mm			2 mm			3 mm			4 mm			mm		
R	31.322.033.01-2	38°	18°	31.322.033.02-2	20°	14°	31.322.033.03-2	15°	25°	31.322.033.04-2	15°	25°	-	-	-
NR	31.312.033.01-2			31.312.033.02-2			31.312.033.03-2			31.312.033.04-2			-	-	-

DYNAMIC 3TIBASE									
	GINGIVAL HEIGHT	α_s	α_s	α_s	GINGIVAL HEIGHT	α_s	α_s	α_s	
	1.3 mm	CH-5mm	CH- 7mm	CH- 9mm	3 mm	CH-5mm	CH- 7mm	CH- 9mm	
R	31.322.033.21-2	25°	20°	10°	31.322.033.23-2	20°	15°	10°	
NR	31.312.033.21-2				31.312.033.23-2				

DYNAMIC SCANBODY (LAB/CLIN)					DIGITAL ANALOG	DYNAMIC MILLING TOOL	SCANALOG	SCANBODY OP			
SCANBODY	HEIGHT mm	ADAPTOR	SCREWDRIVER ADAPTOR	DIGITAL ANALOG	DYNAMIC MILLING TOOL	SHANK	α_{di}	SCANBODY	PEEK PINS	mm	
52.408.106.01-2	8	50.312.033.03-2 (IG-3mm)	43.621.410.01-2 43.624.410.01-2	34.612.033.01-2	33.315.804.01-2	3	25°	23.412.033.01-2	54.315.033.21-2	49.414.000.01-2	6
52.410.106.01-2	10				33.415.804.01-2	4				49.415.000.01-2	9
52.412.106.01-2	12				33.615.804.01-2	6				49.416.000.01-2	13

SCREWDRIVER 43.601.107.01-2

DYNAMIC SCREWS				STRAIGHT SCREWS		ANALOG		LAB SCANBODY	
DYNAMIC SCREW	HIGH DYNAMIC SCREW	DYNAMIC SCREWDRIVER	SCREWDRIVER LENGTH (mm)	STRAIGHT SCREW	SCREWDRIVER TORX T6				
41.316.078.01-2	41.316.124.01-2	43.618.201.01-2	18	40.316.007.01-2	43.601.107.01-2	22.612.033.01-2	30.412.001.01-2		
		43.624.201.01-2	24						
		43.632.201.01-2	32						

MULTI-UNIT				
	GINGIVAL HEIGHT	GINGIVAL HEIGHT	GINGIVAL HEIGHT	GINGIVAL HEIGHT
	1 mm	2 mm	3 mm	4 mm
R	42.302.033.01-2	42.302.033.02-2	42.302.033.03-2	42.302.033.04-2

LIBRARY OPTIONS	
GH = Gingival Height	α_s - Standard maximum angulation
CH = Cement Height	α_c - Captive maximum angulation
IG = Adaptor 3mm	α_{di} - Direct to implant maximum angulation
	R = Rotational / Non-Engaging
	NR = Non Rotational / Engaging

STANDARD DYNAMIC TIBASE															
	GINGIVAL HEIGHT	α_s	α_c	GINGIVAL HEIGHT	α_s	α_c	GINGIVAL HEIGHT	α_s	α_c	GINGIVAL HEIGHT	α_s	α_c	GINGIVAL HEIGHT	α_s	α_c
	1.1 mm			2 mm			3 mm			4 mm			mm		
R	31.323.035.01-2	39°	18°	31.323.035.02-2	20°	14°	31.323.035.03-2	15°	30°	31.323.035.04-2	15°	30°	-	-	-
NR	31.313.035.01-2			31.313.035.02-2			31.313.035.03-2			31.313.035.04-2			-	-	-

DYNAMIC 3TIBASE									
	GINGIVAL HEIGHT	α_s	α_s	α_s	GINGIVAL HEIGHT	α_s	α_s	α_s	
	1.1 mm	CH-5mm	CH- 7mm	CH- 9mm	3 mm	CH-5mm	CH- 7mm	CH- 9mm	
R	31.323.035.21-2	25°	20°	10°	31.323.035.23-2	20°	15°	10°	
NR	31.313.035.21-2				31.313.035.23-2				

DYNAMIC SCANBODY (LAB/CLIN)					DIGITAL ANALOG	DYNAMIC MILLING TOOL	SCANALOG	SCANBODY OP			
SCANBODY	HEIGHT mm	ADAPTOR	SCREWDRIVER ADAPTOR	DIGITAL ANALOG	DYNAMIC MILLING TOOL	SHANK	α_{di}	SCANBODY	PEEK PINS	mm	
52.410.107.01-2	10	50.313.035.01-2 50.313.035.03-2 (IG-3mm)	43.621.410.01-2 43.624.410.01-2	34.613.035.01-2	33.315.804.01-2	3	25°	23.413.035.01-2	54.315.035.21-2	49.414.000.01-2	6
					33.415.804.01-2	4				49.415.000.01-2	9
52.412.107.01-2	12				33.615.804.01-2	6				49.416.000.01-2	13

SCREWDRIVER 43.601.107.01-2

DYNAMIC SCREWS				STRAIGHT SCREWS		ANALOG		LAB SCANBODY	
DYNAMIC SCREW	HIGH DYNAMIC SCREW	DYNAMIC SCREWDRIVER	SCREWDRIVER LENGTH (mm)	STRAIGHT SCREW	SCREWDRIVER TORX T6				
41.316.078.01-2	41.316.124.01-2	43.618.201.01-2	18	40.316.007.01-2	43.601.107.01-2	22.613.035.01-2	30.413.002.01-2		
		43.624.201.01-2	24						
		43.632.201.01-2	32						

MULTI-UNIT				
	GINGIVAL HEIGHT	GINGIVAL HEIGHT	GINGIVAL HEIGHT	GINGIVAL HEIGHT
	1 mm	2 mm	3 mm	4 mm
R	42.303.035.01-2	42.303.035.02-2	42.303.035.03-2	42.303.035.04-2

LIBRARY OPTIONS	
GH = Gingival Height	α_s - Standard maximum angulation
CH = Cement Height	α_c - Captive maximum angulation
IG = Adaptor 3mm	α_{di} - Direct to implant maximum angulation
	R = Rotational / Non-Engaging
	NR = Non Rotational / Engaging

STANDARD DYNAMIC TIBASE															
	GINGIVAL HEIGHT	α_s	α_c	GINGIVAL HEIGHT	α_s	α_c	GINGIVAL HEIGHT	α_s	α_c	GINGIVAL HEIGHT	α_s	α_c	GINGIVAL HEIGHT	α_s	α_c
	0,6 mm			mm			mm			mm			mm		
R	31.323.037.01-2	45°	25°	-	-	-	-	-	-	-	-	-	-	-	-
NR	31.313.037.01-2			-	-	-	-	-	-	-	-	-	-	-	-

DYNAMIC 3TIBASE				
	GINGIVAL HEIGHT	α_s	α_c	α_s
		CH-5mm	CH- 7mm	CH- 9mm
R	31.323.037.21-2	-	-	-
NR	31.313.037.21-2	-	-	-

DYNAMIC SCANBODY (LAB/CLIN)				DIGITAL ANALOG
SCANBODY	HEIGHT mm	ADAPTOR	SCREWDRIVER ADAPTOR	DIGITAL ANALOG
52.408.110.01-2	8	50.313.037.04-2 (IG-3mm)	43.621.410.01-2 43.624.410.01-2	34.613.037.01-2
52.410.110.01-2	10			
52.412.110.01-2	12			

DYNAMIC MILLING TOOL		
DYNAMIC MILLING TOOL	SHANK	α_{di}
33.315.708.01-2	3	30°
33.415.708.01-2	4	
33.615.708.01-2	6	

SCANALOG
23.413.037.01-2

DYNAMIC SCREWS			
DYNAMIC SCREW	HIGH DYNAMIC SCREW	DYNAMIC SCREWDRIVER	SCREWDRIVER LENGTH (mm)
41.320.067.01-2	-	43.618.201.01-2	18
		43.624.201.01-2	24
		43.632.201.01-2	32

STRAIGHT SCREWS	
STRAIGHT SCREW	SCREWDRIVER TORX T6
40.320.007.01-2	43.601.107.01-2

ANALOG	LAB SCANBODY
22.613.037.01-2	30.413.004.01-2

MULTI-UNIT				
	GINGIVAL HEIGHT	GINGIVAL HEIGHT	GINGIVAL HEIGHT	GINGIVAL HEIGHT
	1 mm	2 mm	3 mm	4 mm
R	42.303.037.01-2	-	-	-

LIBRARY OPTIONS
GH = Gingival Height α_s - Standard maximum angulation
CH = Cement Height α_c - Captive maximum angulation
IG = Adaptor 3mm α_{di} - Direct to implant maximum angulation
R = Rotational / Non-Engaging
NR = Non Rotational / Engaging

STANDARD DYNAMIC TIBASE															
	GINGIVAL HEIGHT	α_s	α_c	GINGIVAL HEIGHT	α_s	α_c	GINGIVAL HEIGHT	α_s	α_c	GINGIVAL HEIGHT	α_s	α_c	GINGIVAL HEIGHT	α_s	α_c
	0,7 mm			mm			mm			mm			mm		
R	31.322.038.01-2	45°	29°	-	-	-	-	-	-	-	-	-	-	-	-
NR	31.312.038.01-2			-	-	-	-	-	-	-	-	-	-	-	-

DYNAMIC 3TIBASE				
	GINGIVAL HEIGHT	α_s	α_c	α_s
	0,7 mm	CH-5mm	CH- 7mm	CH- 9mm
R	31.322.038.21-2	30°	25°	10°
NR	31.312.038.21-2			

DYNAMIC SCANBODY (LAB/CLIN)				DIGITAL ANALOG
SCANBODY	HEIGHT mm	ADAPTOR	SCREWDRIVER ADAPTOR	DIGITAL ANALOG
52.410.103.01-2	10	50.312.038.01-2	43.621.410.01-2 43.624.410.01-2	34.612.038.01-2
52.412.103.01-2	12			

DYNAMIC MILLING TOOL		
DYNAMIC MILLING TOOL	SHANK	α_{di}
33.345.804.01-2	3	25°
33.445.804.01-2	4	
33.645.804.01-2	6	

DYNAMIC SCREWS			
DYNAMIC SCREW	HIGH DYNAMIC SCREW	DYNAMIC SCREWDRIVER	SCREWDRIVER LENGTH (mm)
41.316.081.01-2	-	43.618.201.01-2	18
		43.624.201.01-2	24
		43.632.201.01-2	32

STRAIGHT SCREWS	
STRAIGHT SCREW	SCREWDRIVER Hex. 1.25
40.316.004.02-2	43.601.104.01-2

ANALOG	LAB SCANBODY
-	30.412.001.01-2

LIBRARY OPTIONS
GH = Gingival Height α_s - Standard maximum angulation
CH = Cement Height α_c - Captive maximum angulation
IG = Adaptor 3mm α_{di} - Direct to implant maximum angulation
R = Rotational / Non-Engaging
NR = Non Rotational / Engaging

STANDARD DYNAMIC TIBASE															
	GINGIVAL HEIGHT	α_s	α_c	GINGIVAL HEIGHT	α_s	α_c	GINGIVAL HEIGHT	α_s	α_c	GINGIVAL HEIGHT	α_s	α_c	GINGIVAL HEIGHT	α_s	α_c
	0.7 mm			mm			2 mm			mm			mm		
R	31.323.039.01-2	45°	29°	-	-	-	31.323.039.03-2	25°	-	-	-	-	-	-	-
NR	31.313.039.01-2			-	-	31.313.039.03-2	-			-	-	-	-		

DYNAMIC 3TIBASE

	GINGIVAL HEIGHT	α_s	α_s	α_s
	0.7 mm	CH+5mm	CH+7mm	CH+9mm
R	31.323.039.21-2	30°	25°	10°
NR	31.313.039.21-2			

DYNAMIC SCANBODY (LAB/CLIN) DIGITAL ANALOG

SCANBODY	HEIGHT mm	ADAPTOR	SCREWDRIVER ADAPTOR	DIGITAL ANALOG
52.410.114.01-2	10	50.313.039.01-2	43.621.410.01-2 43.624.410.01-2	34.613.039.01-2
52.412.114.01-2	12			

DYNAMIC MILLING TOOL

DYNAMIC MILLING TOOL	SHANK	α_{di}
33.345.856.01-2	3	25°
33.445.856.01-2	4	
33.645.856.01-2	6	

DYNAMIC SCREWS

DYNAMIC SCREW	HIGH DYNAMIC SCREW	DYNAMIC SCREWDRIVER	SCREWDRIVER LENGTH (mm)
41.316.081.01-2	-	43.618.201.01-2	18
		43.624.201.01-2	24
		43.632.201.01-2	32

STRAIGHT SCREWS

STRAIGHT SCREW	SCREWDRIVER Hex. 1.25
40.316.004.02-2	43.601.104.01-2

ANALOG	LAB SCANBODY
-	30.413.002.01-2

MULTI-UNIT

	GINGIVAL HEIGHT	GINGIVAL HEIGHT	GINGIVAL HEIGHT	GINGIVAL HEIGHT
	1 mm	2 mm	3 mm	4 mm
R	42.303.039.01-2	-	-	-

LIBRARY OPTIONS

GH = Gingival Height α_s - Standard maximum angulation
CH = Cement Height α_c - Captive maximum angulation
IG = Adaptor 3mm α_{di} - Direct to implant maximum angulation
R = Rotational / Non-Engaging
NR = Non Rotational / Engaging

STANDARD DYNAMIC TIBASE															
	GINGIVAL HEIGHT	α_s	α_c	GINGIVAL HEIGHT	α_s	α_c	GINGIVAL HEIGHT	α_s	α_c	GINGIVAL HEIGHT	α_s	α_c	GINGIVAL HEIGHT	α_s	α_c
	0.6 mm			1.5 mm			3 mm			4 mm			5 mm		
R	31.322.040.01-2	45°	30°	31.322.040.02-2	25°	25°	31.322.040.03-2	20°	30°	31.322.040.04-2	15°	30°	31.322.040.05-2	10°	23°
NR	31.312.040.01-2			31.312.040.02-2			31.312.040.03-2			31.312.040.04-2			31.312.040.05-2		
NR (Friction-Fit)	31.312.042.01-2	-	-	-	-	-	-	-	-	-	-	-	-	-	-

DYNAMIC 3TIBASE

	GINGIVAL HEIGHT	α_s	α_s	α_s	GINGIVAL HEIGHT	α_s	α_s	α_s	GINGIVAL HEIGHT	α_s	α_s	α_s	GINGIVAL HEIGHT	α_s	α_s	α_s
	0.6 mm	CH+5mm	CH+7mm	CH+9mm	1 mm	CH+5mm	CH+7mm	CH+9mm	2 mm	CH+5mm	CH+7mm	CH+9mm	3 mm	CH+5mm	CH+7mm	CH+9mm
R	31.322.040.21-2	25°	20°	10°	31.322.040.29-2	30°	25°	20°		25°	20°	15°	31.322.040.23-2	25°	20°	15°
NR	31.312.040.21-2				31.312.040.29-2				31.312.040.28-2				31.312.040.23-2			

DYNAMIC SCANBODY (LAB/CLIN) DIGITAL ANALOG DYNAMIC MILLING TOOL SCANALOG SCANBODY OP

SCANBODY	HEIGHT mm	ADAPTOR	SCREWDRIVER ADAPTOR	DIGITAL ANALOG	DYNAMIC MILLING TOOL	SHANK	α_{di}	SCANALOG	SCANBODY	PEEK PINS	mm
52.408.101.01-2	8	50.312.040.03-2 (IG-3mm)	43.621.410.01-2 43.624.410.01-2	34.612.040.01-2	33.370.716.01-2	3	25°	23.412.040.01-2	54.315.040.21-2	49.414.000.01-2	6
52.410.101.01-2	10				33.470.716.01-2	4				49.415.000.01-2	9
52.412.101.01-2	12				33.670.716.01-2	6				49.416.000.01-2	13

SCREWDRIVER 43.625.105.01-2

DYNAMIC SCREWS

DYNAMIC SCREW	HIGH DYNAMIC SCREW	DYNAMIC SCREWDRIVER	SCREWDRIVER LENGTH (mm)
41.317.071.01-2	41.317.106.01-2	43.618.201.01-2	18
		43.624.201.01-2	24
		43.632.201.01-2	32

STRAIGHT SCREWS

STRAIGHT SCREW	SCREWDRIVER Hex. 1.27
40.317.004.01-2	43.601.104.01-2

ANALOG	LAB SCANBODY
22.612.040.01-2	30.412.001.01-2

MULTI-UNIT

	GINGIVAL HEIGHT	GINGIVAL HEIGHT	GINGIVAL HEIGHT
	2 mm	3 mm	4 mm
R	42.302.040.02-2	42.302.040.03-2	42.302.040.04-2

LIBRARY OPTIONS

GH = Gingival Height α_s - Standard maximum angulation
CH = Cement Height α_c - Captive maximum angulation
IG = Adaptor 3mm α_{di} - Direct to implant maximum angulation
R = Rotational / Non-Engaging
NR = Non Rotational / Engaging

STANDARD DYNAMIC TIBASE															
	GINGIVAL HEIGHT	α_s	α_c	GINGIVAL HEIGHT	α_s	α_c	GINGIVAL HEIGHT	α_s	α_c	GINGIVAL HEIGHT	α_s	α_c	GINGIVAL HEIGHT	α_s	α_c
	0.6 mm			1.5 mm			3 mm			4 mm			5 mm		
R	31.322.040.01-2	45°	30°	31.322.040.02-2	25°	25°	31.322.040.03-2	20°	30°	31.322.040.04-2	15°	30°	31.322.040.05-2	10°	23°
NR	31.312.040.01-2			31.312.040.02-2			31.312.040.03-2			31.312.040.04-2			31.312.040.05-2		
NR (Friction-Fit)	31.312.042.01-2			-			-			-			-		

DYNAMIC 3TIBASE																
	GINGIVAL HEIGHT	α_s	α_s	α_s	GINGIVAL HEIGHT	α_s	α_s	α_s	GINGIVAL HEIGHT	α_s	α_s	α_s	GINGIVAL HEIGHT	α_s	α_s	α_s
	0.6 mm	CH-5mm	CH-7mm	CH-9mm	1 mm	CH-5mm	CH-7mm	CH-9mm	2 mm	CH-5mm	CH-7mm	CH-9mm	3 mm	CH-5mm	CH-7mm	CH-9mm
R	31.322.040.21-2	25°	20°	10°	31.322.040.29-2	30°	25°	20°		25°	20°	15°	31.322.040.23-2	25°	20°	15°
NR	31.312.040.21-2				31.312.040.29-2				31.312.040.28-2				31.312.040.23-2			

DYNAMIC SCANBODY (LAB/CLIN)					DIGITAL ANALOG
SCANBODY	HEIGHT mm	ADAPTOR	SCREWDRIVER ADAPTOR	DIGITAL ANALOG	
-	-	-	-	-	
-	-	-	-	-	
-	-	-	-	-	

DYNAMIC MILLING TOOL		
DYNAMIC MILLING TOOL	SHANK	α_{di}
33.370.716.01-2	3	25°
33.470.716.01-2	4	
33.670.716.01-2	6	

DYNAMIC SCREWS			
DYNAMIC SCREW	HIGH DYNAMIC SCREW	DYNAMIC SCREWDRIVER	SCREWDRIVER LENGTH (mm)
41.318.071.01-2	-	43.618.201.01-2	18
		43.624.201.01-2	24
		43.632.201.01-2	32

STRAIGHT SCREWS	
STRAIGHT SCREW	SCREWDRIVER Hex. 1.27
-	-

ANALOG	LAB SCANBODY
-	30.412.001.01-2

LIBRARY OPTIONS

GH = Gingival Height α_s - Standard maximum angulation
CH = Cement Height α_c - Captive maximum angulation
IG = Adaptor 3mm α_{di} - Direct to implant maximum angulation
R = Rotational / Non-Engaging
NR = Non Rotational / Engaging

STANDARD DYNAMIC TIBASE															
	GINGIVAL HEIGHT	α_s	α_c	GINGIVAL HEIGHT	α_s	α_c	GINGIVAL HEIGHT	α_s	α_c	GINGIVAL HEIGHT	α_s	α_c	GINGIVAL HEIGHT	α_s	α_c
	0.4 mm			1.5 mm			mm			mm			mm		
R	31.323.041.01-2	45°	30°	31.323.041.02-2	30°	25°	-	-	-	-	-	-	-	-	-
NR	31.313.041.01-2			31.313.041.02-2			-			-					
NR (Friction-Fit)	31.313.043.01-2			-			-			-					

DYNAMIC 3TIBASE				
	GINGIVAL HEIGHT	α_s	α_s	α_s
	0.4 mm	CH-5mm	CH-7mm	CH-9mm
R	31.323.041.21-2	30°	20°	10°
NR	31.313.041.21-2			

DYNAMIC SCANBODY (LAB/CLIN)				DIGITAL ANALOG
SCANBODY	HEIGHT mm	ADAPTOR	SCREWDRIVER ADAPTOR	DIGITAL ANALOG
52.410.102.01-2	10	50.313.041.03-2 (IG-3mm)	43.621.410.01-2	34.613.041.01-2
			43.624.410.01-2	
52.412.102.01-2	12			

DYNAMIC MILLING TOOL		
DYNAMIC MILLING TOOL	SHANK	α_{di}
33.370.716.01-2	3	30°
33.470.716.01-2	4	
33.670.716.01-2	6	

SCANALOG
23.413.041.01-2

DYNAMIC SCREWS			
DYNAMIC SCREW	HIGH DYNAMIC SCREW	DYNAMIC SCREWDRIVER	SCREWDRIVER LENGTH (mm)
41.317.071.01-2	-	43.618.201.01-2	18
		43.624.201.01-2	24
		43.632.201.01-2	32

STRAIGHT SCREWS	
STRAIGHT SCREW	SCREWDRIVER Hex. 1.27
40.317.004.01-2	43.601.104.01-2

ANALOG	LAB SCANBODY
22.613.041.01-2	30.413.002.01-2

LIBRARY OPTIONS

GH = Gingival Height α_s - Standard maximum angulation
CH = Cement Height α_c - Captive maximum angulation
IG = Adaptor 3mm α_{di} - Direct to implant maximum angulation
R = Rotational / Non-Engaging
NR = Non Rotational / Engaging

STANDARD DYNAMIC TIBASE															
	GINGIVAL HEIGHT	α_s	α_c	GINGIVAL HEIGHT	α_s	α_c	GINGIVAL HEIGHT	α_s	α_c	GINGIVAL HEIGHT	α_s	α_c	GINGIVAL HEIGHT	α_s	α_c
	0.4 mm			1.5 mm			mm			mm			mm		
R	31.323.041.01-2	45°	30°	31.323.041.02-2	30°	25°	-	-	-	-	-	-	-	-	-
NR	31.313.041.01-2			31.313.041.02-2			-	-	-	-	-	-	-	-	-

DYNAMIC 3TIBASE				
	GINGIVAL HEIGHT	α_s	α_s	α_s
	0.4 mm	CH-5mm	CH-7mm	CH-9mm
R	31.323.041.21-2	30°	20°	10°
NR	31.313.041.21-2			

DYNAMIC SCANBODY (LAB/CLIN)				DIGITAL ANALOG
SCANBODY	HEIGHT mm	ADAPTOR	SCREWDRIVER ADAPTOR	DIGITAL ANALOG
-	-	-	-	-
-	-	-	-	-

DYNAMIC MILLING TOOL		
DYNAMIC MILLING TOOL	SHANK	α_{di}
33.370.716.01-2	3	30°
33.470.716.01-2	4	
33.670.716.01-2	6	

DYNAMIC SCREWS			
DYNAMIC SCREW	HIGH DYNAMIC SCREW	DYNAMIC SCREWDRIVER	SCREWDRIVER LENGTH (mm)
41.318.071.01-2	-	43.618.201.01-2	18
		43.624.201.01-2	24
		43.632.201.01-2	32

STRAIGHT SCREWS	
STRAIGHT SCREW	SCREWDRIVER Hex. 1.27
-	-

ANALOG	LAB SCANBODY
-	30.413.002.01-2

LIBRARY OPTIONS
GH = Gingival Height α_s - Standard maximum angulation
CH = Cement Height α_c - Captive maximum angulation
IG = Adaptor 3mm α_{di} - Direct to implant maximum angulation
R = Rotational / Non-Engaging
NR = Non Rotational / Engaging

STANDARD DYNAMIC TIBASE															
	GINGIVAL HEIGHT	α_s	α_c	GINGIVAL HEIGHT	α_s	α_c	GINGIVAL HEIGHT	α_s	α_c	GINGIVAL HEIGHT	α_s	α_c	GINGIVAL HEIGHT	α_s	α_c
	1 mm			mm			mm			mm			mm		
R	31.322.044.01-2	42°	23°	-	-	-	-	-	-	-	-	-	-	-	-
NR	31.312.044.01-2			-	-	-	-	-	-	-	-	-	-	-	-

DYNAMIC 3TIBASE				
	GINGIVAL HEIGHT	α_s	α_s	α_s
	1 mm	CH-5mm	CH-7mm	CH-9mm
R	31.322.044.21-2	25°	20°	10°
NR	31.312.044.21-2			

DYNAMIC SCANBODY (LAB/CLIN)				DIGITAL ANALOG
SCANBODY	HEIGHT mm	ADAPTOR	SCREWDRIVER ADAPTOR	DIGITAL ANALOG
52.410.105.01-2	10	50.312.044.01-2	43.621.410.01-2	34.612.044.01-2
			43.624.410.01-2	
52.412.105.01-2	12			

DYNAMIC MILLING TOOL		
DYNAMIC MILLING TOOL	SHANK	α_{di}
33.390.716.01-2	3	25°
33.490.716.01-2	4	
33.690.716.01-2	6	

DYNAMIC SCREWS			
DYNAMIC SCREW	HIGH DYNAMIC SCREW	DYNAMIC SCREWDRIVER	SCREWDRIVER LENGTH (mm)
41.318.065.01-2	-	43.618.201.01-2	18
		43.624.201.01-2	24
		43.632.201.01-2	32

STRAIGHT SCREWS	
STRAIGHT SCREW	SCREWDRIVER Hex. 1.20
40.318.003.01-2	43.601.103.02-2

ANALOG	LAB SCANBODY
-	30.412.001.01-2

LIBRARY OPTIONS
GH = Gingival Height α_s - Standard maximum angulation
CH = Cement Height α_c - Captive maximum angulation
IG = Adaptor 3mm α_{di} - Direct to implant maximum angulation
R = Rotational / Non-Engaging
NR = Non Rotational / Engaging

STANDARD DYNAMIC TIBASE															
	GINGIVAL HEIGHT	α_s	α_c	GINGIVAL HEIGHT	α_s	α_c	GINGIVAL HEIGHT	α_s	α_c	GINGIVAL HEIGHT	α_s	α_c	GINGIVAL HEIGHT	α_s	α_c
	1 mm			mm			mm			mm			mm		
R	31.323.045.01-2	43°	22°	-	-	-	-	-	-	-	-	-	-	-	-
NR	31.313.045.01-2			-	-	-	-	-	-	-	-	-	-	-	-

DYNAMIC 3TIBASE				
	GINGIVAL HEIGHT	α_s	α_c	α_d
	1 mm	CH-5mm	CH-7mm	CH-9mm
R	31.323.045.21-2	30°	20°	10°
NR	31.313.045.21-2			

DYNAMIC SCANBODY (LAB/CLIN)				DIGITAL ANALOG
SCANBODY	HEIGHT mm	ADAPTOR	SCREWDRIVER ADAPTOR	DIGITAL ANALOG
52.410.118.01-2	10	50.313.045.01-2	43.621.410.01-2 43.624.410.01-2	34.613.045.01-2
52.412.118.01-2	12			

DYNAMIC MILLING TOOL		
DYNAMIC MILLING TOOL	SHANK	α_{di}
33.390.716.01-2	3	30°
33.490.716.01-2	4	
33.690.716.01-2	6	

DYNAMIC SCREWS			
DYNAMIC SCREW	HIGH DYNAMIC SCREW	DYNAMIC SCREWDRIVER	SCREWDRIVER LENGTH (mm)
41.318.065.01-2	-	43.618.201.01-2	18
		43.624.201.01-2	24
		43.632.201.01-2	32

STRAIGHT SCREWS	
STRAIGHT SCREW	SCREWDRIVER Hex. 1.20
40.318.003.01-2	43.601.103.02-2

ANALOG	LAB SCANBODY
-	30.413.002.01-2

LIBRARY OPTIONS

GH = Gingival Height α_s - Standard maximum angulation
CH = Cement Height α_c - Captive maximum angulation
IG = Adaptor 3mm α_d - Direct to implant maximum angulation
R = Rotational / Non-Engaging
NR = Non Rotational / Engaging

STANDARD DYNAMIC TIBASE															
	GINGIVAL HEIGHT	α_s	α_c	GINGIVAL HEIGHT	α_s	α_c	GINGIVAL HEIGHT	α_s	α_c	GINGIVAL HEIGHT	α_s	α_c	GINGIVAL HEIGHT	α_s	α_c
	1 mm			mm			mm			mm			mm		
R	31.324.046.01-2	42°	21°	-	-	-	-	-	-	-	-	-	-	-	-
NR	31.314.046.01-2			-	-	-	-	-	-	-	-	-	-	-	-

DYNAMIC 3TIBASE				
	GINGIVAL HEIGHT	α_s	α_c	α_d
	1 mm	CH-5mm	CH-7mm	CH-9mm
R	31.324.046.21-2	30°	20°	10°
NR	-			

DYNAMIC SCANBODY (LAB/CLIN)				DIGITAL ANALOG
SCANBODY	HEIGHT mm	ADAPTOR	SCREWDRIVER ADAPTOR	DIGITAL ANALOG
52.410.125.01-2	10	50.314.046.01-2	43.621.410.01-2 43.624.410.01-2	34.614.046.01-2
52.412.125.01-2	12			

DYNAMIC MILLING TOOL		
DYNAMIC MILLING TOOL	SHANK	α_{di}
33.390.716.01-2	3	30°
33.490.716.01-2	4	
33.690.716.01-2	6	

DYNAMIC SCREWS			
DYNAMIC SCREW	HIGH DYNAMIC SCREW	DYNAMIC SCREWDRIVER	SCREWDRIVER LENGTH (mm)
41.318.065.01-2	-	43.618.201.01-2	18
		43.624.201.01-2	24
		43.632.201.01-2	32

STRAIGHT SCREWS	
STRAIGHT SCREW	SCREWDRIVER Hex. 1.20
40.318.003.01-2	43.601.103.02-2

ANALOG	LAB SCANBODY
-	30.413.002.01-2

LIBRARY OPTIONS

GH = Gingival Height α_s - Standard maximum angulation
CH = Cement Height α_c - Captive maximum angulation
IG = Adaptor 3mm α_d - Direct to implant maximum angulation
R = Rotational / Non-Engaging
NR = Non Rotational / Engaging

STANDARD DYNAMIC TIBASE															
	GINGIVAL HEIGHT	α_s	α_c	GINGIVAL HEIGHT	α_s	α_c	GINGIVAL HEIGHT	α_s	α_c	GINGIVAL HEIGHT	α_s	α_c	GINGIVAL HEIGHT	α_s	α_c
	0,6 mm			mm			mm			mm			mm		
R	31.322.047.01-2	45°	30°	-	-	-	-	-	-	-	-	-	-	-	-
NR	31.312.047.01-2			-	-	-	-	-	-	-	-	-	-	-	-

DYNAMIC 3TIBASE				
	GINGIVAL HEIGHT	α_s	α_c	α_s
	0,6 mm	CH-5mm	CH- 7mm	CH- 9mm
R	-	30°	25°	20°
NR	31.312.047.21-2			

DYNAMIC SCANBODY (LAB/CLIN)				DIGITAL ANALOG
SCANBODY	HEIGHT mm	ADAPTOR	SCREWDRIVER ADAPTOR	DIGITAL ANALOG
52.409.123.01-2	9	50.312.047.01-2	43.621.410.01-2 43.624.410.01-2	34.612.047.01-2
52.410.123.01-2	10			
52.412.123.01-2	12			

DYNAMIC MILLING TOOL		
DYNAMIC MILLING TOOL	SHANK	α_{di}
33.390.716.01-2	3	25°
33.490.716.01-2	4	
33.690.716.01-2	6	

DYNAMIC SCREWS			
DYNAMIC SCREW	HIGH DYNAMIC SCREW	DYNAMIC SCREWDRIVER	SCREWDRIVER LENGTH (mm)
41.320.074.01-2	-	43.618.201.01-2	18
		43.624.201.01-2	24
		43.632.201.01-2	32

STRAIGHT SCREWS	
STRAIGHT SCREW	SCREWDRIVER TORX T6
40.320.007.02-2	43.601.107.01-2

ANALOG	LAB SCANBODY
-	30.412.001.01-2

LIBRARY OPTIONS
GH = Gingival Height α_s - Standard maximum angulation
CH = Cement Height α_c - Captive maximum angulation
IG = Adaptor 3mm α_s - Direct to implant maximum angulation
R = Rotational / Non-Engaging
NR = Non Rotational / Engaging

STANDARD DYNAMIC TIBASE															
	GINGIVAL HEIGHT	α_s	α_c	GINGIVAL HEIGHT	α_s	α_c	GINGIVAL HEIGHT	α_s	α_c	GINGIVAL HEIGHT	α_s	α_c	GINGIVAL HEIGHT	α_s	α_c
	0,6 mm			mm			mm			mm			mm		
R	31.323.048.01-2	45°	30°	-	-	-	-	-	-	-	-	-	-	-	-
NR	31.313.048.01-2			-	-	-	-	-	-	-	-	-	-	-	-

DYNAMIC 3TIBASE				
	GINGIVAL HEIGHT	α_s	α_c	α_s
	0,6 mm	CH-5mm	CH- 7mm	CH- 9mm
R	31.323.048.21-2	30°	25°	20°
NR	31.313.048.21-2			

DYNAMIC SCANBODY (LAB/CLIN)				DIGITAL ANALOG
SCANBODY	HEIGHT mm	ADAPTOR	SCREWDRIVER ADAPTOR	DIGITAL ANALOG
52.409.123.01-2	9	50.312.047.01-2	43.621.410.01-2 43.624.410.01-2	34.612.047.01-2
52.410.123.01-2	10			
52.412.123.01-2	12			

DYNAMIC MILLING TOOL		
DYNAMIC MILLING TOOL	SHANK	α_{di}
33.390.716.01-2	3	30°
33.490.716.01-2	4	
33.690.716.01-2	6	

DYNAMIC SCREWS			
DYNAMIC SCREW	HIGH DYNAMIC SCREW	DYNAMIC SCREWDRIVER	SCREWDRIVER LENGTH (mm)
41.320.074.01-2	-	43.618.201.01-2	18
		43.624.201.01-2	24
		43.632.201.01-2	32

STRAIGHT SCREWS	
STRAIGHT SCREW	SCREWDRIVER TORX T6
40.320.007.02-2	43.601.107.01-2

ANALOG	LAB SCANBODY
-	30.413.002.01-2

LIBRARY OPTIONS
GH = Gingival Height α_s - Standard maximum angulation
CH = Cement Height α_c - Captive maximum angulation
IG = Adaptor 3mm α_s - Direct to implant maximum angulation
R = Rotational / Non-Engaging
NR = Non Rotational / Engaging

STANDARD DYNAMIC TIBASE															
	GINGIVAL HEIGHT	α_s	α_c	GINGIVAL HEIGHT	α_s	α_c	GINGIVAL HEIGHT	α_s	α_c	GINGIVAL HEIGHT	α_s	α_c	GINGIVAL HEIGHT	α_s	α_c
	0.6 mm			mm			mm			mm			mm		
R	31.321.049.01-2	45°	30°	-	-	-	-	-	-	-	-	-	-	-	-
NR	31.311.049.01-2			-	-	-	-	-	-	-	-	-	-	-	-

DYNAMIC 3TIBASE				
	GINGIVAL HEIGHT	α_s	α_c	α_d
		CH-5mm	CH-7mm	CH-9mm
R	-	-	-	-
NR	-	-	-	-

DYNAMIC SCANBODY (LAB/CLIN)				DIGITAL ANALOG
SCANBODY	HEIGHT mm	ADAPTOR	SCREWDRIVER ADAPTOR	DIGITAL ANALOG
52.410.116.01-2	10	50.311.049.01-2	43.621.410.01-2 43.624.410.01-2	34.611.049.01-2
52.412.116.01-2	12			

DYNAMIC MILLING TOOL		
DYNAMIC MILLING TOOL	SHANK	α_{di}
33.325.472.01-2*	3	25°
33.425.472.01-2*	4	
33.625.472.01-2*	6	

* Only for titanium and soft materials

DYNAMIC SCREWS			
DYNAMIC SCREW	HIGH DYNAMIC SCREW	DYNAMIC SCREWDRIVER	SCREWDRIVER LENGTH (mm)
41.314.064.01-2	-	43.618.201.01-2	18
		43.624.201.01-2	24
		43.632.201.01-2	32

STRAIGHT SCREWS	
STRAIGHT SCREW	SCREWDRIVER Hex. 1.25
40.314.004.01-2	43.601.104.01-2

ANALOG	LAB SCANBODY
-	30.412.001.01-2

LIBRARY OPTIONS

- GH** = Gingival Height α_s - Standard maximum angulation
- CH** = Cement Height α_c - Captive maximum angulation
- IG** = Adaptor 3mm α_d - Direct to implant maximum angulation
- R** = Rotational / Non-Engaging
- NR** = Non Rotational / Engaging

STANDARD DYNAMIC TIBASE															
	GINGIVAL HEIGHT	α_s	α_c	GINGIVAL HEIGHT	α_s	α_c	GINGIVAL HEIGHT	α_s	α_c	GINGIVAL HEIGHT	α_s	α_c	GINGIVAL HEIGHT	α_s	α_c
	0.5 mm			mm			2 mm			mm			mm		
R	31.323.051.01-2	45°	27°	-	-	-	31.323.051.03-2	25°	-	-	-	-	-	-	-
NR	31.313.051.01-2			-	-	-	31.313.051.03-2			-	-	-	-	-	-

DYNAMIC 3TIBASE				
	GINGIVAL HEIGHT	α_s	α_c	α_d
		CH-5mm	CH-7mm	CH-9mm
R	-	-	-	-
NR	-	-	-	-

DYNAMIC SCANBODY (LAB/CLIN)				DIGITAL ANALOG
SCANBODY	HEIGHT mm	ADAPTOR	SCREWDRIVER ADAPTOR	DIGITAL ANALOG
52.410.117.01-2	10	50.312.050.04-2 (IG-3mm)	43.621.410.01-2 43.624.410.01-2	34.612.050.01-2
52.412.117.01-2	12			

DYNAMIC MILLING TOOL		
DYNAMIC MILLING TOOL	SHANK	α_{di}
33.335.676.01-2	3	25°
33.435.676.01-2	4	
33.635.676.01-2	6	

DYNAMIC SCREWS			
DYNAMIC SCREW	HIGH DYNAMIC SCREW	DYNAMIC SCREWDRIVER	SCREWDRIVER LENGTH (mm)
41.318.064.01-2	-	43.618.201.01-2	18
		43.624.201.01-2	24
		43.632.201.01-2	32

STRAIGHT SCREWS	
STRAIGHT SCREW	SCREWDRIVER Hex. 1.25
40.318.004.03-2	43.601.104.01-2

ANALOG	LAB SCANBODY
-	30.412.001.01-2

LIBRARY OPTIONS

- GH** = Gingival Height α_s - Standard maximum angulation
- CH** = Cement Height α_c - Captive maximum angulation
- IG** = Adaptor 3mm α_d - Direct to implant maximum angulation
- R** = Rotational / Non-Engaging
- NR** = Non Rotational / Engaging

STANDARD DYNAMIC TIBASE															
	GINGIVAL HEIGHT	α_s	α_c	GINGIVAL HEIGHT	α_s	α_c	GINGIVAL HEIGHT	α_s	α_c	GINGIVAL HEIGHT	α_s	α_c	GINGIVAL HEIGHT	α_s	α_c
	0.5 mm			mm			2 mm			mm			mm		
R	31.323.051.01-2	45°	25°	-	-	-	31.323.051.03-2	25°	-	-	-	-	-	-	-
NR	31.313.051.01-2			-	-	-	31.313.051.03-2	-	-	-	-	-	-	-	-

DYNAMIC 3TIBASE				
	GINGIVAL HEIGHT	α_s	α_c	α_s
		CH+5mm	CH+ 7mm	CH+ 9mm
R	-	-	-	-
NR	-	-	-	-

DYNAMIC SCANBODY (LAB/CLIN)				DIGITAL ANALOG
SCANBODY	HEIGHT mm	ADAPTOR	SCREWDRIVER ADAPTOR	DIGITAL ANALOG
52.410.118.01-2	10	50.313.051.01-2 50.313.051.04-2 (IG-3mm)	43.621.410.01-2 43.624.410.01-2	34.613.051.01-2
52.412.118.01-2	12			

DYNAMIC MILLING TOOL		
DYNAMIC MILLING TOOL	SHANK	α_{di}
33.335.676.01-2	3	25°
33.435.676.01-2	4	
33.635.676.01-2	6	

DYNAMIC SCREWS			
DYNAMIC SCREW	HIGH DYNAMIC SCREW	DYNAMIC SCREWDRIVER	SCREWDRIVER LENGTH (mm)
41.318.064.01-2	-	43.618.201.01-2	18
		43.624.201.01-2	24
		43.632.201.01-2	32

STRAIGHT SCREWS	
STRAIGHT SCREW	SCREWDRIVER Hex. 1.25
40.318.004.03-2	43.601.104.01-2

ANALOG	LAB SCANBODY
-	30.412.001.01-2

LIBRARY OPTIONS

GH = Gingival Height α_s - Standard maximum angulation
CH = Cement Height α_c - Captive maximum angulation
IG = Adaptor 3mm α_{di} - Direct to implant maximum angulation
R = Rotational / Non-Engaging
NR = Non Rotational / Engaging

STANDARD DYNAMIC TIBASE															
	GINGIVAL HEIGHT	α_s	α_c	GINGIVAL HEIGHT	α_s	α_c	GINGIVAL HEIGHT	α_s	α_c	GINGIVAL HEIGHT	α_s	α_c	GINGIVAL HEIGHT	α_s	α_c
	0.3 mm			mm			mm			mm			mm		
R	31.324.052.01-2	45°	27°	-	-	-	-	-	-	-	-	-	-	-	-
NR	31.314.052.01-2			-	-	-	-	-	-	-	-	-	-	-	-

DYNAMIC 3TIBASE				
	GINGIVAL HEIGHT	α_s	α_c	α_s
		CH+5mm	CH+ 7mm	CH+ 9mm
R	-	-	-	-
NR	-	-	-	-

DYNAMIC SCANBODY (LAB/CLIN)				DIGITAL ANALOG
SCANBODY	HEIGHT mm	ADAPTOR	SCREWDRIVER ADAPTOR	DIGITAL ANALOG
52.410.102.01-2	10	50.314.052.04-2 (IG-3mm)	43.621.410.01-2 43.624.410.01-2	34.614.052.01-2
52.412.102.01-2	12			

DYNAMIC MILLING TOOL		
DYNAMIC MILLING TOOL	SHANK	α_{di}
33.335.676.01-2	3	30°
33.435.676.01-2	4	
33.635.676.01-2	6	

DYNAMIC SCREWS			
DYNAMIC SCREW	HIGH DYNAMIC SCREW	DYNAMIC SCREWDRIVER	SCREWDRIVER LENGTH (mm)
41.318.064.01-2	-	43.618.201.01-2	18
		43.624.201.01-2	24
		43.632.201.01-2	32

STRAIGHT SCREWS	
STRAIGHT SCREW	SCREWDRIVER Hex. 1.25
40.318.004.03-2	43.601.104.01-2

ANALOG	LAB SCANBODY
-	30.413.002.01-2

LIBRARY OPTIONS

GH = Gingival Height α_s - Standard maximum angulation
CH = Cement Height α_c - Captive maximum angulation
IG = Adaptor 3mm α_{di} - Direct to implant maximum angulation
R = Rotational / Non-Engaging
NR = Non Rotational / Engaging

STANDARD DYNAMIC TIBASE															
	GINGIVAL HEIGHT	α_s	α_c	GINGIVAL HEIGHT	α_s	α_c	GINGIVAL HEIGHT	α_s	α_c	GINGIVAL HEIGHT	α_s	α_c	GINGIVAL HEIGHT	α_s	α_c
	0,6 mm			mm			mm			mm			mm		
R	31.323.054.01-2	45°	25°	-	-	-	-	-	-	-	-	-	-	-	-
NR	31.313.054.01-2			-	-	-	-	-	-	-	-	-	-	-	-

DYNAMIC 3TIBASE				
	GINGIVAL HEIGHT	α_s	α_c	α_s
		CH+5mm	CH+7mm	CH+9mm
R	-	-	-	-
NR	-	-	-	-

DYNAMIC SCANBODY (LAB/CLIN)				DIGITAL ANALOG
SCANBODY	HEIGHT mm	ADAPTOR	SCREWDRIVER ADAPTOR	DIGITAL ANALOG
52.410.119.01-2	10	50.314.054.01-2	43.621.410.01-2 43.624.410.01-2	34.614.054.01-2
52.412.119.01-2	12			

DYNAMIC MILLING TOOL		
DYNAMIC MILLING TOOL	SHANK	α_{di}
33.345.856.01-2	3	30°
33.445.856.01-2	4	
33.645.856.01-2	6	

DYNAMIC SCREWS			
DYNAMIC SCREW	HIGH DYNAMIC SCREW	DYNAMIC SCREWDRIVER	SCREWDRIVER LENGTH (mm)
41.318.067.01-2	-	43.618.201.01-2	18
		43.624.201.01-2	24
		43.632.201.01-2	32

STRAIGHT SCREWS	
STRAIGHT SCREW	SCREWDRIVER -
40.318.012.01-2	-

ANALOG	LAB SCANBODY
-	30.413.002.01-2

LIBRARY OPTIONS
GH = Gingival Height α_s - Standard maximum angulation
CH = Cement Height α_c - Captive maximum angulation
IG = Adaptor 3mm α_s - Direct to implant maximum angulation
R = Rotational / Non-Engaging
NR = Non Rotational / Engaging

STANDARD DYNAMIC TIBASE															
	GINGIVAL HEIGHT	α_s	α_c	GINGIVAL HEIGHT	α_s	α_c	GINGIVAL HEIGHT	α_s	α_c	GINGIVAL HEIGHT	α_s	α_c	GINGIVAL HEIGHT	α_s	α_c
	0,5 mm			mm			mm			mm			mm		
R	31.324.057.01-2	45°	27°	-	-	-	-	-	-	-	-	-	-	-	-
NR	31.314.057.01-2			-	-	-	-	-	-	-	-	-	-	-	-

DYNAMIC 3TIBASE				
	GINGIVAL HEIGHT	α_s	α_c	α_s
		CH+5mm	CH+7mm	CH+9mm
R	-	-	-	-
NR	-	-	-	-

DYNAMIC SCANBODY (LAB/CLIN)				DIGITAL ANALOG
SCANBODY	HEIGHT mm	ADAPTOR	SCREWDRIVER ADAPTOR	DIGITAL ANALOG
52.408.101.01-2	8	50.314.057.01-2	43.621.410.01-2 43.624.410.01-2	34.614.057.01-2
52.410.101.01-2	10			
52.412.101.01-2	12			

DYNAMIC MILLING TOOL		
DYNAMIC MILLING TOOL	SHANK	α_{di}
33.390.805.01-2	3	30°
33.490.805.01-2	4	
33.690.805.01-2	6	

DYNAMIC SCREWS			
DYNAMIC SCREW	HIGH DYNAMIC SCREW	DYNAMIC SCREWDRIVER	SCREWDRIVER LENGTH (mm)
41.316.084.01-2	-	43.618.201.01-2	18
		43.624.201.01-2	24
		43.632.201.01-2	32

STRAIGHT SCREWS	
STRAIGHT SCREW	SCREWDRIVER Hex. 1.20
40.316.003.01-2	43.601.103.02-2

ANALOG	LAB SCANBODY
22.614.057.01-2	30.414.003.01-2

LIBRARY OPTIONS
GH = Gingival Height α_s - Standard maximum angulation
CH = Cement Height α_c - Captive maximum angulation
IG = Adaptor 3mm α_s - Direct to implant maximum angulation
R = Rotational / Non-Engaging
NR = Non Rotational / Engaging

STANDARD DYNAMIC TIBASE															
	GINGIVAL HEIGHT	α_s	α_c	GINGIVAL HEIGHT	α_s	α_c	GINGIVAL HEIGHT	α_s	α_c	GINGIVAL HEIGHT	α_s	α_c	GINGIVAL HEIGHT	α_s	α_c
	0.5 mm			mm			mm			mm			mm		
R	31.324.058.01-2	45°	30°	-	-	-	-	-	-	-	-	-	-	-	-
NR	31.314.058.01-2			-	-	-	-	-	-	-	-	-	-	-	-

DYNAMIC 3TIBASE				
	GINGIVAL HEIGHT	α_s	α_c	α_s
		CH-5mm	CH-7mm	CH-9mm
R	-	-	-	-
NR	-	-	-	-

DYNAMIC SCANBODY (LAB/CLIN)				DIGITAL ANALOG
SCANBODY	HEIGHT mm	ADAPTOR	SCREWDRIVER ADAPTOR	DIGITAL ANALOG
52.410.118.01-2	10	50.314.058.01-2	43.621.410.01-2 43.624.410.01-2	34.614.058.01-2
52.412.118.01-2	12			

DYNAMIC MILLING TOOL		
DYNAMIC MILLING TOOL	SHANK	α_{di}
33.390.716.01-2	3	30°
33.490.716.01-2	4	
33.690.716.01-2	6	

DYNAMIC SCREWS			
DYNAMIC SCREW	HIGH DYNAMIC SCREW	DYNAMIC SCREWDRIVER	SCREWDRIVER LENGTH (mm)
41.320.047.01-2	-	43.618.201.01-2	18
		43.624.201.01-2	24
		43.632.201.01-2	32

STRAIGHT SCREWS	
STRAIGHT SCREW	SCREWDRIVER Hex. 1.20
40.320.003.01-2	43.601.103.02-2

ANALOG	LAB SCANBODY
22.614.058.01-2	30.414.003.01-2

LIBRARY OPTIONS

GH = Gingival Height α_s - Standard maximum angulation
CH = Cement Height α_c - Captive maximum angulation
IG = Adaptor 3mm α_s - Direct to implant maximum angulation
R = Rotational / Non-Engaging
NR = Non Rotational / Engaging

STANDARD DYNAMIC TIBASE															
	GINGIVAL HEIGHT	α_s	α_c	GINGIVAL HEIGHT	α_s	α_c	GINGIVAL HEIGHT	α_s	α_c	GINGIVAL HEIGHT	α_s	α_c	GINGIVAL HEIGHT	α_s	α_c
	0.7 mm			mm			mm			mm			mm		
R	31.324.059.01-2	45°	27°	-	-	-	-	-	-	-	-	-	-	-	-
NR	31.314.059.01-2			-	-	-	-	-	-	-	-	-	-	-	-

DYNAMIC 3TIBASE				
	GINGIVAL HEIGHT	α_s	α_c	α_s
		CH-5mm	CH-7mm	CH-9mm
R	-	-	-	-
NR	-	-	-	-

DYNAMIC SCANBODY (LAB/CLIN)				DIGITAL ANALOG
SCANBODY	HEIGHT mm	ADAPTOR	SCREWDRIVER ADAPTOR	DIGITAL ANALOG
52.410.115.01-2	10	50.313.010.01-2	43.621.410.01-2 43.624.410.01-2	-
52.412.115.01-2	12			

DYNAMIC MILLING TOOL		
DYNAMIC MILLING TOOL	SHANK	α_{di}
33.390.716.01-2	3	25
33.490.716.01-2	4	
33.690.716.01-2	6	

DYNAMIC SCREWS			
DYNAMIC SCREW	HIGH DYNAMIC SCREW	DYNAMIC SCREWDRIVER	SCREWDRIVER LENGTH (mm)
41.318.065.01-2	-	43.618.201.01-2	18
		43.624.201.01-2	24
		43.632.201.01-2	32

STRAIGHT SCREWS	
STRAIGHT SCREW	SCREWDRIVER Hex. 1.20
40.318.003.01-2	43.601.103.02-2

ANALOG	LAB SCANBODY
-	30.414.003.01-2

LIBRARY OPTIONS

GH = Gingival Height α_s - Standard maximum angulation
CH = Cement Height α_c - Captive maximum angulation
IG = Adaptor 3mm α_s - Direct to implant maximum angulation
R = Rotational / Non-Engaging
NR = Non Rotational / Engaging

STANDARD DYNAMIC TIBASE															
	GINGIVAL HEIGHT	α_s	α_c	GINGIVAL HEIGHT	α_s	α_c	GINGIVAL HEIGHT	α_s	α_c	GINGIVAL HEIGHT	α_s	α_c	GINGIVAL HEIGHT	α_s	α_c
	0.5 mm			mm			mm			mm			mm		
R	31.324.060.01-2	45°	30°	-	-	-	-	-	-	-	-	-	-	-	-
NR	31.314.060.01-2			-	-	-	-	-	-	-	-	-	-	-	-

DYNAMIC 3TIBASE				
	GINGIVAL HEIGHT	α_s	α_c	α_d
	CH-5mm	CH-7mm	CH-9mm	
R	-	-	-	-
NR	-	-	-	-

DYNAMIC SCANBODY (LAB/CLIN)				DIGITAL ANALOG
SCANBODY	HEIGHT mm	ADAPTOR	SCREWDRIVER ADAPTOR	DIGITAL ANALOG
52.410.122.01-2	10	50.314.060.01-2	43.621.410.01-2 43.624.410.01-2	34.614.060.01-2
-	-			
-	-			

DYNAMIC MILLING TOOL		
DYNAMIC MILLING TOOL	SHANK	α_{di}
33.390.716.01-2	3	30°
33.490.716.01-2	4	
33.690.716.01-2	6	

DYNAMIC SCREWS			
DYNAMIC SCREW	HIGH DYNAMIC SCREW	DYNAMIC SCREWDRIVER	SCREWDRIVER LENGTH (mm)
41.320.060.01-2	-	43.618.201.01-2	18
		43.624.201.01-2	24
		43.632.201.01-2	32

STRAIGHT SCREWS	
STRAIGHT SCREW	SCREWDRIVER Hex. 1.20
40.320.003.02-2	43.601.103.02-2

ANALOG	LAB SCANBODY
22.614.060.01-2	30.415.007.01-2

LIBRARY OPTIONS

GH = Gingival Height α_s - Standard maximum angulation
CH = Cement Height α_c - Captive maximum angulation
IG = Adaptor 3mm α_d - Direct to implant maximum angulation
R = Rotational / Non-Engaging
NR = Non Rotational / Engaging

STANDARD DYNAMIC TIBASE															
	GINGIVAL HEIGHT	α_s	α_c	GINGIVAL HEIGHT	α_s	α_c	GINGIVAL HEIGHT	α_s	α_c	GINGIVAL HEIGHT	α_s	α_c	GINGIVAL HEIGHT	α_s	α_c
	0.6 mm			mm			mm			mm			mm		
R	31.324.061.01-2	45°	30°	-	-	-	-	-	-	-	-	-	-	-	-
NR	31.314.061.01-2			-	-	-	-	-	-	-	-	-	-	-	-

DYNAMIC 3TIBASE				
	GINGIVAL HEIGHT	α_s	α_c	α_d
	CH-5mm	CH-7mm	CH-9mm	
R	-	-	-	-
NR	-	-	-	-

DYNAMIC SCANBODY (LAB/CLIN)				DIGITAL ANALOG
SCANBODY	HEIGHT mm	ADAPTOR	SCREWDRIVER ADAPTOR	DIGITAL ANALOG
52.410.125.01-2	10	50.314.061.01-2	43.621.410.01-2 43.624.410.01-2	34.614.061.01-2
-	-			
-	-			

DYNAMIC MILLING TOOL		
DYNAMIC MILLING TOOL	SHANK	α_{di}
33.390.958.01-2	3	30°
33.490.958.01-2	4	
33.690.958.01-2	6	

DYNAMIC SCREWS			
DYNAMIC SCREW	HIGH DYNAMIC SCREW	DYNAMIC SCREWDRIVER	SCREWDRIVER LENGTH (mm)
41.325.067.01-2	-	43.618.201.01-2	18
		43.624.201.01-2	24
		43.632.201.01-2	32

STRAIGHT SCREWS	
STRAIGHT SCREW	SCREWDRIVER UNIGRIP
40.325.008.01-2	43.601.108.01-2

ANALOG	LAB SCANBODY
22.614.061.01-2	30.415.007.01-2

LIBRARY OPTIONS

GH = Gingival Height α_s - Standard maximum angulation
CH = Cement Height α_c - Captive maximum angulation
IG = Adaptor 3mm α_d - Direct to implant maximum angulation
R = Rotational / Non-Engaging
NR = Non Rotational / Engaging

STANDARD DYNAMIC TIBASE															
	GINGIVAL HEIGHT	α_s	α_c	GINGIVAL HEIGHT	α_s	α_c	GINGIVAL HEIGHT	α_s	α_c	GINGIVAL HEIGHT	α_s	α_c	GINGIVAL HEIGHT	α_s	α_c
	0,6 mm			mm			mm			mm			mm		
R	31.323.066.01-2	45°	30°	-	-	-	-	-	-	-	-	-	-	-	-
NR	-			-	-	-	-	-	-	-	-	-	-	-	-

DYNAMIC 3TIBASE				
	GINGIVAL HEIGHT	α_s	α_s	α_s
		CH+ 5mm	CH+ 7mm	CH+ 9mm
R	-	-	-	-
NR	-	-	-	-

DYNAMIC SCANBODY (LAB/CLIN)				DIGITAL ANALOG
SCANBODY	HEIGHT mm	ADAPTOR	SCREWDRIVER ADAPTOR	DIGITAL ANALOG
-	-	-	-	-
-	-	-	-	-
-	-	-	-	-

DYNAMIC MILLING TOOL		
DYNAMIC MILLING TOOL	SHANK	α_{di}
-	-	-
-	-	-
-	-	-

DYNAMIC SCREWS			
DYNAMIC SCREW	HIGH DYNAMIC SCREW	DYNAMIC SCREWDRIVER	SCREWDRIVER LENGTH (mm)
41.314.039.01-2	-	43.618.201.01-2	18
		43.624.201.01-2	24
		43.632.201.01-2	32

STRAIGHT SCREWS	
STRAIGHT SCREW	SCREWDRIVER Unigrip
40.314.008.01-2	43.601.108.01-2

ANALOG	LAB SCANBODY
-	30.412.001.01-2

LIBRARY OPTIONS
GH = Gingival Height α_s - Standard maximum angulation
CH = Cement Height α_c - Captive maximum angulation
IG = Adaptor 3mm α_{di} - Direct to implant maximum angulation
R = Rotational / Non-Engaging
NR = Non Rotational / Engaging

STANDARD DYNAMIC TIBASE															
	GINGIVAL HEIGHT	α_s	α_c	GINGIVAL HEIGHT	α_s	α_c	GINGIVAL HEIGHT	α_s	α_c	GINGIVAL HEIGHT	α_s	α_c	GINGIVAL HEIGHT	α_s	α_c
	0,6 mm			mm			mm			mm			mm		
R	31.323.074.01-2	45°	30°	-	-	-	-	-	-	-	-	-	-	-	-
NR	31.313.074.01-2			-	-	-	-	-	-	-	-	-	-	-	-

DYNAMIC 3TIBASE				
	GINGIVAL HEIGHT	α_s	α_s	α_s
		CH+ 5mm	CH+ 7mm	CH+ 9mm
R	-	-	-	-
NR	-	-	-	-

DYNAMIC SCANBODY (LAB/CLIN)				DIGITAL ANALOG
SCANBODY	HEIGHT mm	ADAPTOR	SCREWDRIVER ADAPTOR	DIGITAL ANALOG
52.408.110.01-2	8	50.313.074.01-2	43.621.410.01-2 43.624.410.01-2	34.613.074.01-2
52.410.110.01-2	10			
52.412.110.01-2	12			

DYNAMIC MILLING TOOL		
DYNAMIC MILLING TOOL	SHANK	α_{di}
33.330.708.01-2	3	30°
33.430.708.01-2	4	
33.630.708.01-2	6	

SCANALOG
23.413.074.01-2

DYNAMIC SCREWS			
DYNAMIC SCREW	HIGH DYNAMIC SCREW	DYNAMIC SCREWDRIVER	SCREWDRIVER LENGTH (mm)
41.320.050.01-2	-	43.618.201.01-2	18
		43.624.201.01-2	24
		43.632.201.01-2	32

STRAIGHT SCREWS	
STRAIGHT SCREW	SCREWDRIVER Sq. 1.30
40.320.007.04-2	43.601.102.01-2

ANALOG	LAB SCANBODY
22.613.074.01-2	30.415.007.01-2

LIBRARY OPTIONS
GH = Gingival Height α_s - Standard maximum angulation
CH = Cement Height α_c - Captive maximum angulation
IG = Adaptor 3mm α_{di} - Direct to implant maximum angulation
R = Rotational / Non-Engaging
NR = Non Rotational / Engaging

STANDARD DYNAMIC TIBASE															
	GINGIVAL HEIGHT	α_s	α_c	GINGIVAL HEIGHT	α_s	α_c	GINGIVAL HEIGHT	α_s	α_c	GINGIVAL HEIGHT	α_s	α_c	GINGIVAL HEIGHT	α_s	α_c
	1 mm			2 mm			3 mm			4 mm			mm		
R	31.322.075.01-2	42°	24°	31.322.075.02-2	25°	15°	31.322.075.03-2	20°	-	31.322.075.04-2	15°	-	-	-	-
NR	-			31.312.075.02-2			31.312.075.03-2			31.312.075.04-2			-	-	-

DYNAMIC 3TIBASE

	GINGIVAL HEIGHT	α_s	α_c	α_s
	1 mm	CH-5mm	CH= 7mm	CH- 9mm
R	31.322.075.21-2	30°	20°	15°
NR	-			

DYNAMIC SCANBODY (LAB/CLIN) DIGITAL ANALOG

SCANBODY	HEIGHT mm	ADAPTOR	SCREWDRIVER ADAPTOR	DIGITAL ANALOG
52.410.105.01-2	10	50.312.075.03-2 (IG-3mm)	43.621.410.01-2 43.624.410.01-2	34.612.075.01-2
52.412.105.01-2	12			

DYNAMIC MILLING TOOL

DYNAMIC MILLING TOOL	SHANK	α_{di}
33.330.734.01-2	3	25°
33.430.734.01-2	4	
33.630.734.01-2	6	

SCANBODY OP

SCANBODY	PEEK PINS	mm
54.315.075.21-2	49.414.000.01-2	6
	49.415.000.01-2	9
	49.416.000.01-2	13

DYNAMIC SCREWS

DYNAMIC SCREW	HIGH DYNAMIC SCREW	DYNAMIC SCREWDRIVER	SCREWDRIVER LENGTH (mm)
41.318.077.01-2	-	43.618.201.01-2	18
		43.624.201.01-2	24
		43.632.201.01-2	32

STRAIGHT SCREWS

STRAIGHT SCREW	SCREWDRIVER Hex. 1.00
40.318.013.01-2	-

ANALOG LAB SCANBODY

22.612.075.01-2	30.412.001.01-2
-----------------	-----------------

MULTI-UNIT

	GINGIVAL HEIGHT	GINGIVAL HEIGHT	GINGIVAL HEIGHT	GINGIVAL HEIGHT
	1 mm	2 mm	3 mm	4 mm
R	-	42.302.075.02-2	42.302.075.03-2	42.302.075.04-2

LIBRARY OPTIONS
GH = Gingival Height α_s - Standard maximum angulation
CH = Cement Height α_c - Captive maximum angulation
IG = Adaptor 3mm α_{di} - Direct to implant maximum angulation
R = Rotational / Non-Engaging
NR = Non Rotational / Engaging

STANDARD DYNAMIC TIBASE															
	GINGIVAL HEIGHT	α_s	α_c	GINGIVAL HEIGHT	α_s	α_c	GINGIVAL HEIGHT	α_s	α_c	GINGIVAL HEIGHT	α_s	α_c	GINGIVAL HEIGHT	α_s	α_c
	0.4 mm			mm			mm			mm			mm		
R	31.324.080.01-2	45°	30°	-	-	-	-	-	-	-	-	-	-	-	-
NR	31.314.080.01-2			-	-	-	-	-	-	-	-	-	-	-	-

DYNAMIC 3TIBASE

	GINGIVAL HEIGHT	α_s	α_c	α_s
		CH-5mm	CH- 7mm	CH- 9mm
R	-	-	-	-
NR	-	-	-	-

DYNAMIC SCANBODY (LAB/CLIN) DIGITAL ANALOG

SCANBODY	HEIGHT mm	ADAPTOR	SCREWDRIVER ADAPTOR	DIGITAL ANALOG
52.410.124.01-2	10	50.314.080.01-2	43.621.410.01-2 43.624.410.01-2	34.614.080.01-2
52.412.124.01-2	12			

DYNAMIC MILLING TOOL

DYNAMIC MILLING TOOL	SHANK	α_{di}
33.370.716.01-2	3	30°
33.470.716.01-2	4	
33.670.716.01-2	6	

DYNAMIC SCREWS

DYNAMIC SCREW	HIGH DYNAMIC SCREW	DYNAMIC SCREWDRIVER	SCREWDRIVER LENGTH (mm)
41.317.071.01-2	-	43.618.201.01-2	18
		43.624.201.01-2	24
		43.632.201.01-2	32

STRAIGHT SCREWS

STRAIGHT SCREW	SCREWDRIVER Hex. 1.27
40.317.004.01-2	43.601.104.01-2

ANALOG LAB SCANBODY

-	30.414.003.01-2
---	-----------------

LIBRARY OPTIONS
GH = Gingival Height α_s - Standard maximum angulation
CH = Cement Height α_c - Captive maximum angulation
IG = Adaptor 3mm α_{di} - Direct to implant maximum angulation
R = Rotational / Non-Engaging
NR = Non Rotational / Engaging

STANDARD DYNAMIC TIBASE															
	GINGIVAL HEIGHT	α_s	α_c	GINGIVAL HEIGHT	α_s	α_c	GINGIVAL HEIGHT	α_s	α_c	GINGIVAL HEIGHT	α_s	α_c	GINGIVAL HEIGHT	α_s	α_c
	0.4 mm			mm			mm			mm			mm		
R	31.325.081.01-2	41°	18°	-	-	-	-	-	-	-	-	-	-	-	-
NR	31.315.081.01-2			-	-	-	-	-	-	-	-	-	-	-	-

DYNAMIC 3TIBASE

	GINGIVAL HEIGHT	α_s	α_c	α_s
		CH-5mm	CH-7mm	CH-9mm
R	-	-	-	-
NR	-	-	-	-

DYNAMIC SCANBODY (LAB/CLIN) **DIGITAL ANALOG**

SCANBODY	HEIGHT mm	ADAPTOR	SCREWDRIVER ADAPTOR	DIGITAL ANALOG
52.410.126.01-2	10	50.315.081.01-2	43.621.410.01-2	34.615.081.01-2
			43.624.410.01-2	
52.412.126.01-2	12			

DYNAMIC MILLING TOOL

DYNAMIC MILLING TOOL	SHANK	α_{di}
33.335.676.01-2	3	30°
33.435.676.01-2	4	
33.635.676.01-2	6	

DYNAMIC SCREWS

DYNAMIC SCREW	HIGH DYNAMIC SCREW	DYNAMIC SCREWDRIVER	SCREWDRIVER LENGTH (mm)
41.318.064.01-2	-	43.618.201.01-2	18
		43.624.201.01-2	24
		43.632.201.01-2	32

STRAIGHT SCREWS

STRAIGHT SCREW	SCREWDRIVER Hex. 1.25
40.318.004.03-2	43.601.104.01-2

ANALOG	LAB SCANBODY
-	30.414.003.01-2

LIBRARY OPTIONS
GH = Gingival Height α_s - Standard maximum angulation
CH = Cement Height α_c - Captive maximum angulation
IG = Adaptor 3mm α_s - Direct to implant maximum angulation
R = Rotational / Non-Engaging
NR = Non Rotational / Engaging

STANDARD DYNAMIC TIBASE															
	GINGIVAL HEIGHT	α_s	α_c	GINGIVAL HEIGHT	α_s	α_c	GINGIVAL HEIGHT	α_s	α_c	GINGIVAL HEIGHT	α_s	α_c	GINGIVAL HEIGHT	α_s	α_c
	1.2 mm			mm			mm			mm			mm		
R	31.322.082.01-2	45°	25°	-	-	-	-	-	-	-	-	-	-	-	-
NR	31.312.082.01-2			-	-	-	-	-	-	-	-	-	-	-	-

DYNAMIC 3TIBASE

	GINGIVAL HEIGHT	α_s	α_c	α_s
		CH-5mm	CH-7mm	CH-9mm
R	-	-	-	-
NR	-	-	-	-

DYNAMIC SCANBODY (LAB/CLIN) **DIGITAL ANALOG**

SCANBODY	HEIGHT mm	ADAPTOR	SCREWDRIVER ADAPTOR	DIGITAL ANALOG
52.410.105.01-2	10	50.312.082.01-2	43.621.410.01-2	34.612.082.01-2
			43.624.410.01-2	
52.412.105.01-2	12			

DYNAMIC MILLING TOOL

DYNAMIC MILLING TOOL	SHANK	α_{di}
33.345.804.01-2	3	25°
33.445.804.01-2	4	
33.645.804.01-2	6	

DYNAMIC SCREWS

DYNAMIC SCREW	HIGH DYNAMIC SCREW	DYNAMIC SCREWDRIVER	SCREWDRIVER LENGTH (mm)
41.316.074.01-2	-	43.618.201.01-2	18
		43.624.201.01-2	24
		43.632.201.01-2	32

STRAIGHT SCREWS

STRAIGHT SCREW	SCREWDRIVER -
40.316.012.01-2	-

ANALOG	LAB SCANBODY
-	30.412.001.01-2

LIBRARY OPTIONS
GH = Gingival Height α_s - Standard maximum angulation
CH = Cement Height α_c - Captive maximum angulation
IG = Adaptor 3mm α_s - Direct to implant maximum angulation
R = Rotational / Non-Engaging
NR = Non Rotational / Engaging

STANDARD DYNAMIC TIBASE															
	GINGIVAL HEIGHT	α_s	α_c	GINGIVAL HEIGHT	α_s	α_c	GINGIVAL HEIGHT	α_s	α_c	GINGIVAL HEIGHT	α_s	α_c	GINGIVAL HEIGHT	α_s	α_c
	1.2 mm			mm			mm			mm			mm		
R	31.323.083.01-2	45°	25°	-	-	-	-	-	-	-	-	-	-	-	-
NR	31.313.083.01-2			-	-	-	-	-	-	-	-	-	-	-	-

DYNAMIC 3TIBASE				
	GINGIVAL HEIGHT	α_s	α_c	α_d
		CH-5mm	CH-7mm	CH-9mm
R	-	-	-	-
NR	-	-	-	-

DYNAMIC SCANBODY (LAB/CLIN)				DIGITAL ANALOG
SCANBODY	HEIGHT mm	ADAPTOR	SCREWDRIVER ADAPTOR	DIGITAL ANALOG
52.410.103.01-2	10	50.313.083.01-2	43.621.410.01-2	34.613.083.01-2
			43.624.410.01-2	
52.412.103.01-2	12			

DYNAMIC MILLING TOOL		
DYNAMIC MILLING TOOL	SHANK	α_{di}
33.345.856.01-2	3	30°
33.445.856.01-2	4	
33.645.856.01-2	6	

DYNAMIC SCREWS			
DYNAMIC SCREW	HIGH DYNAMIC SCREW	DYNAMIC SCREWDRIVER	SCREWDRIVER LENGTH (mm)
41.318.076.01-2	-	43.618.201.01-2	18
		43.624.201.01-2	24
		43.632.201.01-2	32

STRAIGHT SCREWS	
STRAIGHT SCREW	SCREWDRIVER
40.318.012.02-2	-

ANALOG	LAB SCANBODY
-	30.413.002.01-2

LIBRARY OPTIONS
GH = Gingival Height α_s - Standard maximum angulation
CH = Cement Height α_c - Captive maximum angulation
IG = Adaptor 3mm α_d - Direct to implant maximum angulation
R = Rotational / Non-Engaging
NR = Non Rotational / Engaging

STANDARD DYNAMIC TIBASE															
	GINGIVAL HEIGHT	α_s	α_c	GINGIVAL HEIGHT	α_s	α_c	GINGIVAL HEIGHT	α_s	α_c	GINGIVAL HEIGHT	α_s	α_c	GINGIVAL HEIGHT	α_s	α_c
	1 mm			mm			mm			mm			mm		
R	31.321.084.01-2	40°	-	-	-	-	-	-	-	-	-	-	-	-	-
NR	31.311.084.01-2			-	-	-	-	-	-	-	-	-	-	-	-

DYNAMIC 3TIBASE				
	GINGIVAL HEIGHT	α_s	α_c	α_d
		CH-5mm	CH-7mm	CH-9mm
R	-	-	-	-
NR	-	-	-	-

DYNAMIC SCANBODY (LAB/CLIN)				DIGITAL ANALOG
SCANBODY	HEIGHT mm	ADAPTOR	SCREWDRIVER ADAPTOR	DIGITAL ANALOG
-	-	-	-	-
-	-			
-	-			

DYNAMIC MILLING TOOL		
DYNAMIC MILLING TOOL	SHANK	α_{di}
-	-	-
-	-	
-	-	

DYNAMIC SCREWS			
DYNAMIC SCREW	HIGH DYNAMIC SCREW	DYNAMIC SCREWDRIVER	SCREWDRIVER LENGTH (mm)
41.314.076.01-2	-	43.618.201.01-2	18
		43.624.201.01-2	24
		43.632.201.01-2	32

STRAIGHT SCREWS	
STRAIGHT SCREW	SCREWDRIVER Star 1.50
40.314.003.03-2	43.601.103.02-2

ANALOG	LAB SCANBODY
-	30.410.006.01-2

LIBRARY OPTIONS
GH = Gingival Height α_s - Standard maximum angulation
CH = Cement Height α_c - Captive maximum angulation
IG = Adaptor 3mm α_d - Direct to implant maximum angulation
R = Rotational / Non-Engaging
NR = Non Rotational / Engaging

STANDARD DYNAMIC TIBASE															
	GINGIVAL HEIGHT	α_s	α_c	GINGIVAL HEIGHT	α_s	α_c	GINGIVAL HEIGHT	α_s	α_c	GINGIVAL HEIGHT	α_s	α_c	GINGIVAL HEIGHT	α_s	α_c
	0.3 mm			mm			mm			mm			mm		
R	31.324.085.01-2	45°	30°	-	-	-	-	-	-	-	-	-	-	-	-
NR	31.314.085.01-2			-	-	-	-	-	-	-	-	-	-	-	-

DYNAMIC 3TIBASE				
	GINGIVAL HEIGHT	α_s	α_c	α_d
	0.3 mm	CH-5mm	CH-7mm	CH-9mm
R	-	30°	25°	20°
NR	31.314.085.21-2			

DYNAMIC SCANBODY (LAB/CLIN)				DIGITAL ANALOG
SCANBODY	HEIGHT mm	ADAPTOR	SCREWDRIVER ADAPTOR	DIGITAL ANALOG
52.410.117.01-2	10	50.314.085.01-2	43.621.410.01-2 43.624.410.01-2	34.614.085.01-2
52.412.117.01-2	12			

DYNAMIC MILLING TOOL		
DYNAMIC MILLING TOOL	SHANK	α_{di}
33.345.856.01-2	3	25°
33.445.856.01-2	4	
33.645.856.01-2	6	

DYNAMIC SCREWS			
DYNAMIC SCREW	HIGH DYNAMIC SCREW	DYNAMIC SCREWDRIVER	SCREWDRIVER LENGTH (mm)
41.316.081.01-2	-	43.618.201.01-2 43.624.201.01-2 43.632.201.01-2	18 24 32

STRAIGHT SCREWS	
STRAIGHT SCREW	SCREWDRIVER Hex. 1.25
40.316.004.02-2	43.601.104.01-2

ANALOG	LAB SCANBODY
-	30.413.002.01-2

LIBRARY OPTIONS

GH = Gingival Height α_s - Standard maximum angulation
CH = Cement Height α_c - Captive maximum angulation
IG = Adaptor 3mm α_d - Direct to implant maximum angulation
R = Rotational / Non-Engaging
NR = Non Rotational / Engaging

STANDARD DYNAMIC TIBASE															
	GINGIVAL HEIGHT	α_s	α_c	GINGIVAL HEIGHT	α_s	α_c	GINGIVAL HEIGHT	α_s	α_c	GINGIVAL HEIGHT	α_s	α_c	GINGIVAL HEIGHT	α_s	α_c
	1 mm			mm			mm			mm			mm		
R	31.325.086.01-2	45°	30°	-	-	-	-	-	-	-	-	-	-	-	-
NR	31.315.086.01-2			-	-	-	-	-	-	-	-	-	-	-	-

DYNAMIC 3TIBASE				
	GINGIVAL HEIGHT	α_s	α_c	α_d
		CH-5mm	CH-7mm	CH-9mm
R	-	-	-	-
NR	-	-	-	-

DYNAMIC SCANBODY (LAB/CLIN)				DIGITAL ANALOG
SCANBODY	HEIGHT mm	ADAPTOR	SCREWDRIVER ADAPTOR	DIGITAL ANALOG
52.410.117.01-2	10	50.314.085.01-2	43.621.410.01-2 43.624.410.01-2	-
52.412.117.01-2	12			

DYNAMIC MILLING TOOL		
DYNAMIC MILLING TOOL	SHANK	α_{di}
33.345.856.01-2	3	25°
33.445.856.01-2	4	
33.645.856.01-2	6	

DYNAMIC SCREWS			
DYNAMIC SCREW	HIGH DYNAMIC SCREW	DYNAMIC SCREWDRIVER	SCREWDRIVER LENGTH (mm)
41.316.081.01-2	-	43.618.201.01-2 43.624.201.01-2 43.632.201.01-2	18 24 32

STRAIGHT SCREWS	
STRAIGHT SCREW	SCREWDRIVER Hex. 1.25
40.316.004.02-2	43.601.104.01-2

ANALOG	LAB SCANBODY
-	30.415.007.01-2

LIBRARY OPTIONS

GH = Gingival Height α_s - Standard maximum angulation
CH = Cement Height α_c - Captive maximum angulation
IG = Adaptor 3mm α_d - Direct to implant maximum angulation
R = Rotational / Non-Engaging
NR = Non Rotational / Engaging

STANDARD DYNAMIC TIBASE															
	GINGIVAL HEIGHT	α_s	α_c	GINGIVAL HEIGHT	α_s	α_c	GINGIVAL HEIGHT	α_s	α_c	GINGIVAL HEIGHT	α_s	α_c	GINGIVAL HEIGHT	α_s	α_c
	0.3 mm			mm			mm			mm			mm		
R	31.321.087.01-2	25°	-	-	-	-	-	-	-	-	-	-	-	-	-
NR	31.311.087.01-2		-	-	-	-	-	-	-	-	-	-	-	-	-

DYNAMIC 3TIBASE								
	GINGIVAL HEIGHT	α_s	α_s	α_s	GINGIVAL HEIGHT	α_s	α_s	α_s
	0.3 mm	CH-5mm	CH- 7mm	CH- 9mm	2 mm	CH-5mm	CH- 7mm	CH- 9mm
R	-	20°	20°	15°	-	25°	20°	15°
NR	31.311.087.21-2				31.311.087.23-2			

DYNAMIC SCANBODY (LAB/CLIN)				DIGITAL ANALOG	DYNAMIC MILLING TOOL		
SCANBODY	HEIGHT mm	ADAPTOR	SCREWDRIVER ADAPTOR	DIGITAL ANALOG	DYNAMIC MILLING TOOL	SHANK	α_{di}
52.410.132.01-2	10	50.311.087.04-2 (IG-3mm)	43.621.415.01-2	-	-	-	-
					-	-	
52.412.132.01-2	12				-	-	

DYNAMIC SCREWS				STRAIGHT SCREWS		ANALOG		LAB SCANBODY	
DYNAMIC SCREW	HIGH DYNAMIC SCREW	DYNAMIC SCREWDRIVER	SCREWDRIVER LENGTH (mm)	STRAIGHT SCREW	SCREWDRIVER Hex. 1.27				
41.316.094.01-2	-	43.618.201.01-2	18	40.316.005.04-2	43.601.105.01-2	-	-	-	30.410.006.01-2
		43.624.201.01-2	24						
		43.632.201.01-2	32						

LIBRARY OPTIONS
GH = Gingival Height α_s - Standard maximum angulation
CH = Cement Height α_c - Captive maximum angulation
IG = Adaptor 3mm α_{di} - Direct to implant maximum angulation
R = Rotational / Non-Engaging
NR = Non Rotational / Engaging

STANDARD DYNAMIC TIBASE															
	GINGIVAL HEIGHT	α_s	α_c	GINGIVAL HEIGHT	α_s	α_c	GINGIVAL HEIGHT	α_s	α_c	GINGIVAL HEIGHT	α_s	α_c	GINGIVAL HEIGHT	α_s	α_c
	0.3 mm			mm			mm			mm			mm		
R	31.324.088.01-2	25°	-	-	-	-	-	-	-	-	-	-	-	-	-
NR	31.314.088.01-2		-	-	-	-	-	-	-	-	-	-	-	-	-

DYNAMIC 3TIBASE				
	GINGIVAL HEIGHT	α_s	α_s	α_s
	0.3 mm	CH-5mm	CH- 7mm	CH- 9mm
R	-	-	-	-
NR	-			

DYNAMIC SCANBODY (LAB/CLIN)				DIGITAL ANALOG	DYNAMIC MILLING TOOL		
SCANBODY	HEIGHT mm	ADAPTOR	SCREWDRIVER ADAPTOR	DIGITAL ANALOG	DYNAMIC MILLING TOOL	SHANK	α_{di}
-	-	-	-	-	-	-	-
-	-				-	-	
-	-				-	-	

DYNAMIC SCREWS				STRAIGHT SCREWS		ANALOG		LAB SCANBODY	
DYNAMIC SCREW	HIGH DYNAMIC SCREW	DYNAMIC SCREWDRIVER	SCREWDRIVER LENGTH (mm)	STRAIGHT SCREW	SCREWDRIVER Hex. 1.27				
41.320.094.01-2	-	43.618.201.01-2	18	40.320.005.04-2	43.601.105.01-2	-	-	-	30.414.003.01-2
		43.624.201.01-2	24						
		43.632.201.01-2	32						

LIBRARY OPTIONS
GH = Gingival Height α_s - Standard maximum angulation
CH = Cement Height α_c - Captive maximum angulation
IG = Adaptor 3mm α_{di} - Direct to implant maximum angulation
R = Rotational / Non-Engaging
NR = Non Rotational / Engaging

STANDARD DYNAMIC TIBASE															
	GINGIVAL HEIGHT	α_s	α_c	GINGIVAL HEIGHT	α_s	α_c	GINGIVAL HEIGHT	α_s	α_c	GINGIVAL HEIGHT	α_s	α_c	GINGIVAL HEIGHT	α_s	α_c
	1 mm			2 mm			3 mm			mm			mm		
R	31.321.090.01-2	45°	24°	31.321.090.02-2	25°	-	31.321.090.03-2	20°	-	-	-	-	-	-	-
NR	31.311.090.01-2			31.311.090.02-2			31.311.090.03-2			-			-		

DYNAMIC 3TIBASE

	GINGIVAL HEIGHT	α_s	α_c	α_s
	1 mm	CH-5mm	CH-7mm	CH-9mm
R	-	30°	25°	15°
NR	31.311.090.21-2			

DYNAMIC SCANBODY (LAB/CLIN) DIGITAL ANALOG

SCANBODY	HEIGHT mm	ADAPTOR	SCREWDRIVER ADAPTOR	DIGITAL ANALOG
52.410.128.01-2	10	50.311.090.03-2 (IG=3mm)	43.621.415.01-2	34.611.090.01-2
-	-			
-	-			

DYNAMIC MILLING TOOL

DYNAMIC MILLING TOOL	SHANK	α_{di}
33.325.472.01-2*	3	25°
33.425.472.01-2*	4	
33.625.472.01-2*	6	

*Only for R
*Only for titanium and soft materials

DYNAMIC SCREWS

DYNAMIC SCREW	HIGH DYNAMIC SCREW	DYNAMIC SCREWDRIVER	SCREWDRIVER LENGTH (mm)
41.314.074.01-2	-	43.618.201.01-2	18
		43.624.201.01-2	24
		43.632.201.01-2	32

STRAIGHT SCREWS

STRAIGHT SCREW	SCREWDRIVER Hex. 1.27
40.314.005.01-2	43.601.105.01-2

ANALOG	LAB SCANBODY
-	30.410.006.01-2

LIBRARY OPTIONS
GH = Gingival Height α_s - Standard maximum angulation
CH = Cement Height α_c - Captive maximum angulation
IG = Adaptor 3mm α_{di} - Direct to implant maximum angulation
R = Rotational / Non-Engaging
NR = Non Rotational / Engaging

STANDARD DYNAMIC TIBASE															
	GINGIVAL HEIGHT	α_s	α_c	GINGIVAL HEIGHT	α_s	α_c	GINGIVAL HEIGHT	α_s	α_c	GINGIVAL HEIGHT	α_s	α_c	GINGIVAL HEIGHT	α_s	α_c
	1.2 mm			2 mm			3 mm			4 mm			mm		
R	31.324.091.01-2	38°	18°	31.324.091.02-2	25°	-	31.324.091.03-2	20°	-	31.324.091.04-2	15°	-	-	-	-
NR	31.314.091.01-2			31.314.091.02-2			31.314.091.03-2			31.314.091.04-2			-		

DYNAMIC 3TIBASE

	GINGIVAL HEIGHT	α_s	α_c	α_s
	1.2 mm	CH-5mm	CH-7mm	CH-9mm
R	-	30°	25°	15°
NR	31.314.091.21-2			

DYNAMIC SCANBODY (LAB/CLIN) DIGITAL ANALOG

SCANBODY	HEIGHT mm	ADAPTOR	SCREWDRIVER ADAPTOR	DIGITAL ANALOG
52.410.102.01-2	10	50.314.091.03-2 (IG=3mm)	43.621.410.01-2 43.624.410.01-2	34.614.091.01-2
-	-			
52.412.102.01-2	12			

DYNAMIC MILLING TOOL

DYNAMIC MILLING TOOL	SHANK	α_{di}
33.390.958.01-2	3	30°
33.490.958.01-2	4	
33.690.958.01-2	6	

DYNAMIC SCREWS

DYNAMIC SCREW	HIGH DYNAMIC SCREW	DYNAMIC SCREWDRIVER	SCREWDRIVER LENGTH (mm)
41.320.082.01-2	41.320.129.01-2	43.618.201.01-2	18
		43.624.201.01-2	24
		43.632.201.01-2	32

STRAIGHT SCREWS

STRAIGHT SCREW	SCREWDRIVER Hex. 1.27
40.320.005.01-2	43.601.105.01-2

ANALOG	LAB SCANBODY
-	30.413.002.01-2

MULTI-UNIT

	GINGIVAL HEIGHT	GINGIVAL HEIGHT	GINGIVAL HEIGHT	GINGIVAL HEIGHT
	1 mm	2 mm	3 mm	4 mm
R	42.303.091.01-2	42.303.091.02-2	42.303.091.03-2	42.303.091.04-2

LIBRARY OPTIONS
GH = Gingival Height α_s - Standard maximum angulation
CH = Cement Height α_c - Captive maximum angulation
IG = Adaptor 3mm α_{di} - Direct to implant maximum angulation
R = Rotational / Non-Engaging
NR = Non Rotational / Engaging

STANDARD DYNAMIC TIBASE															
	GINGIVAL HEIGHT	α_s	α_c	GINGIVAL HEIGHT	α_s	α_c	GINGIVAL HEIGHT	α_s	α_c	GINGIVAL HEIGHT	α_s	α_c	GINGIVAL HEIGHT	α_s	α_c
	1 mm			2 mm			3 mm			mm			mm		
R	31.325.092.01-2	45°	25°	31.325.092.02-2	25°	-	31.325.092.03-2	20°	-	-	-	-	-	-	-
NR	31.315.092.01-2			31.315.092.02-2			31.315.092.03-2			-			-		

DYNAMIC 3TIBASE				
	GINGIVAL HEIGHT	α_s	α_c	α_s
	1 mm	CH+5mm	CH+ 7mm	CH+ 9mm
R	-	30°	25°	15°
NR	31.315.092.21-2			

DYNAMIC SCANBODY (LAB/CLIN)				DIGITAL ANALOG
SCANBODY	HEIGHT mm	ADAPTOR	SCREWDRIVER ADAPTOR	DIGITAL ANALOG
52.410.129.01-2	10	50.315.092.01-2 50.315.092.03-2 (IG=3mm)	43.621.410.01-2 43.624.410.01-2	34.615.092.01-2
-	-			
-	-			

DYNAMIC MILLING TOOL		
DYNAMIC MILLING TOOL	SHANK	α_{di}
33.390.958.01-2	3	30°
33.490.958.01-2	4	
33.690.958.01-2	6	

DYNAMIC SCREWS			
DYNAMIC SCREW	HIGH DYNAMIC SCREW	DYNAMIC SCREWDRIVER	SCREWDRIVER LENGTH (mm)
41.320.082.01-2	-	43.618.201.01-2	18
		43.624.201.01-2	24
		43.632.201.01-2	32

STRAIGHT SCREWS	
STRAIGHT SCREW	SCREWDRIVER Hex. 1.27
40.320.005.01-2	43.601.105.01-2

ANALOG	LAB SCANBODY
-	30.415.007.01-2

LIBRARY OPTIONS

GH = Gingival Height α_s - Standard maximum angulation
CH = Cement Height α_c - Captive maximum angulation
IG = Adaptor 3mm α_s - Direct to implant maximum angulation
R = Rotational / Non-Engaging
NR = Non Rotational / Engaging

STANDARD DYNAMIC TIBASE															
	GINGIVAL HEIGHT	α_s	α_c	GINGIVAL HEIGHT	α_s	α_c	GINGIVAL HEIGHT	α_s	α_c	GINGIVAL HEIGHT	α_s	α_c	GINGIVAL HEIGHT	α_s	α_c
	0.6 mm			mm			mm			mm			mm		
R	31.324.096.01-2	45°	30°	-	-	-	-	-	-	-	-	-	-	-	-
NR	31.314.096.01-2			-			-			-			-		

DYNAMIC 3TIBASE				
	GINGIVAL HEIGHT	α_s	α_c	α_s
		CH+5mm	CH+ 7mm	CH+ 9mm
R	-	-	-	-
NR	-			

DYNAMIC SCANBODY (LAB/CLIN)				DIGITAL ANALOG
SCANBODY	HEIGHT mm	ADAPTOR	SCREWDRIVER ADAPTOR	DIGITAL ANALOG
52.408.110.01-2	8	50.314.096.01-2	43.621.410.01-2 43.624.410.01-2	34.614.096.01-2
52.410.110.01-2	10			
52.412.110.01-2	12			

DYNAMIC MILLING TOOL		
DYNAMIC MILLING TOOL	SHANK	α_{di}
33.315.708.01-2	3	30°
33.415.708.01-2	4	
33.615.708.01-2	6	

SCANALOG
23.414.096.01-2

DYNAMIC SCREWS			
DYNAMIC SCREW	HIGH DYNAMIC SCREW	DYNAMIC SCREWDRIVER	SCREWDRIVER LENGTH (mm)
41.320.067.01-2	-	43.618.201.01-2	18
		43.624.201.01-2	24
		43.632.201.01-2	32

STRAIGHT SCREWS	
STRAIGHT SCREW	SCREWDRIVER TORX T6
40.320.007.01-2	43.601.107.01-2

ANALOG	LAB SCANBODY
22.614.096.01-2	30.414.008.01-2

LIBRARY OPTIONS

GH = Gingival Height α_s - Standard maximum angulation
CH = Cement Height α_c - Captive maximum angulation
IG = Adaptor 3mm α_s - Direct to implant maximum angulation
R = Rotational / Non-Engaging
NR = Non Rotational / Engaging

STANDARD DYNAMIC TIBASE															
	GINGIVAL HEIGHT	α_s	α_c	GINGIVAL HEIGHT	α_s	α_c	GINGIVAL HEIGHT	α_s	α_c	GINGIVAL HEIGHT	α_s	α_c	GINGIVAL HEIGHT	α_s	α_c
	0.5 mm			mm			mm			mm			mm		
R	31.323.101.01-2	45°	30°	-	-	-	-	-	-	-	-	-	-	-	-
NR	-			-	-	-	-	-	-	-	-	-	-	-	-

DYNAMIC 3TIBASE

	GINGIVAL HEIGHT	α_s	α_s	α_s
		CH+5mm	CH+7mm	CH+9mm
R	-	-	-	-
NR	-	-	-	-

DYNAMIC SCANBODY (LAB/CLIN) DIGITAL ANALOG DYNAMIC MILLING TOOL SCANALOG

SCANBODY	HEIGHT mm	ADAPTOR	SCREWDRIVER ADAPTOR	DIGITAL ANALOG	DYNAMIC MILLING TOOL	SHANK	α_{di}	SCANALOG
52.409.133.01-2	9	50.313.101.01-2	43.621.410.01-2 43.624.410.01-2	34.613.101.01-2	33.335.676.01-2	3	30°	23.413.101.01-2
					33.435.676.01-2	4		
					33.635.676.01-2	6		
-	-							

REFERENCE SCANBODY

SCANBODY	PEEK PINS	mm
54.322.101.31-2	49.414.000.01-2	6
	49.415.000.01-2	9
	49.416.000.01-2	13
	CAPS	mm
	49.418.000.01-2	3.8
	49.419.000.01-2	6
	49.420.000.01-2	8

SCREWDRIVER 43.601.107.01-2

DYNAMIC SCREWS

DYNAMIC SCREW	HIGH DYNAMIC SCREW	DYNAMIC SCREWDRIVER	SCREWDRIVER LENGTH (mm)
41.314.043.01-2	-	43.618.201.01-2	18
		43.624.201.01-2	24
		43.632.201.01-2	32

STRAIGHT SCREWS

STRAIGHT SCREW	SCREWDRIVER TORX T6
40.314.007.01-2	43.601.107.01-2

ANALOG	LAB SCANBODY
-	30.413.005.01-2

LIBRARY OPTIONS

- GH** = Gingival Height
- CH** = Cement Height
- IG** = Adaptor 3mm
- α_s - Standard maximum angulation
- α_c - Captive maximum angulation
- α_{di} - Direct to implant maximum angulation
- R** = Rotational / Non-Engaging
- NR** = Non Rotational / Engaging

STANDARD DYNAMIC TIBASE															
	GINGIVAL HEIGHT	α_s	α_c	GINGIVAL HEIGHT	α_s	α_c	GINGIVAL HEIGHT	α_s	α_c	GINGIVAL HEIGHT	α_s	α_c	GINGIVAL HEIGHT	α_s	α_c
	1.8 mm			mm			mm			mm			mm		
R	31.322.102.01-2	38°	18°	-	-	-	-	-	-	-	-	-	-	-	-
NR	31.312.102.01-2			-	-	-	-	-	-	-	-	-	-	-	-

DYNAMIC 3TIBASE

	GINGIVAL HEIGHT	α_s	α_s	α_s	GINGIVAL HEIGHT	α_s	α_s	α_s	GINGIVAL HEIGHT	α_s	α_s	α_s
	1 mm	CH+5mm	CH+7mm	CH+9mm	1.8 mm	CH+5mm	CH+7mm	CH+9mm	3 mm	CH+5mm	CH+7mm	CH+9mm
R	31.322.102.29-2	30°	25°	20°	31.322.102.21-2	25°	15°	10°	31.322.102.23-2	20°	20°	15°
NR	31.312.102.29-2				31.312.102.21-2				31.312.102.23-2			

DYNAMIC SCANBODY (LAB/CLIN) DIGITAL ANALOG DYNAMIC MILLING TOOL SCANALOG SCANBODY OP

SCANBODY	HEIGHT mm	ADAPTOR	SCREWDRIVER ADAPTOR	DIGITAL ANALOG	DYNAMIC MILLING TOOL	SHANK	α_{di}	SCANALOG	SCANBODY	PEEK PINS	mm
52.410.128.01-2	10	50.312.102.03-2 (IG-3mm)	43.621.415.01-2	34.612.102.01-2	-	-	-	23.412.102.01-2	54.315.102.21-2	49.414.000.01-2	6
					-	-				49.415.000.01-2	9
-	-				-	-				49.416.000.01-2	13

SCREWDRIVER 43.625.105.01-2

DYNAMIC SCREWS

DYNAMIC SCREW	HIGH DYNAMIC SCREW	DYNAMIC SCREWDRIVER	SCREWDRIVER LENGTH (mm)
41.317.065.01-2	-	43.618.201.01-2	18
		43.624.201.01-2	24
		43.632.201.01-2	32

STRAIGHT SCREWS

STRAIGHT SCREW	SCREWDRIVER Hex. 1.27
40.317.005.02-2	43.601.105.01-2

ANALOG	LAB SCANBODY
-	30.412.001.01-2

MULTI-UNIT

	GINGIVAL HEIGHT	GINGIVAL HEIGHT	GINGIVAL HEIGHT	GINGIVAL HEIGHT
	1 mm	2 mm	3 mm	4 mm
R	42.302.102.01-2	42.302.102.02-2	42.302.102.03-2	42.302.102.04-2

LIBRARY OPTIONS

- GH** = Gingival Height
- CH** = Cement Height
- IG** = Adaptor 3mm
- α_s - Standard maximum angulation
- α_c - Captive maximum angulation
- α_{di} - Direct to implant maximum angulation
- R** = Rotational / Non-Engaging
- NR** = Non Rotational / Engaging

STANDARD DYNAMIC TIBASE															
	GINGIVAL HEIGHT	α_s	α_c	GINGIVAL HEIGHT	α_s	α_c	GINGIVAL HEIGHT	α_s	α_c	GINGIVAL HEIGHT	α_s	α_c	GINGIVAL HEIGHT	α_s	α_c
	1.2 mm			mm			mm			mm			mm		
R	31.322.109.01-2	45°	29°	-	-	-	-	-	-	-	-	-	-	-	-
NR	31.312.109.01-2			-	-	-	-	-	-	-	-	-	-	-	-

DYNAMIC 3TIBASE				
	GINGIVAL HEIGHT	α_s	α_c	α_s
		CH-5mm	CH-7mm	CH-9mm
R	-	-	-	-
NR	-	-	-	-

DYNAMIC SCANBODY (LAB/CLIN)				DIGITAL ANALOG
SCANBODY	HEIGHT mm	ADAPTOR	SCREWDRIVER ADAPTOR	DIGITAL ANALOG
52.410.128.01-2	10	50.312.109.01-2	43.621.415.01-2	34.612.109.01-2
-	-			
-	-			

DYNAMIC MILLING TOOL		
DYNAMIC MILLING TOOL	SHANK	α_{di}
33.360.754.01-2*	3	25°
33.460.754.01-2*	4	
33.660.754.01-2*	6	

*Only for R

DYNAMIC SCREWS			
DYNAMIC SCREW	HIGH DYNAMIC SCREW	DYNAMIC SCREWDRIVER	SCREWDRIVER LENGTH (mm)
41.314.070.01-2	-	43.618.201.01-2	18
		43.624.201.01-2	24
		43.632.201.01-2	32

STRAIGHT SCREWS	
STRAIGHT SCREW	SCREWDRIVER Hex. 1.27
40.314.005.02-2	43.601.105.01-2

ANALOG	LAB SCANBODY
-	30.412.001.01-2

LIBRARY OPTIONS

- GH = Gingival Height α_s - Standard maximum angulation
- CH = Cement Height α_c - Captive maximum angulation
- IG = Adaptor 3mm α_s - Direct to implant maximum angulation
- R = Rotational / Non-Engaging
- NR = Non Rotational / Engaging

STANDARD DYNAMIC TIBASE															
	GINGIVAL HEIGHT	α_s	α_c	GINGIVAL HEIGHT	α_s	α_c	GINGIVAL HEIGHT	α_s	α_c	GINGIVAL HEIGHT	α_s	α_c	GINGIVAL HEIGHT	α_s	α_c
	0.4 mm			mm			mm			mm			mm		
R	31.320.110.01-2	45°	30°	-	-	-	-	-	-	-	-	-	-	-	-
NR	31.310.110.01-2			-	-	-	-	-	-	-	-	-	-	-	-

DYNAMIC 3TIBASE				
	GINGIVAL HEIGHT	α_s	α_c	α_s
		CH-5mm	CH-7mm	CH-9mm
R	-	-	-	-
NR	-	-	-	-

DYNAMIC SCANBODY (LAB/CLIN)				DIGITAL ANALOG
SCANBODY	HEIGHT mm	ADAPTOR	SCREWDRIVER ADAPTOR	DIGITAL ANALOG
52.410.117.01-2	10	50.310.110.04-2 IG-3mm	43.621.410.01-2 43.624.410.01-2	34.610.110.01-2
-	-			
52.412.117.01-2	12			

DYNAMIC MILLING TOOL		
DYNAMIC MILLING TOOL	SHANK	α_{di}
33.360.756.01-2	3	20°
33.460.756.01-2	4	
33.660.756.01-2	6	

DYNAMIC SCREWS			
DYNAMIC SCREW	HIGH DYNAMIC SCREW	DYNAMIC SCREWDRIVER	SCREWDRIVER LENGTH (mm)
41.318.083.01-2	-	43.618.201.01-2	18
		43.624.201.01-2	24
		43.632.201.01-2	32

STRAIGHT SCREWS	
STRAIGHT SCREW	SCREWDRIVER TORX T6
40.318.007.01-2	43.601.107.01-2

ANALOG	LAB SCANBODY
-	30.410.006.01-2

LIBRARY OPTIONS

- GH = Gingival Height α_s - Standard maximum angulation
- CH = Cement Height α_c - Captive maximum angulation
- IG = Adaptor 3mm α_s - Direct to implant maximum angulation
- R = Rotational / Non-Engaging
- NR = Non Rotational / Engaging

STANDARD DYNAMIC TIBASE															
	GINGIVAL HEIGHT	α_s	α_c	GINGIVAL HEIGHT	α_s	α_c	GINGIVAL HEIGHT	α_s	α_c	GINGIVAL HEIGHT	α_s	α_c	GINGIVAL HEIGHT	α_s	α_c
	0.4 mm			mm			mm			mm			mm		
R	31.323.111.01-2	45°	30°	-	-	-	-	-	-	-	-	-	-	-	-
NR	31.313.111.01-2			-	-	-	-	-	-	-	-	-	-	-	-

DYNAMIC 3TIBASE

	GINGIVAL HEIGHT	α_s	α_c	α_s
		CH-5mm	CH-7mm	CH-9mm
R	-	-	-	-
NR	-	-	-	-

DYNAMIC SCANBODY (LAB/CLIN) DIGITAL ANALOG

SCANBODY	HEIGHT mm	ADAPTOR	SCREWDRIVER ADAPTOR	DIGITAL ANALOG
52.410.117.01-2	10	50.310.110.04-2 IG-3mm	43.621.410.01-2 43.624.410.01-2	34.610.110.01-2
52.412.117.01-2	12			

DYNAMIC MILLING TOOL

DYNAMIC MILLING TOOL	SHANK	α_{di}
33.360.756.01-2	3	20°
33.460.756.01-2	4	
33.660.756.01-2	6	

DYNAMIC SCREWS

DYNAMIC SCREW	HIGH DYNAMIC SCREW	DYNAMIC SCREWDRIVER	SCREWDRIVER LENGTH (mm)
41.318.083.01-2	-	43.618.201.01-2	18
		43.624.201.01-2	24
		43.632.201.01-2	32

STRAIGHT SCREWS

STRAIGHT SCREW	SCREWDRIVER TORX T6
40.318.007.01-2	43.601.107.01-2

ANALOG	LAB SCANBODY
-	30.413.002.01-2

LIBRARY OPTIONS
GH = Gingival Height α_s - Standard maximum angulation
CH = Cement Height α_c - Captive maximum angulation
IG = Adaptor 3mm α_{di} - Direct to implant maximum angulation
R = Rotational / Non-Engaging
NR = Non Rotational / Engaging

STANDARD DYNAMIC TIBASE															
	GINGIVAL HEIGHT	α_s	α_c	GINGIVAL HEIGHT	α_s	α_c	GINGIVAL HEIGHT	α_s	α_c	GINGIVAL HEIGHT	α_s	α_c	GINGIVAL HEIGHT	α_s	α_c
	1 mm			2 mm			mm			mm			mm		
R	31.321.119.01-2	35°	-	31.321.119.02-2	30°	-	-	-	-	-	-	-	-	-	-
NR	31.311.119.01-2			31.311.119.02-2			-	-	-	-	-	-	-	-	-

DYNAMIC 3TIBASE

	GINGIVAL HEIGHT	α_s	α_c	α_s
		CH-5mm	CH-7mm	CH-9mm
R	-	-	-	-
NR	-	-	-	-

DYNAMIC SCANBODY (LAB/CLIN) DIGITAL ANALOG

SCANBODY	HEIGHT mm	ADAPTOR	SCREWDRIVER ADAPTOR	DIGITAL ANALOG
52.410.132.01-2	10	50.311.119.03-2 IG-3mm	43.621.415.01-2	34.611.119.01-2
52.412.132.01-2	12			

DYNAMIC MILLING TOOL

DYNAMIC MILLING TOOL	SHANK	α_{di}
33.360.756.01-2	3	25
33.460.756.01-2	4	
33.660.756.01-2	6	

DYNAMIC SCREWS

DYNAMIC SCREW	HIGH DYNAMIC SCREW	DYNAMIC SCREWDRIVER	SCREWDRIVER LENGTH (mm)
41.316.080.01-2	-	43.618.201.01-2	18
		43.624.201.01-2	24
		43.632.201.01-2	32

STRAIGHT SCREWS

STRAIGHT SCREW	SCREWDRIVER Hex. 1,27
40.316.005.07-2	43.601.105.01-2

ANALOG	LAB SCANBODY
-	30.410.006.01-2

MULTI-UNIT

	GINGIVAL HEIGHT	GINGIVAL HEIGHT	GINGIVAL HEIGHT	GINGIVAL HEIGHT
	1 mm	2 mm	3 mm	4 mm
R	42.301.119.01-2	42.301.119.02-2	42.301.119.03-2	42.301.119.04-2

LIBRARY OPTIONS
GH = Gingival Height α_s - Standard maximum angulation
CH = Cement Height α_c - Captive maximum angulation
IG = Adaptor 3mm α_{di} - Direct to implant maximum angulation
R = Rotational / Non-Engaging
NR = Non Rotational / Engaging

STANDARD DYNAMIC TIBASE															
	GINGIVAL HEIGHT	α_s	α_c	GINGIVAL HEIGHT	α_s	α_c	GINGIVAL HEIGHT	α_s	α_c	GINGIVAL HEIGHT	α_s	α_c	GINGIVAL HEIGHT	α_s	α_c
	1 mm			mm			mm			mm			mm		
R	31.323.121.01-2	45°	25°	-	-	-	-	-	-	-	-	-	-	-	-
NR	31.313.121.01-2			-	-	-	-	-	-	-	-	-	-	-	-

DYNAMIC 3TIBASE								
	GINGIVAL HEIGHT	α_s	α_s	α_s	GINGIVAL HEIGHT	α_s	α_s	α_s
	2mm	CH-5mm	CH- 7mm	CH- 9mm	3mm	CH-5mm	CH- 7mm	CH- 9mm
R	-	25°	20°	15°	-	25°	20°	10°
NR	31.313.121.22-2				31.313.121.23-2			

DYNAMIC SCANBODY (LAB/CLIN)				DIGITAL ANALOG
SCANBODY	HEIGHT mm	ADAPTOR	SCREWDRIVER ADAPTOR	DIGITAL ANALOG
52.410.108.01-2	10	50.312.120.03-2 <i>IG-3mm</i>	43.621.410.01-2 43.624.410.01-2	34.612.120.01-2
52.412.108.01-2	12			

DYNAMIC MILLING TOOL		
DYNAMIC MILLING TOOL	SHANK	α_{di}
33.360.754.01-2	3	20°
33.460.754.01-2	4	
33.660.754.01-2	6	

DYNAMIC SCREWS			
DYNAMIC SCREW	HIGH DYNAMIC SCREW	DYNAMIC SCREWDRIVER	SCREWDRIVER LENGTH (mm)
41.316.080.01-2	-	43.618.201.01-2	18
		43.624.201.01-2	24
		43.632.201.01-2	32

STRAIGHT SCREWS	
STRAIGHT SCREW	SCREWDRIVER Hex. 1.27
40.316.005.07-2	43.601.105.01-2

ANALOG	LAB SCANBODY
-	30.413.002.01-2

MULTI-UNIT				
	GINGIVAL HEIGHT	GINGIVAL HEIGHT	GINGIVAL HEIGHT	GINGIVAL HEIGHT
	1 mm	2 mm	3 mm	4 mm
R	42.303.121.01-2	42.303.121.02-2	42.303.121.03-2	42.303.121.04-2

LIBRARY OPTIONS

GH = Gingival Height α_s - Standard maximum angulation
CH = Cement Height α_c - Captive maximum angulation
IG = Adaptor 3mm α_{di} - Direct to implant maximum angulation
R = Rotational / Non-Engaging
NR = Non Rotational / Engaging

STANDARD DYNAMIC TIBASE															
	GINGIVAL HEIGHT	α_s	α_c	GINGIVAL HEIGHT	α_s	α_c	GINGIVAL HEIGHT	α_s	α_c	GINGIVAL HEIGHT	α_s	α_c	GINGIVAL HEIGHT	α_s	α_c
	1 mm			mm			mm			mm			mm		
R	31.323.121.01-2	45°	25°	-	-	-	-	-	-	-	-	-	-	-	-
NR	31.313.121.01-2			-	-	-	-	-	-	-	-	-	-	-	-

DYNAMIC 3TIBASE								
	GINGIVAL HEIGHT	α_s	α_s	α_s	GINGIVAL HEIGHT	α_s	α_s	α_s
	2mm	CH-5mm	CH- 7mm	CH- 9mm	3mm	CH-5mm	CH- 7mm	CH- 9mm
R	-	25°	20°	15°	-	25°	20°	10°
NR	31.313.121.22-2				31.313.121.23-2			

DYNAMIC SCANBODY (LAB/CLIN)				DIGITAL ANALOG
SCANBODY	HEIGHT mm	ADAPTOR	SCREWDRIVER ADAPTOR	DIGITAL ANALOG
52.410.109.01-2	10	50.313.121.01-2	43.621.410.01-2 43.624.410.01-2	34.613.121.01-2
52.412.109.01-2	12	50.313.121.03-2 <i>IG-3mm</i>		

DYNAMIC MILLING TOOL		
DYNAMIC MILLING TOOL	SHANK	α_{di}
33.360.754.01-2	3	20°
33.460.754.01-2	4	
33.660.754.01-2	6	

DYNAMIC SCREWS			
DYNAMIC SCREW	HIGH DYNAMIC SCREW	DYNAMIC SCREWDRIVER	SCREWDRIVER LENGTH (mm)
41.316.080.01-2	-	43.618.201.01-2	18
		43.624.201.01-2	24
		43.632.201.01-2	32

STRAIGHT SCREWS	
STRAIGHT SCREW	SCREWDRIVER Hex. 1.27
40.316.005.07-2	43.601.105.01-2

ANALOG	LAB SCANBODY
-	30.413.002.01-2

MULTI-UNIT				
	GINGIVAL HEIGHT	GINGIVAL HEIGHT	GINGIVAL HEIGHT	GINGIVAL HEIGHT
	1 mm	2 mm	3 mm	4 mm
R	42.303.121.01-2	42.303.121.02-2	42.303.121.03-2	42.303.121.04-2

LIBRARY OPTIONS

GH = Gingival Height α_s - Standard maximum angulation
CH = Cement Height α_c - Captive maximum angulation
IG = Adaptor 3mm α_{di} - Direct to implant maximum angulation
R = Rotational / Non-Engaging
NR = Non Rotational / Engaging

STANDARD DYNAMIC TIBASE															
	GINGIVAL HEIGHT	α_s	α_c	GINGIVAL HEIGHT	α_s	α_c	GINGIVAL HEIGHT	α_s	α_c	GINGIVAL HEIGHT	α_s	α_c	GINGIVAL HEIGHT	α_s	α_c
	1.4 mm			mm			mm			mm			mm		
R	31.324.124.01-2	42°	19°	-	-	-	-	-	-	-	-	-	-	-	-
NR	31.314.124.01-2			-	-	-	-	-	-	-	-	-	-	-	-

DYNAMIC 3TIBASE				
	GINGIVAL HEIGHT	α_s	α_s	α_s
		CH+5mm	CH+ 7mm	CH+ 9mm
R	-	-	-	-
NR	-	-	-	-

DYNAMIC SCANBODY (LAB/CLIN)				DIGITAL ANALOG
SCANBODY	HEIGHT mm	ADAPTOR	SCREWDRIVER ADAPTOR	DIGITAL ANALOG
52.410.125.01-2	10	50.314.124.01-2	43.621.410.01-2 43.624.410.01-2	34.614.124.01-2
-	-			
-	-			

DYNAMIC MILLING TOOL		
DYNAMIC MILLING TOOL	SHANK	α_{di}
33.335.758.01-2	3	30°
33.435.758.01-2	4	
33.635.758.01-2	6	

DYNAMIC SCREWS			
DYNAMIC SCREW	HIGH DYNAMIC SCREW	DYNAMIC SCREWDRIVER	SCREWDRIVER LENGTH (mm)
41.320.075.01-2	-	43.618.201.01-2	18
		43.624.201.01-2	24
		43.632.201.01-2	32

STRAIGHT SCREWS	
STRAIGHT SCREW	SCREWDRIVER UNIGRIP
40.320.008.02-2	43.601.108.01-2

ANALOG	LAB SCANBODY
-	30.414.003.01-2

LIBRARY OPTIONS
GH = Gingival Height α_s - Standard maximum angulation
CH = Cement Height α_c - Captive maximum angulation
IG = Adaptor 3mm α_s - Direct to implant maximum angulation
R = Rotational / Non-Engaging
NR = Non Rotational / Engaging

STANDARD DYNAMIC TIBASE															
	GINGIVAL HEIGHT	α_s	α_c	GINGIVAL HEIGHT	α_s	α_c	GINGIVAL HEIGHT	α_s	α_c	GINGIVAL HEIGHT	α_s	α_c	GINGIVAL HEIGHT	α_s	α_c
	1.1 mm			2 mm			mm			mm			mm		
R	31.323.125.01-2	42°	20°	31.323.125.02-2	25°	-	-	-	-	-	-	-	-	-	-
NR	31.313.125.01-2			31.313.125.02-2											

DYNAMIC 3TIBASE								
	GINGIVAL HEIGHT	α_s	α_s	α_s	GINGIVAL HEIGHT	α_s	α_s	α_s
	1.1 mm	CH+5mm	CH+ 7mm	CH+ 9mm	3 mm	CH+5mm	CH+ 7mm	CH+ 9mm
R	31.323.125.21-2	30°	25°	15°	-	20°	15°	10°
NR	31.313.125.21-2				31.313.125.23-2			

DYNAMIC SCANBODY (LAB/CLIN)				DIGITAL ANALOG
SCANBODY	HEIGHT mm	ADAPTOR	SCREWDRIVER ADAPTOR	DIGITAL ANALOG
52.410.117.01-2	10	50.313.125.01-2	43.621.410.01-2 43.624.410.01-2	34.613.125.01-2
-	-			
52.412.117.01-2	12	50.313.125.03-2 <small>IG-3mm</small>		

DYNAMIC MILLING TOOL		
DYNAMIC MILLING TOOL	SHANK	α_{di}
33.315.804.01-2	3	25°
33.415.804.01-2	4	
33.615.804.01-2	6	

DYNAMIC SCREWS			
DYNAMIC SCREW	HIGH DYNAMIC SCREW	DYNAMIC SCREWDRIVER	SCREWDRIVER LENGTH (mm)
41.316.078.01-2	-	43.618.201.01-2	18
		43.624.201.01-2	24
		43.632.201.01-2	32

STRAIGHT SCREWS	
STRAIGHT SCREW	SCREWDRIVER TORX T6
40.316.007.01-2	43.601.107.01-2

ANALOG	LAB SCANBODY
-	30.413.002.01-2

MULTI-UNIT				
	GINGIVAL HEIGHT	GINGIVAL HEIGHT	GINGIVAL HEIGHT	GINGIVAL HEIGHT
	1 mm	2 mm	3 mm	4 mm
R	42.303.125.01-2	42.303.125.02-2	42.303.125.03-2	42.303.125.04-2

LIBRARY OPTIONS
GH = Gingival Height α_s - Standard maximum angulation
CH = Cement Height α_c - Captive maximum angulation
IG = Adaptor 3mm α_s - Direct to implant maximum angulation
R = Rotational / Non-Engaging
NR = Non Rotational / Engaging

STANDARD DYNAMIC TIBASE															
	GINGIVAL HEIGHT	α_s	α_c	GINGIVAL HEIGHT	α_s	α_c	GINGIVAL HEIGHT	α_s	α_c	GINGIVAL HEIGHT	α_s	α_c	GINGIVAL HEIGHT	α_s	α_c
	2.5 mm			mm			mm			mm			mm		
R	31.322.128.01-2	45°	30°	-	-	-	-	-	-	-	-	-	-	-	-
NR	-			-	-	-	-	-	-	-	-	-	-	-	-

DYNAMIC 3TIBASE

	CH-5mm	CH- 7mm	CH- 9mm
R	-	-	-
NR	-	-	-

DYNAMIC SCANBODY (LAB/CLIN)				DIGITAL ANALOG
SCANBODY	HEIGHT mm	ADAPTOR	SCREWDRIVER ADAPTOR	DIGITAL ANALOG
-	-	-	-	-
-	-	-	-	-
-	-	-	-	-

DYNAMIC MILLING TOOL		
DYNAMIC MILLING TOOL	SHANK	α_{di}
-	-	-
-	-	-
-	-	-

DYNAMIC SCREWS			
DYNAMIC SCREW	HIGH DYNAMIC SCREW	DYNAMIC SCREWDRIVER	SCREWDRIVER LENGTH (mm)
41.320.044.01-2	-	43.618.201.01-2	18
		43.624.201.01-2	24
		43.632.201.01-2	32

STRAIGHT SCREWS		
STRAIGHT SCREW	ANALOG	LAB SCANBODY
40.320.003.05-2	-	30.413.002.01-2

LIBRARY OPTIONS
GH = Gingival Height α_s - Standard maximum angulation
CH = Cement Height α_c - Captive maximum angulation
IG = Adaptor 3mm α_{di} - Direct to implant maximum angulation
R = Rotational / Non-Engaging
NR = Non Rotational / Engaging

STANDARD DYNAMIC TIBASE															
	GINGIVAL HEIGHT	α_s	α_c	GINGIVAL HEIGHT	α_s	α_c	GINGIVAL HEIGHT	α_s	α_c	GINGIVAL HEIGHT	α_s	α_c	GINGIVAL HEIGHT	α_s	α_c
	0.3 mm			mm			mm			mm			mm		
R	31.325.129.01-2	43°	30°	-	-	-	-	-	-	-	-	-	-	-	-
NR	31.315.129.01-2			-	-	-	-	-	-	-	-	-	-	-	-

DYNAMIC 3TIBASE

	GINGIVAL HEIGHT	α_s	α_c	α_s
		CH-5mm	CH- 7mm	CH- 9mm
R	-	-	-	-
NR	-	-	-	-

DYNAMIC SCANBODY (LAB/CLIN)				DIGITAL ANALOG
SCANBODY	HEIGHT mm	ADAPTOR	SCREWDRIVER ADAPTOR	DIGITAL ANALOG
52.410.130.01-2	10	50.315.129.01-2	43.621.410.01-2 43.624.410.01-2	34.615.129.01-2
-	-			
-	-			

DYNAMIC MILLING TOOL		
DYNAMIC MILLING TOOL	SHANK	α_{di}
33.390.958.01-2	3	30°
33.490.958.01-2	4	
33.690.958.01-2	6	

DYNAMIC SCREWS			
DYNAMIC SCREW	HIGH DYNAMIC SCREW	DYNAMIC SCREWDRIVER	SCREWDRIVER LENGTH (mm)
41.320.090.01-2	-	43.618.201.01-2	18
		43.624.201.01-2	24
		43.632.201.01-2	32

STRAIGHT SCREWS		ANALOG	LAB SCANBODY
STRAIGHT SCREW	SCREWDRIVER UNIGRIP		
40.320.008.03-2	43.601.108.01-2	-	30.415.007.01-2

LIBRARY OPTIONS
GH = Gingival Height α_s - Standard maximum angulation
CH = Cement Height α_c - Captive maximum angulation
IG = Adaptor 3mm α_{di} - Direct to implant maximum angulation
R = Rotational / Non-Engaging
NR = Non Rotational / Engaging

STANDARD DYNAMIC TIBASE															
	GINGIVAL HEIGHT	α_s	α_c	GINGIVAL HEIGHT	α_s	α_c	GINGIVAL HEIGHT	α_s	α_c	GINGIVAL HEIGHT	α_s	α_c	GINGIVAL HEIGHT	α_s	α_c
	0.5 mm			mm			mm			mm			mm		
R	31.322.130.01-2	30°	29°	-	-	-	-	-	-	-	-	-	-	-	-
NR	31.312.130.01-2			-	-	-	-	-	-	-	-	-	-	-	-

DYNAMIC 3TIBASE				
	GINGIVAL HEIGHT	α_s	α_s	α_s
		CH+ 5mm	CH+ 7mm	CH+ 9mm
R	-	-	-	-
NR	-	-	-	-

DYNAMIC SCANBODY (LAB/CLIN)				DIGITAL ANALOG
SCANBODY	HEIGHT mm	ADAPTOR	SCREWDRIVER ADAPTOR	DIGITAL ANALOG
-	-	-	-	-
-	-	-	-	-
-	-	-	-	-

DYNAMIC MILLING TOOL		
DYNAMIC MILLING TOOL	SHANK	α_{di}
-	-	-
-	-	-
-	-	-

DYNAMIC SCREWS			
DYNAMIC SCREW	HIGH DYNAMIC SCREW	DYNAMIC SCREWDRIVER	SCREWDRIVER LENGTH (mm)
41.316.081.01-2	-	43.618.201.01-2	18
		43.624.201.01-2	24
		43.632.201.01-2	32

STRAIGHT SCREWS	
STRAIGHT SCREW	SCREWDRIVER Hex. 1.27
40.316.005.08-2	43.601.105.01-2

ANALOG	LAB SCANBODY
-	30.412.001.01-2

LIBRARY OPTIONS
GH = Gingival Height α_s - Standard maximum angulation
CH = Cement Height α_c - Captive maximum angulation
IG = Adaptor 3mm α_{di} - Direct to implant maximum angulation
R = Rotational / Non-Engaging
NR = Non Rotational / Engaging

STANDARD DYNAMIC TIBASE															
	GINGIVAL HEIGHT	α_s	α_c	GINGIVAL HEIGHT	α_s	α_c	GINGIVAL HEIGHT	α_s	α_c	GINGIVAL HEIGHT	α_s	α_c	GINGIVAL HEIGHT	α_s	α_c
	0.5 mm			mm			mm			mm			mm		
R	31.323.131.01-2	45°	29°	-	-	-	-	-	-	-	-	-	-	-	-
NR	31.313.131.01-2			-	-	-	-	-	-	-	-	-	-	-	-

DYNAMIC 3TIBASE				
	GINGIVAL HEIGHT	α_s	α_s	α_s
		CH+ 5mm	CH+ 7mm	CH+ 9mm
R	-	-	-	-
NR	-	-	-	-

DYNAMIC SCANBODY (LAB/CLIN)				DIGITAL ANALOG
SCANBODY	HEIGHT mm	ADAPTOR	SCREWDRIVER ADAPTOR	DIGITAL ANALOG
-	-	-	-	-
-	-	-	-	-
-	-	-	-	-

DYNAMIC MILLING TOOL		
DYNAMIC MILLING TOOL	SHANK	α_{di}
-	-	-
-	-	-
-	-	-

DYNAMIC SCREWS			
DYNAMIC SCREW	HIGH DYNAMIC SCREW	DYNAMIC SCREWDRIVER	SCREWDRIVER LENGTH (mm)
41.316.081.01-2	-	43.618.201.01-2	18
		43.624.201.01-2	24
		43.632.201.01-2	32

STRAIGHT SCREWS	
STRAIGHT SCREW	SCREWDRIVER Hex. 1.27
40.316.005.08-2	43.601.105.01-2

ANALOG	LAB SCANBODY
-	30.413.002.01-2

LIBRARY OPTIONS
GH = Gingival Height α_s - Standard maximum angulation
CH = Cement Height α_c - Captive maximum angulation
IG = Adaptor 3mm α_{di} - Direct to implant maximum angulation
R = Rotational / Non-Engaging
NR = Non Rotational / Engaging

STANDARD DYNAMIC TIBASE															
	GINGIVAL HEIGHT	α_s	α_c	GINGIVAL HEIGHT	α_s	α_c	GINGIVAL HEIGHT	α_s	α_c	GINGIVAL HEIGHT	α_s	α_c	GINGIVAL HEIGHT	α_s	α_c
	0.5 mm			mm			mm			mm			mm		
R	31.324.132.01-2	45°	28°	-	-	-	-	-	-	-	-	-	-	-	-
NR	31.314.132.01-2			-	-	-	-	-	-	-	-	-	-	-	-

DYNAMIC 3TIBASE				
	GINGIVAL HEIGHT	α_s	α_s	α_s
		CH+5mm	CH+7mm	CH+9mm
R	-	-	-	-
NR	-	-	-	-

DYNAMIC SCANBODY (LAB/CLIN)				DIGITAL ANALOG
SCANBODY	HEIGHT mm	ADAPTOR	SCREWDRIVER ADAPTOR	DIGITAL ANALOG
-	-	-	-	-
-	-	-	-	-
-	-	-	-	-

DYNAMIC MILLING TOOL		
DYNAMIC MILLING TOOL	SHANK	α_{di}
-	-	-
-	-	-
-	-	-

DYNAMIC SCREWS			
DYNAMIC SCREW	HIGH DYNAMIC SCREW	DYNAMIC SCREWDRIVER	SCREWDRIVER LENGTH (mm)
41.316.081.01-2	-	43.618.201.01-2	18
		43.624.201.01-2	24
		43.632.201.01-2	32

STRAIGHT SCREWS	
STRAIGHT SCREW	SCREWDRIVER Hex. 1.27
40.316.005.08-2	43.601.105.01-2

ANALOG	LAB SCANBODY
-	30.414.003.01-2

LIBRARY OPTIONS
GH = Gingival Height α_s - Standard maximum angulation
CH = Cement Height α_c - Captive maximum angulation
IG = Adaptor 3mm α_s - Direct to implant maximum angulation
R = Rotational / Non-Engaging
NR = Non Rotational / Engaging

STANDARD DYNAMIC TIBASE															
	GINGIVAL HEIGHT	α_s	α_c	GINGIVAL HEIGHT	α_s	α_c	GINGIVAL HEIGHT	α_s	α_c	GINGIVAL HEIGHT	α_s	α_c	GINGIVAL HEIGHT	α_s	α_c
	1 mm			mm			mm			mm			mm		
R	31.320.135.01-2	45°	-	-	-	-	-	-	-	-	-	-	-	-	-
NR	31.310.135.01-2			-	-	-	-	-	-	-	-	-	-	-	-

DYNAMIC 3TIBASE				
	GINGIVAL HEIGHT	α_s	α_s	α_s
		CH+5mm	CH+7mm	CH+9mm
R	-	-	-	-
NR	-	-	-	-

DYNAMIC SCANBODY (LAB/CLIN)				DIGITAL ANALOG
SCANBODY	HEIGHT mm	ADAPTOR	SCREWDRIVER ADAPTOR	DIGITAL ANALOG
-	-	-	-	-
-	-	-	-	-
-	-	-	-	-

DYNAMIC MILLING TOOL		
DYNAMIC MILLING TOOL	SHANK	α_{di}
-	-	-
-	-	-
-	-	-

SCANBODY OP		
SCANBODY	PEEK PINS	mm
54.315.135.21-2	49.414.000.01-2	6
	49.415.000.01-2	9
	49.416.000.01-2	13

SCREWDRIVER 43.601.107.01-2

DYNAMIC SCREWS			
DYNAMIC SCREW	HIGH DYNAMIC SCREW	DYNAMIC SCREWDRIVER	SCREWDRIVER LENGTH (mm)
41.314.080.01-2	-	43.618.201.01-2	18
		43.624.201.01-2	24
		43.632.201.01-2	32

STRAIGHT SCREWS	
STRAIGHT SCREW	SCREWDRIVER TORX T6
40.314.007.02-2	43.601.107.01-2

ANALOG	LAB SCANBODY
-	30.410.006.01-2

LIBRARY OPTIONS
GH = Gingival Height α_s - Standard maximum angulation
CH = Cement Height α_c - Captive maximum angulation
IG = Adaptor 3mm α_s - Direct to implant maximum angulation
R = Rotational / Non-Engaging
NR = Non Rotational / Engaging

STANDARD DYNAMIC TIBASE															
	GINGIVAL HEIGHT	α_s	α_c	GINGIVAL HEIGHT	α_s	α_c	GINGIVAL HEIGHT	α_s	α_c	GINGIVAL HEIGHT	α_s	α_c	GINGIVAL HEIGHT	α_s	α_c
	0,7 mm			1,5 mm			mm			3 mm			4 mm		
	0,7 mm			1,5 mm			mm			3 mm			4 mm		
R	31.320.136.01-2	45°	30°	31.320.136.02-2	25°	-	-	-	-	31.320.136.04-2	20°	-	31.320.136.05-2	20°	-
NR	31.310.136.01-2			31.310.136.02-2						31.310.136.04-2			31.310.136.05-2		
													31.320.136.06-2	15°	-
													31.310.136.06-2		

DYNAMIC 3TIBASE				
GINGIVAL HEIGHT	α_s	α_c	α_s	α_s
	CH-5mm	CH-7mm	CH-9mm	
-	-	-	-	-
-	-	-	-	-

DYNAMIC SCANBODY (LAB/CLIN)				DIGITAL ANALOG
SCANBODY	HEIGHT mm	ADAPTOR	SCREWDRIVER ADAPTOR	DIGITAL ANALOG
52.410.128.01-2	10	50.310.136.01-2	43.621.415.01-2	34.610.136.01-2
		50.310.136.04-2 <small>IG-3mm</small>		
52.412.128.01-2	12			

DYNAMIC MILLING TOOL		
DYNAMIC MILLING TOOL	SHANK	α_{di}
33.360.754.01-2	3	25°
33.460.754.01-2	4	
33.660.754.01-2	6	

DYNAMIC SCREWS			
DYNAMIC SCREW	HIGH DYNAMIC SCREW	DYNAMIC SCREWDRIVER	SCREWDRIVER LENGTH (mm)
41.316.071.01-2	-	43.618.201.01-2	18
		43.624.201.01-2	24
		43.632.201.01-2	32

STRAIGHT SCREWS	
STRAIGHT SCREW	SCREWDRIVER Hex. 1.25
40.316.004.03-2	43.601.104.01-2

ANALOG	LAB SCANBODY
-	30.410.006.01-2

MULTI-UNIT				
	GINGIVAL HEIGHT	GINGIVAL HEIGHT	GINGIVAL HEIGHT	GINGIVAL HEIGHT
	1 mm	2 mm	3 mm	4 mm
R	42.300.136.01-2	42.300.136.02-2	42.300.136.3-2	42.300.136.04-2

LIBRARY OPTIONS

GH = Gingival Height α_s - Standard maximum angulation
CH = Cement Height α_c - Captive maximum angulation
IG = Adaptor 3mm α_d - Direct to implant maximum angulation
R = Rotational / Non-Engaging
NR = Non Rotational / Engaging

STANDARD DYNAMIC TIBASE															
	GINGIVAL HEIGHT	α_s	α_c	GINGIVAL HEIGHT	α_s	α_c	GINGIVAL HEIGHT	α_s	α_c	GINGIVAL HEIGHT	α_s	α_c	GINGIVAL HEIGHT	α_s	α_c
	0,6 mm			mm			mm			mm			mm		
	0,6 mm			mm			mm			mm			mm		
R	31.324.137.01-2	45°	30°	-	-	-	-	-	-	-	-	-	-	-	-
NR	31.314.137.01-2			-			-			-			-		

DYNAMIC 3TIBASE				
GINGIVAL HEIGHT	α_s	α_c	α_s	α_s
	CH-5mm	CH-7mm	CH-9mm	
-	-	-	-	-
-	-	-	-	-

DYNAMIC SCANBODY (LAB/CLIN)				DIGITAL ANALOG
SCANBODY	HEIGHT mm	ADAPTOR	SCREWDRIVER ADAPTOR	DIGITAL ANALOG
-	-	-	-	-
-	-			
-	-			

DYNAMIC MILLING TOOL		
DYNAMIC MILLING TOOL	SHANK	α_{di}
-	-	-
-	-	
-	-	

DYNAMIC SCREWS			
DYNAMIC SCREW	HIGH DYNAMIC SCREW	DYNAMIC SCREWDRIVER	SCREWDRIVER LENGTH (mm)
41.320.044.01-2	-	43.618.201.01-2	18
		43.624.201.01-2	24
		43.632.201.01-2	32

STRAIGHT SCREWS	
STRAIGHT SCREW	SCREWDRIVER TORX T6
40.320.007.04-2	43.601.107.01-2

ANALOG	LAB SCANBODY
-	30.414.008.01-2

LIBRARY OPTIONS

GH = Gingival Height α_s - Standard maximum angulation
CH = Cement Height α_c - Captive maximum angulation
IG = Adaptor 3mm α_d - Direct to implant maximum angulation
R = Rotational / Non-Engaging
NR = Non Rotational / Engaging

STANDARD DYNAMIC TIBASE															
	GINGIVAL HEIGHT	α_s	α_c	GINGIVAL HEIGHT	α_s	α_c	GINGIVAL HEIGHT	α_s	α_c	GINGIVAL HEIGHT	α_s	α_c	GINGIVAL HEIGHT	α_s	α_c
	1.5 mm			mm			mm			3 mm			mm		
R	31.320.145.01-2	45°	-	-	-	-	-	-	-	-	-	-	-	-	-
NR	31.310.145.01-2			-			-			-			-		

DYNAMIC 3TIBASE				
GINGIVAL HEIGHT	α_s	α_c	α_s	α_s
	CH+5mm	CH+7mm	CH+9mm	
-	-	-	-	-
-	-	-	-	-

DYNAMIC SCANBODY (LAB/CLIN)				DIGITAL ANALOG
SCANBODY	HEIGHT mm	ADAPTOR	SCREWDRIVER ADAPTOR	DIGITAL ANALOG
-	-	-	-	-
-	-			
-	-	-	-	-

DYNAMIC MILLING TOOL		
DYNAMIC MILLING TOOL	SHANK	α_{di}
-	-	-
-	-	
-	-	

DYNAMIC SCREWS			
DYNAMIC SCREW	HIGH DYNAMIC SCREW	DYNAMIC SCREWDRIVER	SCREWDRIVER LENGTH (mm)
41.315.078.01-2	-	43.618.201.01-2	18
		43.624.201.01-2	24
		43.632.201.01-2	32

STRAIGHT SCREWS	
STRAIGHT SCREW	SCREWDRIVER
-	-

ANALOG	LAB SCANBODY
-	30.410.006.01-2

LIBRARY OPTIONS
GH = Gingival Height α_s - Standard maximum angulation
CH = Cement Height α_c - Captive maximum angulation
IG = Adaptor 3mm α_s - Direct to implant maximum angulation
R = Rotational / Non-Engaging
NR = Non Rotational / Engaging

STANDARD DYNAMIC TIBASE															
	GINGIVAL HEIGHT	α_s	α_c	GINGIVAL HEIGHT	α_s	α_c	GINGIVAL HEIGHT	α_s	α_c	GINGIVAL HEIGHT	α_s	α_c	GINGIVAL HEIGHT	α_s	α_c
	1.5 mm			mm			mm			mm			mm		
R	31.323.149.01-2	45°	29°	-	-	-	-	-	-	-	-	-	-	-	-
NR	31.313.149.01-2			-			-			-			-		

DYNAMIC 3TIBASE				
GINGIVAL HEIGHT	α_s	α_c	α_s	α_s
	CH+5mm	CH+7mm	CH+9mm	
-	-	-	-	-
-	-	-	-	-

DYNAMIC SCANBODY (LAB/CLIN)				DIGITAL ANALOG
SCANBODY	HEIGHT mm	ADAPTOR	SCREWDRIVER ADAPTOR	DIGITAL ANALOG
52.410.132.01-2	10	50.310.161.01-2	43.621.415.01-2	34.610.161.01-2
-	-			
52.412.132.01-2	12	-	-	-

DYNAMIC MILLING TOOL		
DYNAMIC MILLING TOOL	SHANK	α_{di}
33.320.704.01-2*	3	25°
33.420.704.01-2*	4	
33.620.704.01-2*	6	

*Only for R

DYNAMIC SCREWS			
DYNAMIC SCREW	HIGH DYNAMIC SCREW	DYNAMIC SCREWDRIVER	SCREWDRIVER LENGTH (mm)
41.316.079.01-2	-	43.618.201.01-2	18
		43.624.201.01-2	24
		43.632.201.01-2	32

STRAIGHT SCREWS	
STRAIGHT SCREW	SCREWDRIVER
40.316.014.01-2	-

ANALOG	LAB SCANBODY
-	30.413.002.01-2

LIBRARY OPTIONS
GH = Gingival Height α_s - Standard maximum angulation
CH = Cement Height α_c - Captive maximum angulation
IG = Adaptor 3mm α_s - Direct to implant maximum angulation
R = Rotational / Non-Engaging
NR = Non Rotational / Engaging

STANDARD DYNAMIC TIBASE															
	GINGIVAL HEIGHT	α_s	α_c	GINGIVAL HEIGHT	α_s	α_c	GINGIVAL HEIGHT	α_s	α_c	GINGIVAL HEIGHT	α_s	α_c	GINGIVAL HEIGHT	α_s	α_c
	0.5 mm			mm			mm			mm			mm		
R	31.323.150.01-2	45°	-	-	-	-	-	-	-	-	-	-	-	-	-
NR	-			-	-	-	-	-	-	-	-	-	-	-	-

DYNAMIC 3TIBASE				
GINGIVAL HEIGHT	α_s	α_c	α_s	α_s
	CH-5mm	CH-7mm	CH-9mm	
-	-	-	-	-
-	-	-	-	-

DYNAMIC SCANBODY (LAB/CLIN)				DIGITAL ANALOG
SCANBODY	HEIGHT mm	ADAPTOR	SCREWDRIVER ADAPTOR	DIGITAL ANALOG
-	-	-	-	-
-	-	-	-	-
-	-	-	-	-

DYNAMIC MILLING TOOL		
DYNAMIC MILLING TOOL	SHANK	α_{di}
-	-	-
-	-	-
-	-	-

DYNAMIC SCREWS			
DYNAMIC SCREW	HIGH DYNAMIC SCREW	DYNAMIC SCREWDRIVER	SCREWDRIVER LENGTH (mm)
41.314.046.01-2	-	43.618.201.01-2	18
		43.624.201.01-2	24
		43.632.201.01-2	32

STRAIGHT SCREWS	
STRAIGHT SCREW	SCREWDRIVER Hex. 1.25
40.314.004.04-2	43.601.104.01-2

ANALOG	LAB SCANBODY
-	30.413.005.01-2

LIBRARY OPTIONS
GH = Gingival Height α_s - Standard maximum angulation
CH = Cement Height α_c - Captive maximum angulation
IG = Adaptor 3mm α_s - Direct to implant maximum angulation
R = Rotational / Non-Engaging
NR = Non Rotational / Engaging

STANDARD DYNAMIC TIBASE															
	GINGIVAL HEIGHT	α_s	α_c	GINGIVAL HEIGHT	α_s	α_c	GINGIVAL HEIGHT	α_s	α_c	GINGIVAL HEIGHT	α_s	α_c	GINGIVAL HEIGHT	α_s	α_c
	0.3 mm			mm			mm			mm			mm		
R	31.323.151.01-2	45°	30°	-	-	-	-	-	-	-	-	-	-	-	-
-	-			-	-	-	-	-	-	-	-	-	-	-	-

DYNAMIC 3TIBASE				
GINGIVAL HEIGHT	α_s	α_c	α_s	α_s
	CH-5mm	CH-7mm	CH-9mm	
-	-	-	-	-
-	-	-	-	-

DYNAMIC SCANBODY (LAB/CLIN)				DIGITAL ANALOG
SCANBODY	HEIGHT mm	ADAPTOR	SCREWDRIVER ADAPTOR	DIGITAL ANALOG
52.409.123.01-2	9	50.313.151.01-2	43.621.410.01-2 43.624.410.01-2	34.613.151.01-2

DYNAMIC MILLING TOOL		
DYNAMIC MILLING TOOL	SHANK	α_{di}
33.390.716.01-2	3	30°
33.490.716.01-2	4	
33.690.716.01-2	6	

DYNAMIC SCREWS			
DYNAMIC SCREW	HIGH DYNAMIC SCREW	DYNAMIC SCREWDRIVER	SCREWDRIVER LENGTH (mm)
41.314.039.01-2	-	43.618.201.01-2	18
		43.624.201.01-2	24
		43.632.201.01-2	32

STRAIGHT SCREWS	
STRAIGHT SCREW	SCREWDRIVER Unigrip
40.314.008.01-2	43.601.108.01-2

ANALOG	LAB SCANBODY
-	-

LIBRARY OPTIONS
GH = Gingival Height α_s - Standard maximum angulation
CH = Cement Height α_c - Captive maximum angulation
IG = Adaptor 3mm α_s - Direct to implant maximum angulation
R = Rotational / Non-Engaging
NR = Non Rotational / Engaging

STANDARD DYNAMIC TIBASE															
	GINGIVAL HEIGHT	α_s	α_c	GINGIVAL HEIGHT	α_s	α_c	GINGIVAL HEIGHT	α_s	α_c	GINGIVAL HEIGHT	α_s	α_c	GINGIVAL HEIGHT	α_s	α_c
	1 mm			2 mm			3 mm			4 mm			mm		
R	31.320.152.01-2	45°	-	31.320.152.02-2	25°	-	31.320.152.03-2	20°	-	31.320.152.04-2	20°	-	-	-	-
NR	31.310.152.01-2			31.310.152.02-2			31.310.152.03-2			31.310.152.04-2			-	-	-

DYNAMIC 3TIBASE				
	GINGIVAL HEIGHT	α_s	α_c	α_s
		CH-5mm	CH-7mm	CH-9mm
-	-	-	-	-
-	-	-	-	-

DYNAMIC SCANBODY (LAB/CLIN)				DIGITAL ANALOG
SCANBODY	HEIGHT mm	ADAPTOR	SCREWDRIVER ADAPTOR	DIGITAL ANALOG
52.410.104.01-2	10	50.310.152.03-2 IG-3mm	43.621.410.01-2 43.624.410.01-2	34.610.152.01-2
52.412.104.01-2	12			

DYNAMIC MILLING TOOL		
DYNAMIC MILLING TOOL	SHANK	α_{di}
33.360.756.01-2	3	25°
33.460.756.01-2	4	
33.660.756.01-2	6	

*Only for R

DYNAMIC SCREWS			
DYNAMIC SCREW	HIGH DYNAMIC SCREW	DYNAMIC SCREWDRIVER	SCREWDRIVER LENGTH (mm)
41.318.077.02-2	-	43.618.201.01-2	18
		43.624.201.01-2	24
		43.632.201.01-2	32

STRAIGHT SCREWS	
STRAIGHT SCREW	SCREWDRIVER
-	-

ANALOG	LAB SCANBODY
-	30.410.006.01-2

MULTI-UNIT				
	GINGIVAL HEIGHT	GINGIVAL HEIGHT	GINGIVAL HEIGHT	GINGIVAL HEIGHT
	1 mm	2 mm	3 mm	4 mm
R	-	42.300.152.02-2	42.300.152.03-2	-

LIBRARY OPTIONS
GH = Gingival Height α_s - Standard maximum angulation
CH = Cement Height α_c - Captive maximum angulation
IG = Adaptor 3mm α_{di} - Direct to implant maximum angulation
R = Rotational / Non-Engaging
NR = Non Rotational / Engaging

STANDARD DYNAMIC TIBASE															
	GINGIVAL HEIGHT	α_s	α_c	GINGIVAL HEIGHT	α_s	α_c	GINGIVAL HEIGHT	α_s	α_c	GINGIVAL HEIGHT	α_s	α_c	GINGIVAL HEIGHT	α_s	α_c
	1.5 mm			mm			mm			mm			mm		
R	31.320.159.01-2	41°	17°	-	-	-	-	-	-	-	-	-	-	-	-
NR	31.310.159.01-2			-	-	-	-	-	-	-	-	-	-	-	-

DYNAMIC 3TIBASE				
	GINGIVAL HEIGHT	α_s	α_c	α_s
		CH-5mm	CH-7mm	CH-9mm
-	-	-	-	-
-	-	-	-	-

DYNAMIC SCANBODY (LAB/CLIN)				DIGITAL ANALOG
SCANBODY	HEIGHT mm	ADAPTOR	SCREWDRIVER ADAPTOR	DIGITAL ANALOG
52.410.128.01-2	10	50.310.159.01-2	43.621.415.01-2	34.610.159.01-2
-	-			

DYNAMIC MILLING TOOL		
DYNAMIC MILLING TOOL	SHANK	α_{di}
33.335.754.01-2*	3	25°
33.435.754.01-2*	4	
33.635.754.01-2*	6	

*Only for R

DYNAMIC SCREWS			
DYNAMIC SCREW	HIGH DYNAMIC SCREW	DYNAMIC SCREWDRIVER	SCREWDRIVER LENGTH (mm)
41.314.067.02-2	-	43.618.201.01-2	18
		43.624.201.01-2	24
		43.632.201.01-2	32

STRAIGHT SCREWS	
STRAIGHT SCREW	SCREWDRIVER UNIGRIP
40.314.008.02-2	43.601.108.01-2

ANALOG	LAB SCANBODY
22.610.159.01-2	30.410.006.01-2

MULTI-UNIT				
	GINGIVAL HEIGHT	GINGIVAL HEIGHT	GINGIVAL HEIGHT	GINGIVAL HEIGHT
	1 mm	2 mm	3 mm	4 mm
R	42.300.159.01-2	42.300.159.02-2	42.300.159.03-2	42.300.159.04-2

LIBRARY OPTIONS
GH = Gingival Height α_s - Standard maximum angulation
CH = Cement Height α_c - Captive maximum angulation
IG = Adaptor 3mm α_{di} - Direct to implant maximum angulation
R = Rotational / Non-Engaging
NR = Non Rotational / Engaging

STANDARD DYNAMIC TIBASE															
	GINGIVAL HEIGHT	α_s	α_c	GINGIVAL HEIGHT	α_s	α_c	GINGIVAL HEIGHT	α_s	α_c	GINGIVAL HEIGHT	α_s	α_c	GINGIVAL HEIGHT	α_s	α_c
	0.5 mm			mm			mm			mm			mm		
R	31.320.160.01-2	45°	30°	-	-	-	-	-	-	-	-	-	-	-	-
NR	31.310.160.01-2			-	-	-	-	-	-	-	-	-	-	-	-

DYNAMIC 3TIBASE				
GINGIVAL HEIGHT	α_s	α_s	α_s	
	CH-5mm	CH-7mm	CH-9mm	
-	-	-	-	-
-	-	-	-	-

DYNAMIC SCANBODY (LAB/CLIN)				DIGITAL ANALOG
SCANBODY	HEIGHT mm	ADAPTOR	SCREWDRIVER ADAPTOR	DIGITAL ANALOG
52.410.131.01-2	10	50.310.160.01-2	43.621.415.01-2	34.610.160.01-2
52.412.131.01-2	12			

DYNAMIC MILLING TOOL		
DYNAMIC MILLING TOOL	SHANK	α_{di}
33.315.804.01-2	3	25°
33.415.804.01-2	4	
33.615.804.01-2	6	

SCANALOG
23.410.160.01-2

DYNAMIC SCREWS			
DYNAMIC SCREW	HIGH DYNAMIC SCREW	DYNAMIC SCREWDRIVER	SCREWDRIVER LENGTH (mm)
41.316.078.01-2	-	43.618.201.01-2	18
		43.624.201.01-2	24
		43.632.201.01-2	32

STRAIGHT SCREWS	
STRAIGHT SCREW	SCREWDRIVER TORX T6
40.316.007.01-2	43.601.107.01-2

LAB SCANBODY
30.410.006.01-2

LIBRARY OPTIONS
GH = Gingival Height α_s - Standard maximum angulation
CH = Cement Height α_c - Captive maximum angulation
IG = Adaptor 3mm α_{di} - Direct to implant maximum angulation
R = Rotational / Non-Engaging
NR = Non Rotational / Engaging

STANDARD DYNAMIC TIBASE															
	GINGIVAL HEIGHT	α_s	α_c	GINGIVAL HEIGHT	α_s	α_c	GINGIVAL HEIGHT	α_s	α_c	GINGIVAL HEIGHT	α_s	α_c	GINGIVAL HEIGHT	α_s	α_c
	1.5 mm			mm			mm			mm			mm		
R	31.320.161.01-2	45°	25°	-	-	-	-	-	-	-	-	-	-	-	-
NR	31.310.161.01-2			-	-	-	-	-	-	-	-	-	-	-	-

DYNAMIC 3TIBASE				
GINGIVAL HEIGHT	α_s	α_s	α_s	
	CH-5mm	CH-7mm	CH-9mm	
-	-	-	-	-
-	-	-	-	-

DYNAMIC SCANBODY (LAB/CLIN)				DIGITAL ANALOG
SCANBODY	HEIGHT mm	ADAPTOR	SCREWDRIVER ADAPTOR	DIGITAL ANALOG
52.410.132.01-2	10	50.310.161.01-2	43.621.415.01-2	34.610.161.01-2
52.412.132.01-2	12			

DYNAMIC MILLING TOOL		
DYNAMIC MILLING TOOL	SHANK	α_{di}
33.320.704.01-2*	3	25°
33.420.704.01-2*	4	
33.620.704.01-2*	6	

*Only for R

DYNAMIC SCREWS			
DYNAMIC SCREW	HIGH DYNAMIC SCREW	DYNAMIC SCREWDRIVER	SCREWDRIVER LENGTH (mm)
41.316.079.01-2	-	43.618.201.01-2	18
		43.624.201.01-2	24
		43.632.201.01-2	32

STRAIGHT SCREWS	
STRAIGHT SCREW	SCREWDRIVER
40.316.014.01-2	-

ANALOG	LAB SCANBODY
-	30.410.006.01-2

LIBRARY OPTIONS
GH = Gingival Height α_s - Standard maximum angulation
CH = Cement Height α_c - Captive maximum angulation
IG = Adaptor 3mm α_{di} - Direct to implant maximum angulation
R = Rotational / Non-Engaging
NR = Non Rotational / Engaging

STANDARD DYNAMIC TIBASE															
	GINGIVAL HEIGHT	α_s	α_c	GINGIVAL HEIGHT	α_s	α_c	GINGIVAL HEIGHT	α_s	α_c	GINGIVAL HEIGHT	α_s	α_c	GINGIVAL HEIGHT	α_s	α_c
	1.5 mm			mm			mm			mm			mm		
R	31.324.162.01-2	45°	24°	-	-	-	-	-	-	-	-	-	-	-	-
NR	31.314.162.01-2			-	-	-	-	-	-	-	-	-	-	-	-

DYNAMIC 3TIBASE				
GINGIVAL HEIGHT	α_s	α_c	α_s	α_s
	CH-5mm	CH-7mm	CH-9mm	
-	-	-	-	-
-	-	-	-	-

DYNAMIC SCANBODY (LAB/CLIN)				DIGITAL ANALOG
SCANBODY	HEIGHT mm	ADAPTOR	SCREWDRIVER ADAPTOR	DIGITAL ANALOG
52.410.132.01-2	10	50.310.161.01-2	43.621.415.01-2	34.610.161.01-2
52.412.132.01-2	12			

DYNAMIC MILLING TOOL		
DYNAMIC MILLING TOOL	SHANK	α_{di}
33.320.704.01-2*	3	25°
33.420.704.01-2*	4	
33.620.704.01-2*	6	

*Only for R

DYNAMIC SCREWS			
DYNAMIC SCREW	HIGH DYNAMIC SCREW	DYNAMIC SCREWDRIVER	SCREWDRIVER LENGTH (mm)
41.316.079.01-2	-	43.618.201.01-2	18
		43.624.201.01-2	24
		43.632.201.01-2	32

STRAIGHT SCREWS	
STRAIGHT SCREW	SCREWDRIVER
40.316.014.01-2	-

ANALOG	LAB SCANBODY
-	30.414.003.01-2

LIBRARY OPTIONS

- GH** = Gingival Height α_s - Standard maximum angulation
- CH** = Cement Height α_c - Captive maximum angulation
- IG** = Adaptor 3mm α_s - Direct to implant maximum angulation
- R** = Rotational / Non-Engaging
- NR** = Non Rotational / Engaging

STANDARD DYNAMIC TIBASE															
	GINGIVAL HEIGHT	α_s	α_c	GINGIVAL HEIGHT	α_s	α_c	GINGIVAL HEIGHT	α_s	α_c	GINGIVAL HEIGHT	α_s	α_c	GINGIVAL HEIGHT	α_s	α_c
	0.5 mm			mm			mm			mm			mm		
R	31.323.163.01-2	45°	30°	-	-	-	-	-	-	-	-	-	-	-	-
NR	-			-	-	-	-	-	-	-	-	-	-	-	-

DYNAMIC 3TIBASE				
GINGIVAL HEIGHT	α_s	α_c	α_s	α_s
	CH-5mm	CH-7mm	CH-9mm	
-	-	-	-	-
-	-	-	-	-

DYNAMIC SCANBODY (LAB/CLIN)				DIGITAL ANALOG
SCANBODY	HEIGHT mm	ADAPTOR	SCREWDRIVER ADAPTOR	DIGITAL ANALOG
52.408.112.01-2	8	50.313.163.01-2	43.620.411.01-2	34.613.163.01-2

DYNAMIC MILLING TOOL		
DYNAMIC MILLING TOOL	SHANK	α_{di}
33.390.716.01-2	3	30°
33.490.716.01-2	4	
33.690.716.01-2	6	

DYNAMIC SCREWS			
DYNAMIC SCREW	HIGH DYNAMIC SCREW	DYNAMIC SCREWDRIVER	SCREWDRIVER LENGTH (mm)
41.314.039.01-2	-	43.618.201.01-2	18
		43.624.201.01-2	24
		43.632.201.01-2	32

STRAIGHT SCREWS	
STRAIGHT SCREW	SCREWDRIVER
40.314.014.01-2	-

ANALOG	LAB SCANBODY
-	30.413.005.01-2

LIBRARY OPTIONS

- GH** = Gingival Height α_s - Standard maximum angulation
- CH** = Cement Height α_c - Captive maximum angulation
- IG** = Adaptor 3mm α_s - Direct to implant maximum angulation
- R** = Rotational / Non-Engaging
- NR** = Non Rotational / Engaging

STANDARD DYNAMIC TIBASE															
	GINGIVAL HEIGHT	α_s	α_c	GINGIVAL HEIGHT	α_s	α_c	GINGIVAL HEIGHT	α_s	α_c	GINGIVAL HEIGHT	α_s	α_c	GINGIVAL HEIGHT	α_s	α_c
	1.5 mm			mm			mm			mm			mm		
R	31.320.164.01-2	45°	21°	-	-	-	-	-	-	-	-	-	-	-	-
NR	31.310.164.01-2			-	-	-	-	-	-	-	-	-	-	-	-

DYNAMIC 3TIBASE				
GINGIVAL HEIGHT	α_s	α_s	α_s	
	CH-5mm	CH-7mm	CH-9mm	
-	-	-	-	-
-	-	-	-	-

DYNAMIC SCANBODY (LAB/CLIN)				DIGITAL ANALOG
SCANBODY	HEIGHT mm	ADAPTOR	SCREWDRIVER ADAPTOR	DIGITAL ANALOG
52.410.128.01-2	10	50.310.164.01-2	43.621.415.01-2	34.610.164.01-2
52.412.128.01-2	12			

DYNAMIC MILLING TOOL		
DYNAMIC MILLING TOOL	SHANK	α_{di}
33.345.804.01-2*	3	25°
33.445.804.01-2*	4	
33.645.804.01-2*	6	

*Only for R

DYNAMIC SCREWS			
DYNAMIC SCREW	HIGH DYNAMIC SCREW	DYNAMIC SCREWDRIVER	SCREWDRIVER LENGTH (mm)
41.312.078.01-2	-	43.618.201.01-2	18
		43.624.201.01-2	24
		43.632.201.01-2	32

STRAIGHT SCREWS	
STRAIGHT SCREW	SCREWDRIVER Hex. 1,20
40.312.003.01-2	43.601.103.02-2

ANALOG	LAB SCANBODY
-	30.410.006.01-2

LIBRARY OPTIONS
GH = Gingival Height α_s - Standard maximum angulation
CH = Cement Height α_c - Captive maximum angulation
IG = Adaptor 3mm α_s - Direct to implant maximum angulation
R = Rotational / Non-Engaging
NR = Non Rotational / Engaging

STANDARD DYNAMIC TIBASE															
	GINGIVAL HEIGHT	α_s	α_c	GINGIVAL HEIGHT	α_s	α_c	GINGIVAL HEIGHT	α_s	α_c	GINGIVAL HEIGHT	α_s	α_c	GINGIVAL HEIGHT	α_s	α_c
	1 mm			mm			mm			mm			mm		
R	31.323.165.01-2	45°	25°	-	-	-	-	-	-	-	-	-	-	-	-
NR	31.313.165.01-2			-	-	-	-	-	-	-	-	-	-	-	-

DYNAMIC 3TIBASE				
GINGIVAL HEIGHT	α_s	α_s	α_s	
	CH-5mm	CH-7mm	CH-9mm	
-	-	-	-	-
-	-	-	-	-

DYNAMIC SCANBODY (LAB/CLIN)				DIGITAL ANALOG
SCANBODY	HEIGHT mm	ADAPTOR	SCREWDRIVER ADAPTOR	DIGITAL ANALOG
52.410.132.01-2	10	50.313.165.01-2	43.621.415.01-2	34.613.165.01-2
52.412.132.01-2	12			

DYNAMIC MILLING TOOL		
DYNAMIC MILLING TOOL	SHANK	α_{di}
33.345.804.01-2*	3	30°
33.445.804.01-2*	4	
33.645.804.01-2*	6	

*Only for R

DYNAMIC SCREWS			
DYNAMIC SCREW	HIGH DYNAMIC SCREW	DYNAMIC SCREWDRIVER	SCREWDRIVER LENGTH (mm)
41.314.076.01-2	-	43.618.201.01-2	18
		43.624.201.01-2	24
		43.632.201.01-2	32

STRAIGHT SCREWS	
STRAIGHT SCREW	SCREWDRIVER Hex. 1,20
40.314.003.03-2	43.601.103.02-2

ANALOG	LAB SCANBODY
-	30.413.002.01-2

LIBRARY OPTIONS
GH = Gingival Height α_s - Standard maximum angulation
CH = Cement Height α_c - Captive maximum angulation
IG = Adaptor 3mm α_s - Direct to implant maximum angulation
R = Rotational / Non-Engaging
NR = Non Rotational / Engaging

STANDARD DYNAMIC TIBASE															
	GINGIVAL HEIGHT	α_s	α_c	GINGIVAL HEIGHT	α_s	α_c	GINGIVAL HEIGHT	α_s	α_c	GINGIVAL HEIGHT	α_s	α_c	GINGIVAL HEIGHT	α_s	α_c
	0.9 mm			mm			mm			mm			mm		
R	31.320.166.01-2	45°	30°	-	-	-	-	-	-	-	-	-	-	-	-
NR	31.310.166.01-2			-	-	-	-	-	-	-	-	-	-	-	-

DYNAMIC 3TIBASE				
	GINGIVAL HEIGHT	α_s	α_s	α_s
		CH-5mm	CH- 7mm	CH- 9mm
-	-	-	-	-
-	-	-	-	-

DYNAMIC SCANBODY (LAB/CLIN)				DIGITAL ANALOG
SCANBODY	HEIGHT mm	ADAPTOR	SCREWDRIVER ADAPTOR	DIGITAL ANALOG
52.410.128.01-2	10	50.310.166.03-2 <small>IG-3mm</small>	43.621.415.01-2	34.610.166.01-2
-	-			
-	-			

DYNAMIC MILLING TOOL		
DYNAMIC MILLING TOOL	SHANK	α_{di}
33.330.734.01-2	3	20°
33.430.734.01-2	4	
33.630.734.01-2	6	

DYNAMIC SCREWS			
DYNAMIC SCREW	HIGH DYNAMIC SCREW	DYNAMIC SCREWDRIVER	SCREWDRIVER LENGTH (mm)
41.314.084.01-2	-	43.618.201.01-2	18
		43.624.201.01-2	24
		43.632.201.01-2	32

STRAIGHT SCREWS	
STRAIGHT SCREW	SCREWDRIVER Hex. 1.25
40.314.004.02-2	43.601.104.01-2

ANALOG	LAB SCANBODY
-	30.410.006.01-2

LIBRARY OPTIONS
GH = Gingival Height α_s - Standard maximum angulation
CH = Cement Height α_c - Captive maximum angulation
IG = Adaptor 3mm α_{di} - Direct to implant maximum angulation
R = Rotational / Non-Engaging
NR = Non Rotational / Engaging

STANDARD DYNAMIC TIBASE															
	GINGIVAL HEIGHT	α_s	α_c	GINGIVAL HEIGHT	α_s	α_c	GINGIVAL HEIGHT	α_s	α_c	GINGIVAL HEIGHT	α_s	α_c	GINGIVAL HEIGHT	α_s	α_c
	0.9 mm			mm			mm			mm			mm		
R	31.322.167.01-2	43°	30°	-	-	-	-	-	-	-	-	-	-	-	-
NR	31.312.167.01-2			-	-	-	-	-	-	-	-	-	-	-	-

DYNAMIC 3TIBASE				
	GINGIVAL HEIGHT	α_s	α_s	α_s
		CH-5mm	CH- 7mm	CH- 9mm
-	-	-	-	-
-	-	-	-	-

DYNAMIC SCANBODY (LAB/CLIN)				DIGITAL ANALOG
SCANBODY	HEIGHT mm	ADAPTOR	SCREWDRIVER ADAPTOR	DIGITAL ANALOG
52.410.117.01-2	10	50.313.167.03-2 <small>IG- 3mm</small>	43.621.410.01-2	34.613.167.01-2
52.410.117.01-2			43.624.410.01-2	
52.412.117.01-2	12			

DYNAMIC MILLING TOOL		
DYNAMIC MILLING TOOL	SHANK	α_{di}
33.330.734.01-2	3	20°
33.430.734.01-2	4	
33.630.734.01-2	6	

DYNAMIC SCREWS			
DYNAMIC SCREW	HIGH DYNAMIC SCREW	DYNAMIC SCREWDRIVER	SCREWDRIVER LENGTH (mm)
41.316.084.02-2	-	43.618.201.01-2	18
		43.624.201.01-2	24
		43.632.201.01-2	32

STRAIGHT SCREWS	
STRAIGHT SCREW	SCREWDRIVER Hex. 1.25
40.316.004.01-2	43.601.104.01-2

ANALOG	LAB SCANBODY
-	30.412.001.01-2

LIBRARY OPTIONS
GH = Gingival Height α_s - Standard maximum angulation
CH = Cement Height α_c - Captive maximum angulation
IG = Adaptor 3mm α_{di} - Direct to implant maximum angulation
R = Rotational / Non-Engaging
NR = Non Rotational / Engaging

STANDARD DYNAMIC TIBASE															
	GINGIVAL HEIGHT	α_s	α_c	GINGIVAL HEIGHT	α_s	α_c	GINGIVAL HEIGHT	α_s	α_c	GINGIVAL HEIGHT	α_s	α_c	GINGIVAL HEIGHT	α_s	α_c
	0,6 mm			1,5 mm			mm			3 mm			mm		
R	31.322.169.01-2	45°	29°	31.322.169.02-2	25	-	-	-	-	31.322.169.04-2	20	-	-	-	-
NR	31.312.169.01-2			31.312.169.02-2			-			31.312.169.04-2			-		

DYNAMIC 3TIBASE								
	GINGIVAL HEIGHT	α_s	α_c	α_s	GINGIVAL HEIGHT	α_s	α_c	α_s
	1,5 mm	CH-5mm	CH- 7mm	CH- 9mm	3 mm	CH-5mm	CH- 7mm	CH- 9mm
R	31.322.169.22-2	30°	25°	15°	31.322.169.24-2	25°	20°	15°
NR	31.312.169.22-2				31.312.169.24-2			

DYNAMIC SCANBODY (LAB/CLIN)				DIGITAL ANALOG
SCANBODY	HEIGHT mm	ADAPTOR	SCREWDRIVER ADAPTOR	DIGITAL ANALOG
52.410.117.01-2	10	50.312.169.01-2	43.621.410.01-2 43.624.410.01-2	34.612.169.01-2
52.412.117.01-2	12			

DYNAMIC MILLING TOOL		
DYNAMIC MILLING TOOL	SHANK	α_{di}
33.330.734.01-2	3	25°
33.430.734.01-2	4	
33.630.734.01-2	6	

DYNAMIC SCREWS			
DYNAMIC SCREW	HIGH DYNAMIC SCREW	DYNAMIC SCREWDRIVER	SCREWDRIVER LENGTH (mm)
41.317.070.01-2	-	43.618.201.01-2	18
		43.624.201.01-2	24
		43.632.201.01-2	32

STRAIGHT SCREWS	
STRAIGHT SCREW	SCREWDRIVER
-	-

ANALOG	LAB SCANBODY
-	30.412.001.01-2

MULTI-UNIT				
	GINGIVAL HEIGHT	GINGIVAL HEIGHT	GINGIVAL HEIGHT	GINGIVAL HEIGHT
	1 mm	2 mm	3 mm	4 mm
R	42.302.169.01-2	42.302.169.02-2	42.302.169.03-2	42.302.169.04-2

LIBRARY OPTIONS
GH = Gingival Height α_s - Standard maximum angulation
CH = Cement Height α_c - Captive maximum angulation
IG = Adaptor 3mm α_{di} - Direct to implant maximum angulation
R = Rotational / Non-Engaging
NR = Non Rotational / Engaging

STANDARD DYNAMIC TIBASE															
	GINGIVAL HEIGHT	α_s	α_c	GINGIVAL HEIGHT	α_s	α_c	GINGIVAL HEIGHT	α_s	α_c	GINGIVAL HEIGHT	α_s	α_c	GINGIVAL HEIGHT	α_s	α_c
	0,3 mm			mm			mm			mm			mm		
R	31.322.170.01-2	38°	-	-	-	-	-	-	-	-	-	-	-	-	-
NR	31.312.170.01-2			-			-			-			-		

DYNAMIC 3TIBASE				
	GINGIVAL HEIGHT	α_s	α_c	α_s
	0,3 mm	CH-5mm	CH- 7mm	CH- 9mm
R	31.322.170.21-2	30°	20°	15°
NR	31.312.170.21-2			

DYNAMIC SCANBODY (LAB/CLIN)				DIGITAL ANALOG
SCANBODY	HEIGHT mm	ADAPTOR	SCREWDRIVER ADAPTOR	DIGITAL ANALOG
-	-	-	-	-
-	-			

DYNAMIC MILLING TOOL		
DYNAMIC MILLING TOOL	SHANK	α_{di}
33.390.754.01-2	3	25°
33.490.754.01-2	4	
33.690.754.01-2	6	

DYNAMIC SCREWS			
DYNAMIC SCREW	HIGH DYNAMIC SCREW	DYNAMIC SCREWDRIVER	SCREWDRIVER LENGTH (mm)
41.316.079.02-2	-	43.618.201.01-2	18
		43.624.201.01-2	24
		43.632.201.01-2	32

STRAIGHT SCREWS	
STRAIGHT SCREW	SCREWDRIVER Hex. 1.20
-	-

ANALOG	LAB SCANBODY
-	30.410.006.01-2

LIBRARY OPTIONS
GH = Gingival Height α_s - Standard maximum angulation
CH = Cement Height α_c - Captive maximum angulation
IG = Adaptor 3mm α_{di} - Direct to implant maximum angulation
R = Rotational / Non-Engaging
NR = Non Rotational / Engaging

STANDARD DYNAMIC TIBASE															
	GINGIVAL HEIGHT	α_s	α_c	GINGIVAL HEIGHT	α_s	α_c	GINGIVAL HEIGHT	α_s	α_c	GINGIVAL HEIGHT	α_s	α_c	GINGIVAL HEIGHT	α_s	α_c
	0.3 mm			mm			mm			mm			mm		
R	31.323.171.01-2	35°	-	-	-	-	-	-	-	-	-	-	-	-	-
NR	31.313.171.01-2		-	-	-	-	-	-	-	-	-	-	-	-	-

DYNAMIC 3TIBASE				
	GINGIVAL HEIGHT	α_s	α_c	α_s
		CH-5mm	CH-7mm	CH-9mm
-	-	-	-	-
-	-	-	-	-

DYNAMIC SCANBODY (LAB/CLIN)				DIGITAL ANALOG
SCANBODY	HEIGHT mm	ADAPTOR	SCREWDRIVER ADAPTOR	DIGITAL ANALOG
-	-	-	-	-
-	-	-	-	-

DYNAMIC MILLING TOOL		
DYNAMIC MILLING TOOL	SHANK	α_{di}
33.390.754.01-2	3	25°
33.490.754.01-2	4	
33.690.754.01-2	6	

DYNAMIC SCREWS			
DYNAMIC SCREW	HIGH DYNAMIC SCREW	DYNAMIC SCREWDRIVER	SCREWDRIVER LENGTH (mm)
41.316.079.02-2	-	43.618.201.01-2	18
		43.624.201.01-2	24
		43.632.201.01-2	32

STRAIGHT SCREWS	
STRAIGHT SCREW	SCREWDRIVER Hex. 1.20
-	-

ANALOG	LAB SCANBODY
-	30.412.001.01-2

LIBRARY OPTIONS
GH = Gingival Height α_s - Standard maximum angulation
CH = Cement Height α_c - Captive maximum angulation
IG = Adaptor 3mm α_s - Direct to implant maximum angulation
R = Rotational / Non-Engaging
NR = Non Rotational / Engaging

STANDARD DYNAMIC TIBASE															
	GINGIVAL HEIGHT	α_s	α_c	GINGIVAL HEIGHT	α_s	α_c	GINGIVAL HEIGHT	α_s	α_c	GINGIVAL HEIGHT	α_s	α_c	GINGIVAL HEIGHT	α_s	α_c
	0.5 mm			mm			mm			mm			mm		
R	-	35°	-	-	-	-	-	-	-	-	-	-	-	-	-
NR	31.310.176.01-2		-	-	-	-	-	-	-	-	-	-	-	-	-

DYNAMIC 3TIBASE				
	GINGIVAL HEIGHT	α_s	α_c	α_s
	mm	CH-5mm	CH-7mm	CH-9mm
R	-	-	-	-
NR	-	-	-	-

DYNAMIC SCANBODY (LAB/CLIN)				DIGITAL ANALOG
SCANBODY	HEIGHT mm	ADAPTOR	SCREWDRIVER ADAPTOR	DIGITAL ANALOG
52.408.138.01-2	8	50.310.176.01-2	43.621.415.01-2	34.610.176.01-2
-	-			
-	-			

DYNAMIC MILLING TOOL		
DYNAMIC MILLING TOOL	SHANK	α_{di}
33.360.756.01-2	3	30°
33.460.756.01-2	4	
33.660.756.01-2	6	

DYNAMIC SCREWS			
DYNAMIC SCREW	HIGH DYNAMIC SCREW	DYNAMIC SCREWDRIVER	SCREWDRIVER LENGTH (mm)
41.314.044.01-2	-	43.618.201.01-2	18
		43.624.201.01-2	24
		43.632.201.01-2	32

STRAIGHT SCREWS	
STRAIGHT SCREW	SCREWDRIVER Hex. 1.20
-	-

ANALOG	LAB SCANBODY
-	30.410.006.01-2

LIBRARY OPTIONS
GH = Gingival Height α_s - Standard maximum angulation
CH = Cement Height α_c - Captive maximum angulation
IG = Adaptor 3mm α_s - Direct to implant maximum angulation
R = Rotational / Non-Engaging
NR = Non Rotational / Engaging

STANDARD DYNAMIC TIBASE															
	GINGIVAL HEIGHT	α_s	α_c	GINGIVAL HEIGHT	α_s	α_c	GINGIVAL HEIGHT	α_s	α_c	GINGIVAL HEIGHT	α_s	α_c	GINGIVAL HEIGHT	α_s	α_c
	1.5 mm			mm			mm			mm			mm		
R	31.320.178.01-2	45°	-	-	-	-	-	-	-	-	-	-	-	-	-
NR	31.310.178.01-2		-	-	-	-	-	-	-	-	-	-	-	-	-

DYNAMIC 3TIBASE				
GINGIVAL HEIGHT	α_s	α_c	α_s	α_s
	CH-5mm	CH-7mm	CH-9mm	
-	-	-	-	-
-	-	-	-	-

DYNAMIC SCANBODY (LAB/CLIN)				DIGITAL ANALOG
SCANBODY	HEIGHT mm	ADAPTOR	SCREWDRIVER ADAPTOR	DIGITAL ANALOG
-	-	-	-	-
-	-	-	-	-

DYNAMIC MILLING TOOL		
DYNAMIC MILLING TOOL	SHANK	α_{di}
-	-	-
-	-	-

DYNAMIC SCREWS			
DYNAMIC SCREW	HIGH DYNAMIC SCREW	DYNAMIC SCREWDRIVER	SCREWDRIVER LENGTH (mm)
41.316.080.01-2	-	43.618.201.01-2	18
		43.624.201.01-2	24
		43.632.201.01-2	32

STRAIGHT SCREWS	
STRAIGHT SCREW	SCREWDRIVER
-	-

ANALOG	LAB SCANBODY
-	30.410.006.01-2

LIBRARY OPTIONS
GH = Gingival Height α_s - Standard maximum angulation
CH = Cement Height α_c - Captive maximum angulation
IG = Adaptor 3mm α_s - Direct to implant maximum angulation
R = Rotational / Non-Engaging
NR = Non Rotational / Engaging

STANDARD DYNAMIC TIBASE															
	GINGIVAL HEIGHT	α_s	α_c	GINGIVAL HEIGHT	α_s	α_c	GINGIVAL HEIGHT	α_s	α_c	GINGIVAL HEIGHT	α_s	α_c	GINGIVAL HEIGHT	α_s	α_c
	0.4 mm			mm			mm			mm			mm		
R	31.322.181.01-2	45°	-	-	-	-	-	-	-	-	-	-	-	-	-
NR	-		-	-	-	-	-	-	-	-	-	-	-	-	-

DYNAMIC 3TIBASE				
GINGIVAL HEIGHT	α_s	α_c	α_s	α_s
	0.4 mm	CH-5mm	CH-7mm	CH-9mm
R	31.322.181.21-2	30°	30°	20°
NR	-		-	-

DYNAMIC SCANBODY (LAB/CLIN)				DIGITAL ANALOG
SCANBODY	HEIGHT mm	ADAPTOR	SCREWDRIVER ADAPTOR	DIGITAL ANALOG
52.408.112.01-2	8	50.312.181.01-2	43.620.411.01-2	-
-	-			
-	-			

DYNAMIC MILLING TOOL		
DYNAMIC MILLING TOOL	SHANK	α_{di}
33.360.756.01-2	3	30°
33.460.756.01-2	4	
33.660.756.01-2	6	

SCANALOG
23.412.181.01-2

DYNAMIC SCREWS				
DYNAMIC SCREW	HIGH DYNAMIC SCREW	DYNAMIC SCREWDRIVER	SCREWDRIVER LENGTH (mm)	SCREWDRIVER LENGTH (mm)
41.318.043.01-2	-	43.618.201.01-2	18	
		43.624.201.01-2	24	
		43.632.201.01-2	32	

STRAIGHT SCREWS	
STRAIGHT SCREW	SCREWDRIVER
-	-

ANALOG	LAB SCANBODY
-	30.413.005.01-2

LIBRARY OPTIONS
GH = Gingival Height α_s - Standard maximum angulation
CH = Cement Height α_c - Captive maximum angulation
IG = Adaptor 3mm α_s - Direct to implant maximum angulation
R = Rotational / Non-Engaging
NR = Non Rotational / Engaging

STANDARD DYNAMIC TIBASE															
	GINGIVAL HEIGHT	α_s	α_c	GINGIVAL HEIGHT	α_s	α_c	GINGIVAL HEIGHT	α_s	α_c	GINGIVAL HEIGHT	α_s	α_c	GINGIVAL HEIGHT	α_s	α_c
	0.5 mm			mm			mm			mm			mm		
R	31.322.183.01-2	45°	-	-	-	-	-	-	-	-	-	-	-	-	-
NR	-			-	-	-	-	-	-	-	-	-	-	-	-

DYNAMIC 3TIBASE

GINGIVAL HEIGHT	α_s	α_c	α_s
CH-5mm	CH-7mm	CH-9mm	
-	-	-	-
-	-	-	-

REFERENCE SCANBODY

SCANBODY	PEEK PINS	mm
54.322.183.31-2	49.414.000.01-2	6
	49.415.000.01-2	9
	49.416.000.01-2	13
	CAPS	mm
	49.418.000.01-2	3.8
	49.419.000.01-2	6
	49.420.000.01-2	8

DYNAMIC SCANBODY (LAB/CLIN) DIGITAL ANALOG

SCANBODY	HEIGHT mm	ADAPTOR	SCREWDRIVER ADAPTOR	DIGITAL ANALOG
52.408.136.01-2	8	50.312.183.01-2	43.620.411.01-2	34.612.183.01-2
-	-			
-	-			

DYNAMIC MILLING TOOL

DYNAMIC MILLING TOOL	SHANK	α_{di}
33.330.734.01-2	3	30°
33.430.734.01-2	4	
33.630.734.01-2	6	

DYNAMIC SCREWS

DYNAMIC SCREW	HIGH DYNAMIC SCREW	DYNAMIC SCREWDRIVER	SCREWDRIVER LENGTH (mm)
41.316.048.02-2	-	43.618.201.01-2	18
		43.624.201.01-2	24
		43.632.201.01-2	32

STRAIGHT SCREWS

STRAIGHT SCREW	SCREWDRIVER
-	-

ANALOG LAB SCANBODY

-	-
---	---

LIBRARY OPTIONS
GH = Gingival Height α_s - Standard maximum angulation
CH = Cement Height α_c - Captive maximum angulation
IG = Adaptor 3mm α_{di} - Direct to implant maximum angulation
R = Rotational / Non-Engaging
NR = Non Rotational / Engaging

STANDARD DYNAMIC TIBASE															
	GINGIVAL HEIGHT	α_s	α_c	GINGIVAL HEIGHT	α_s	α_c	GINGIVAL HEIGHT	α_s	α_c	GINGIVAL HEIGHT	α_s	α_c	GINGIVAL HEIGHT	α_s	α_c
	1.2 mm			2.5 mm			3.5 mm			mm			mm		
R	31.323.186.01-2	40°	30°	31.323.186.02-2	20°	18°	31.323.186.03-2	15°	-	-	°	°	-	°	°
NR	31.313.186.01-2			31.313.186.02-2			31.313.186.03-2			-	°	°	-	°	°

DYNAMIC 3TIBASE

GINGIVAL HEIGHT	α_s	α_c	α_s	GINGIVAL HEIGHT	α_s	α_c	α_s	
1.2 mm	CH-5mm	CH-7mm	CH-9mm	2.5 mm	CH-5mm	CH-7mm	CH-9mm	
R	31.323.186.21-2	30°	25°	15°	31.323.186.22-2	30°	25°	15°
NR	31.313.186.21-2				31.313.186.22-2			

DYNAMIC SCANBODY (LAB/CLIN) DIGITAL ANALOG

SCANBODY	HEIGHT mm	ADAPTOR	SCREWDRIVER ADAPTOR	DIGITAL ANALOG
52.408.101.01-2	8	50.313.186.04-2 (IG-3mm)	43.621.410.01-2	34.613.186.01-2
52.410.101.01-2	10		43.624.410.01-2	
52.412.101.01-2	12			

DYNAMIC MILLING TOOL

DYNAMIC MILLING TOOL	SHANK	α_{di}
33.330.734.01-2	3	25
33.430.734.01-2	4	
33.630.734.01-2	6	

SCANBODY OP

SCANBODY	PEEK PINS	mm
54.315.186.21-2	49.414.000.01-2	6
	49.415.000.01-2	9
	49.416.000.01-2	13

DYNAMIC SCREWS

DYNAMIC SCREW	HIGH DYNAMIC SCREW	DYNAMIC SCREWDRIVER	SCREWDRIVER LENGTH (mm)
41.316.084.02-2	-	43.618.201.01-2	18
		43.624.201.01-2	24
		43.632.201.01-2	32

STRAIGHT SCREWS

STRAIGHT SCREW	SCREWDRIVER
-	-

ANALOG LAB SCANBODY

-	30.413.002.01-2
---	-----------------

MULTI-UNIT

	GINGIVAL HEIGHT	GINGIVAL HEIGHT	GINGIVAL HEIGHT	GINGIVAL HEIGHT	GINGIVAL HEIGHT
	1 mm	2 mm	3 mm	4 mm	5 mm
R	42.303.186.01-2	42.303.186.02-2	42.303.186.03-2	42.303.186.04-2	42.303.186.05-2

LIBRARY OPTIONS
GH = Gingival Height α_s - Standard maximum angulation
CH = Cement Height α_c - Captive maximum angulation
IG = Adaptor 3mm α_{di} - Direct to implant maximum angulation
R = Rotational / Non-Engaging
NR = Non Rotational / Engaging

STANDARD DYNAMIC TIBASE															
	GINGIVAL HEIGHT	α_s	α_c	GINGIVAL HEIGHT	α_s	α_c	GINGIVAL HEIGHT	α_s	α_c	GINGIVAL HEIGHT	α_s	α_c	GINGIVAL HEIGHT	α_s	α_c
	0.3 mm			0.5 mm			1 mm			mm			mm		
R	31.322.009.01-2	45°	25°	31.322.009.02-2	25°	25°	31.322.009.03-2	25°	-	-	-	-	-	-	-
NR	31.312.009.01-2			31.312.009.02-2			31.312.009.03-2								

DYNAMIC 3TIBASE				
	GINGIVAL HEIGHT	α_s	α_c	α_s
		CH-5mm	CH-7mm	CH-9mm
-	-	-	-	-
-	-	-	-	-

DYNAMIC SCANBODY (LAB/CLIN)				DIGITAL ANALOG
SCANBODY	HEIGHT mm	ADAPTOR	SCREWDRIVER ADAPTOR	DIGITAL ANALOG
52.410.114.01-2	10	50.312.187.01-2	43.621.410.01-2 43.624.410.01-2	34.612.187.01-2
52.412.114.01-2	12			

DYNAMIC MILLING TOOL		
DYNAMIC MILLING TOOL	SHANK	α_{di}
33.390.716.01-2	3	25°
33.490.716.01-2	4	
33.690.716.01-2	6	

DYNAMIC SCREWS			
DYNAMIC SCREW	HIGH DYNAMIC SCREW	DYNAMIC SCREWDRIVER	SCREWDRIVER LENGTH (mm)
41.316.059.01-2	-	43.618.201.01-2 43.624.201.01-2 43.632.201.01-2	18 24 32

STRAIGHT SCREWS	
STRAIGHT SCREW	SCREWDRIVER
-	-

ANALOG	LAB SCANBODY
-	30.412.001.01-2

LIBRARY OPTIONS
GH = Gingival Height α_s - Standard maximum angulation
CH = Cement Height α_c - Captive maximum angulation
IG = Adaptor 3mm α_s - Direct to implant maximum angulation
R = Rotational / Non-Engaging
NR = Non Rotational / Engaging

STANDARD DYNAMIC TIBASE															
	GINGIVAL HEIGHT	α_s	α_c	GINGIVAL HEIGHT	α_s	α_c	GINGIVAL HEIGHT	α_s	α_c	GINGIVAL HEIGHT	α_s	α_c	GINGIVAL HEIGHT	α_s	α_c
	1.5 mm			mm			3.5 mm			mm			mm		
R	31.320.188.01-2	45°	-	-	-	-	-	-	-	-	-	-	-	-	-
NR	31.310.188.01-2			-			-			-			-		

DYNAMIC 3TIBASE				
	GINGIVAL HEIGHT	α_s	α_c	α_s
		CH-5mm	CH-7mm	CH-9mm
-	-	-	-	-
-	-	-	-	-

DYNAMIC SCANBODY (LAB/CLIN)				DIGITAL ANALOG
SCANBODY	HEIGHT mm	ADAPTOR	SCREWDRIVER ADAPTOR	DIGITAL ANALOG
-	-	-	-	-
-	-			
-	-			

DYNAMIC MILLING TOOL		
DYNAMIC MILLING TOOL	SHANK	α_{di}
-	-	-
-	-	
-	-	

DYNAMIC SCREWS			
DYNAMIC SCREW	HIGH DYNAMIC SCREW	DYNAMIC SCREWDRIVER	SCREWDRIVER LENGTH (mm)
41.315.078.01-2	-	43.618.201.01-2 43.624.201.01-2 43.632.201.01-2	18 24 32

STRAIGHT SCREWS	
STRAIGHT SCREW	SCREWDRIVER
-	-

ANALOG	LAB SCANBODY
-	30.410.006.01-2

LIBRARY OPTIONS
GH = Gingival Height α_s - Standard maximum angulation
CH = Cement Height α_c - Captive maximum angulation
IG = Adaptor 3mm α_s - Direct to implant maximum angulation
R = Rotational / Non-Engaging
NR = Non Rotational / Engaging

STANDARD DYNAMIC TIBASE															
	GINGIVAL HEIGHT	α_s	α_c	GINGIVAL HEIGHT	α_s	α_c	GINGIVAL HEIGHT	α_s	α_c	GINGIVAL HEIGHT	α_s	α_c	GINGIVAL HEIGHT	α_s	α_c
	1.8 mm			mm			mm			mm			mm		
R	31.320.190.01-2	45°	-	-	-	-	-	-	-	-	-	-	-	-	-
NR	31.310.190.01-2			-	-	-	-	-	-	-	-	-	-	-	-

DYNAMIC 3TIBASE				
GINGIVAL HEIGHT	α_s	α_s	α_s	
	CH-5mm	CH- 7mm	CH- 9mm	
-	-	-	-	-
-	-	-	-	-

DYNAMIC SCANBODY (LAB/CLIN)				DIGITAL ANALOG
SCANBODY	HEIGHT mm	ADAPTOR	SCREWDRIVER ADAPTOR	DIGITAL ANALOG
-	-	-	-	-
-	-	-	-	-
-	-	-	-	-

DYNAMIC MILLING TOOL		
DYNAMIC MILLING TOOL	SHANK	α_{di}
-	-	-
-	-	-
-	-	-

DYNAMIC SCREWS			
DYNAMIC SCREW	HIGH DYNAMIC SCREW	DYNAMIC SCREWDRIVER	SCREWDRIVER LENGTH (mm)
41.316.084.02-2	-	43.618.201.01-2	18
		43.624.201.01-2	24
		43.632.201.01-2	32

STRAIGHT SCREWS	
STRAIGHT SCREW	SCREWDRIVER
-	-

ANALOG	LAB SCANBODY
-	30.410.006.01-2

LIBRARY OPTIONS

- GH = Gingival Height α_s - Standard maximum angulation
- CH = Cement Height α_c - Captive maximum angulation
- IG = Adaptor 3mm α_s - Direct to implant maximum angulation
- R** = Rotational / Non-Engaging
- NR** = Non Rotational / Engaging

STANDARD DYNAMIC TIBASE															
	GINGIVAL HEIGHT	α_s	α_c	GINGIVAL HEIGHT	α_s	α_c	GINGIVAL HEIGHT	α_s	α_c	GINGIVAL HEIGHT	α_s	α_c	GINGIVAL HEIGHT	α_s	α_c
	0.8 mm			mm			mm			mm			mm		
R	31.322.191.01-2	45°	-	-	-	-	-	-	-	-	-	-	-	-	-
NR	31.312.191.01-2			-	-	-	-	-	-	-	-	-	-	-	-

DYNAMIC 3TIBASE				
GINGIVAL HEIGHT	α_s	α_s	α_s	
	CH-5mm	CH- 7mm	CH- 9mm	
-	-	-	-	-
-	-	-	-	-

DYNAMIC SCANBODY (LAB/CLIN)				DIGITAL ANALOG
SCANBODY	HEIGHT mm	ADAPTOR	SCREWDRIVER ADAPTOR	DIGITAL ANALOG
-	-	-	-	-
-	-	-	-	-
-	-	-	-	-

DYNAMIC MILLING TOOL		
DYNAMIC MILLING TOOL	SHANK	α_{di}
-	-	-
-	-	-
-	-	-

DYNAMIC SCREWS			
DYNAMIC SCREW	HIGH DYNAMIC SCREW	DYNAMIC SCREWDRIVER	SCREWDRIVER LENGTH (mm)
41.316.084.02-2	-	43.618.201.01-2	18
		43.624.201.01-2	24
		43.632.201.01-2	32

STRAIGHT SCREWS	
STRAIGHT SCREW	SCREWDRIVER
-	-

ANALOG	LAB SCANBODY
-	30.412.001.01-2

LIBRARY OPTIONS

- GH = Gingival Height α_s - Standard maximum angulation
- CH = Cement Height α_c - Captive maximum angulation
- IG = Adaptor 3mm α_s - Direct to implant maximum angulation
- R** = Rotational / Non-Engaging
- NR** = Non Rotational / Engaging

STANDARD DYNAMIC TIBASE															
	GINGIVAL HEIGHT	α_s	α_c	GINGIVAL HEIGHT	α_s	α_c	GINGIVAL HEIGHT	α_s	α_c	GINGIVAL HEIGHT	α_s	α_c	GINGIVAL HEIGHT	α_s	α_c
	0.3 mm			mm			mm			mm			mm		
R	31.323.192.01-2	45°	-	-	-	-	-	-	-	-	-	-	-	-	-
-	-	-	-	-	-	-	-	-	-	-	-	-	-	-	-

DYNAMIC 3TIBASE				
GINGIVAL HEIGHT	α_s	α_s	α_s	
	CH-5mm	CH-7mm	CH-9mm	
-	-	-	-	-
-	-	-	-	-

DYNAMIC SCANBODY (LAB/CLIN)				DIGITAL ANALOG
SCANBODY	HEIGHT mm	ADAPTOR	SCREWDRIVER ADAPTOR	DIGITAL ANALOG
-	-	-	-	-
-	-	-	-	-
-	-	-	-	-

DYNAMIC MILLING TOOL		
DYNAMIC MILLING TOOL	SHANK	α_{di}
-	-	-
-	-	-
-	-	-

DYNAMIC SCREWS			
DYNAMIC SCREW	HIGH DYNAMIC SCREW	DYNAMIC SCREWDRIVER	SCREWDRIVER LENGTH (mm)
41.316.048.01-2	-	43.618.201.01-2	18
		43.624.201.01-2	24
		43.632.201.01-2	32

STRAIGHT SCREWS	
STRAIGHT SCREW	SCREWDRIVER
-	-

ANALOG	LAB SCANBODY
-	30.413.005.01-2

LIBRARY OPTIONS

GH = Gingival Height α_s - Standard maximum angulation
CH = Cement Height α_c - Captive maximum angulation
IG = Adaptor 3mm α_s - Direct to implant maximum angulation
R = Rotational / Non-Engaging
NR = Non Rotational / Engaging

STANDARD DYNAMIC TIBASE															
	GINGIVAL HEIGHT	α_s	α_c	GINGIVAL HEIGHT	α_s	α_c	GINGIVAL HEIGHT	α_s	α_c	GINGIVAL HEIGHT	α_s	α_c	GINGIVAL HEIGHT	α_s	α_c
	0.3 mm			mm			mm			mm			mm		
R	31.323.193.01-2	45°	-	-	-	-	-	-	-	-	-	-	-	-	-
-	-	-	-	-	-	-	-	-	-	-	-	-	-	-	-

DYNAMIC 3TIBASE				
GINGIVAL HEIGHT	α_s	α_s	α_s	
	CH-5mm	CH-7mm	CH-9mm	
-	-	-	-	-
-	-	-	-	-

DYNAMIC SCANBODY (LAB/CLIN)				DIGITAL ANALOG
SCANBODY	HEIGHT mm	ADAPTOR	SCREWDRIVER ADAPTOR	DIGITAL ANALOG
-	-	-	-	-
-	-	-	-	-
-	-	-	-	-

DYNAMIC MILLING TOOL		
DYNAMIC MILLING TOOL	SHANK	α_{di}
-	-	-
-	-	-
-	-	-

DYNAMIC SCREWS			
DYNAMIC SCREW	HIGH DYNAMIC SCREW	DYNAMIC SCREWDRIVER	SCREWDRIVER LENGTH (mm)
41.318.051.02-2	-	43.618.201.01-2	18
		43.624.201.01-2	24
		43.632.201.01-2	32

STRAIGHT SCREWS	
STRAIGHT SCREW	SCREWDRIVER
-	-

REFERENCE SCANBODY		
SCANBODY	PEEK PINS	mm
54.322.193.31-2	49.414.000.01-2	6
	49.415.000.01-2	9
	49.416.000.01-2	13
	CAPS	mm
	49.418.000.01-2	3.8
	49.419.000.01-2	6
49.420.000.01-2	8	

SCREWDRIVER 43.625.105.01-2

ANALOG	LAB SCANBODY
-	30.413.005.01-2

LIBRARY OPTIONS

GH = Gingival Height α_s - Standard maximum angulation
CH = Cement Height α_c - Captive maximum angulation
IG = Adaptor 3mm α_s - Direct to implant maximum angulation
R = Rotational / Non-Engaging
NR = Non Rotational / Engaging

STANDARD DYNAMIC TIBASE															
	GINGIVAL HEIGHT	α_s	α_c	GINGIVAL HEIGHT	α_s	α_c	GINGIVAL HEIGHT	α_s	α_c	GINGIVAL HEIGHT	α_s	α_c	GINGIVAL HEIGHT	α_s	α_c
	0.5 mm			mm			mm			mm			mm		
R	31.323.195.01-2	45°	-	-	-	-	-	-	-	-	-	-	-	-	-
-	-			-	-	-	-	-	-	-	-	-	-	-	-

DYNAMIC 3TIBASE				
	GINGIVAL HEIGHT	α_s	α_s	α_s
		CH-5mm	CH-7mm	CH-9mm
R	31.323.195.21-2	30°	25°	20°
NR	-			

DYNAMIC SCANBODY (LAB/CLIN)				DIGITAL ANALOG
SCANBODY	HEIGHT mm	ADAPTOR	SCREWDRIVER ADAPTOR	DIGITAL ANALOG
-	-	-	-	-
-	-			
-	-			

DYNAMIC MILLING TOOL		
DYNAMIC MILLING TOOL	SHANK	α_{di}
-	-	-
-	-	
-	-	

DYNAMIC SCREWS			
DYNAMIC SCREW	HIGH DYNAMIC SCREW	DYNAMIC SCREWDRIVER	SCREWDRIVER LENGTH (mm)
41.317.041.01-2	-	43.618.201.01-2	18
		43.624.201.01-2	24
		43.632.201.01-2	32

STRAIGHT SCREWS	
STRAIGHT SCREW	SCREWDRIVER
-	-

ANALOG	LAB SCANBODY
-	30.413.005.01-2

LIBRARY OPTIONS
GH = Gingival Height α_s - Standard maximum angulation
CH = Cement Height α_c - Captive maximum angulation
IG = Adaptor 3mm α_s - Direct to implant maximum angulation
R = Rotational / Non-Engaging
NR = Non Rotational / Engaging

STANDARD DYNAMIC TIBASE															
	GINGIVAL HEIGHT	α_s	α_c	GINGIVAL HEIGHT	α_s	α_c	GINGIVAL HEIGHT	α_s	α_c	GINGIVAL HEIGHT	α_s	α_c	GINGIVAL HEIGHT	α_s	α_c
	1.2 mm			2 mm			3 mm			mm			mm		
R	31.320.196.01-2	40°	-	31.320.196.02-2	25°	-	31.320.196.03-2	25°	-	-	°	°	-	°	°
NR	31.310.196.01-2			31.310.196.02-2			31.310.196.03-2			-	°	°	-	°	°

DYNAMIC 3TIBASE				
	GINGIVAL HEIGHT	α_s	α_s	α_s
		CH-5mm	CH-7mm	CH-9mm
-	-	-	-	-
-	-			

DYNAMIC SCANBODY (LAB/CLIN)				DIGITAL ANALOG
SCANBODY	HEIGHT mm	ADAPTOR	SCREWDRIVER ADAPTOR	DIGITAL ANALOG
-	-	-	-	-
-	-			
-	-			

DYNAMIC MILLING TOOL		
DYNAMIC MILLING TOOL	SHANK	α_{di}
-	-	-
-	-	
-	-	

DYNAMIC SCREWS			
DYNAMIC SCREW	HIGH DYNAMIC SCREW	DYNAMIC SCREWDRIVER	SCREWDRIVER LENGTH (mm)
41.316.086.01-2	-	43.618.201.01-2	18
		43.624.201.01-2	24
		43.632.201.01-2	32

STRAIGHT SCREWS	
STRAIGHT SCREW	SCREWDRIVER
-	-

ANALOG	LAB SCANBODY
-	30.410.006.01-2

LIBRARY OPTIONS
GH = Gingival Height α_s - Standard maximum angulation
CH = Cement Height α_c - Captive maximum angulation
IG = Adaptor 3mm α_s - Direct to implant maximum angulation
R = Rotational / Non-Engaging
NR = Non Rotational / Engaging

STANDARD DYNAMIC TIBASE															
	GINGIVAL HEIGHT	α_s	α_c	GINGIVAL HEIGHT	α_s	α_c	GINGIVAL HEIGHT	α_s	α_c	GINGIVAL HEIGHT	α_s	α_c	GINGIVAL HEIGHT	α_s	α_c
	1.2 mm			2 mm			3 mm			mm			mm		
R	31.322.197.01-2	35°	-	31.322.197.02-2	20°	-	31.322.197.03-2	20°	-	-	°	°	-	°	°
NR	31.312.197.01-2			31.312.197.02-2			31.312.197.03-2			-	°	°	-	°	°

DYNAMIC 3TIBASE				
GINGIVAL HEIGHT	α_s	α_c	α_s	α_s
	CH-5mm	CH-7mm	CH-9mm	
-	-	-	-	-
-	-	-	-	-

DYNAMIC SCANBODY (LAB/CLIN)				DIGITAL ANALOG
SCANBODY	HEIGHT mm	ADAPTOR	SCREWDRIVER ADAPTOR	DIGITAL ANALOG
-	-	-	-	-
-	-	-	-	-
-	-	-	-	-

DYNAMIC MILLING TOOL		
DYNAMIC MILLING TOOL	SHANK	α_{di}
-	-	-
-	-	-
-	-	-

DYNAMIC SCREWS			
DYNAMIC SCREW	HIGH DYNAMIC SCREW	DYNAMIC SCREWDRIVER	SCREWDRIVER LENGTH (mm)
41.316.086.01-2	-	43.618.201.01-2	18
		43.624.201.01-2	24
		43.632.201.01-2	32

STRAIGHT SCREWS	
STRAIGHT SCREW	SCREWDRIVER
-	-

ANALOG	LAB SCANBODY
-	30.412.001.01-2

LIBRARY OPTIONS
GH = Gingival Height α_s - Standard maximum angulation
CH = Cement Height α_c - Captive maximum angulation
IG = Adaptor 3mm α_s - Direct to implant maximum angulation
R = Rotational / Non-Engaging
NR = Non Rotational / Engaging

STANDARD DYNAMIC TIBASE															
	GINGIVAL HEIGHT	α_s	α_c	GINGIVAL HEIGHT	α_s	α_c	GINGIVAL HEIGHT	α_s	α_c	GINGIVAL HEIGHT	α_s	α_c	GINGIVAL HEIGHT	α_s	α_c
	1.2 mm			mm			mm			mm			mm		
R	31.324.198.01-2	40°	-	-	-	-	-	-	-	-	°	°	-	°	°
NR	31.314.198.01-2			-	-	-	-	-	-	-	-	°	°	-	°

DYNAMIC 3TIBASE				
GINGIVAL HEIGHT	α_s	α_c	α_s	α_s
	CH-5mm	CH-7mm	CH-9mm	
-	-	-	-	-
-	-	-	-	-

DYNAMIC SCANBODY (LAB/CLIN)				DIGITAL ANALOG
SCANBODY	HEIGHT mm	ADAPTOR	SCREWDRIVER ADAPTOR	DIGITAL ANALOG
-	-	-	-	-
-	-	-	-	-
-	-	-	-	-

DYNAMIC MILLING TOOL		
DYNAMIC MILLING TOOL	SHANK	α_{di}
-	-	-
-	-	-
-	-	-

DYNAMIC SCREWS			
DYNAMIC SCREW	HIGH DYNAMIC SCREW	DYNAMIC SCREWDRIVER	SCREWDRIVER LENGTH (mm)
41.316.086.01-2	-	43.618.201.01-2	18
		43.624.201.01-2	24
		43.632.201.01-2	32

STRAIGHT SCREWS	
STRAIGHT SCREW	SCREWDRIVER
-	-

ANALOG	LAB SCANBODY
-	30.414.003.01-2

LIBRARY OPTIONS
GH = Gingival Height α_s - Standard maximum angulation
CH = Cement Height α_c - Captive maximum angulation
IG = Adaptor 3mm α_s - Direct to implant maximum angulation
R = Rotational / Non-Engaging
NR = Non Rotational / Engaging

STANDARD DYNAMIC TIBASE															
	GINGIVAL HEIGHT	α_s	α_c	GINGIVAL HEIGHT	α_s	α_c	GINGIVAL HEIGHT	α_s	α_c	GINGIVAL HEIGHT	α_s	α_c	GINGIVAL HEIGHT	α_s	α_c
	0.3 mm			mm			mm			mm			mm		
R	31.322.205.01-2	45°	-	-	0	0	-	0	0	-	0	0	-	0	0
NR	-			-	0	0	-	0	0	-	0	0	-	0	0

DYNAMIC 3TIBASE				
GINGIVAL HEIGHT	α_s	α_s	α_s	
	CH+5mm	CH+7mm	CH+9mm	
-	-	-	-	-
-	-	-	-	-

DYNAMIC SCANBODY (LAB/CLIN)				DIGITAL ANALOG
SCANBODY	HEIGHT mm	ADAPTOR	SCREWDRIVER ADAPTOR	DIGITAL ANALOG
52.408.112.01-2	8	50.312.205.01-2	43.620.411.01-2	34.612.205.01-2
-	-			
-	-			

DYNAMIC MILLING TOOL		
DYNAMIC MILLING TOOL	SHANK	α_{di}
33.390.716.01-2	3	30°
33.490.716.01-2	4	
33.690.716.01-2	6	

DYNAMIC SCREWS			
DYNAMIC SCREW	HIGH DYNAMIC SCREW	DYNAMIC SCREWDRIVER	SCREWDRIVER LENGTH (mm)
41.317.040.01-2	-	43.618.201.01-2	18
		43.624.201.01-2	24
		43.632.201.01-2	32

STRAIGHT SCREWS	
STRAIGHT SCREW	SCREWDRIVER
-	-

ANALOG	LAB SCANBODY
-	30.412.001.01-2

LIBRARY OPTIONS
GH = Gingival Height α_s - Standard maximum angulation
CH = Cement Height α_c - Captive maximum angulation
IG = Adaptor 3mm α_{di} - Direct to implant maximum angulation
R = Rotational / Non-Engaging
NR = Non Rotational / Engaging

STANDARD DYNAMIC TIBASE															
	GINGIVAL HEIGHT	α_s	α_c	GINGIVAL HEIGHT	α_s	α_c	GINGIVAL HEIGHT	α_s	α_c	GINGIVAL HEIGHT	α_s	α_c	GINGIVAL HEIGHT	α_s	α_c
	1.5 mm			mm			3 mm			4 mm			mm		
R	31.320.207.01-2	35°	-	-	-	-	31.320.207.03-2	20°	-	31.320.207.04-2	15°	-	-	-	-
NR	31.310.207.01-2			-	-	-	31.310.207.03-2			31.310.207.04-2			-	-	-

DYNAMIC 3TIBASE								
GINGIVAL HEIGHT	α_s	α_s	α_s	α_s	α_s	α_s	α_s	
	1.5 mm	CH+5mm	CH+7mm	CH+9mm	3 mm	CH+5mm	CH+7mm	CH+9mm
R	31.320.207.21-2	25°	20°	15°	31.320.207.23-2	20°	15°	10°
NR	31.310.207.21-2				31.310.207.23-2			

DYNAMIC SCANBODY (LAB/CLIN)				DIGITAL ANALOG
SCANBODY	HEIGHT mm	ADAPTOR	SCREWDRIVER ADAPTOR	DIGITAL ANALOG
52.410.103.01-2	10	50.310.207.03-2 <small>IG=3mm</small>	43.621.410.01-2 43.624.410.01-2	34.610.207.01-2
-	-			
52.412.103.01-2	12			

DYNAMIC MILLING TOOL		
DYNAMIC MILLING TOOL	SHANK	α_{di}
33.345.856.01-2*	3	30°
33.445.856.01-2*	4	
33.645.856.01-2*	6	

SCANBODY OP		
SCANBODY	PEEK PINS	mm
54.315.207.21-2	49.414.000.01-2	6
	49.415.000.01-2	9
	49.416.000.01-2	13

*Only for R

SCREWDRIVER 43.601.107.01-2

DYNAMIC SCREWS			
DYNAMIC SCREW	HIGH DYNAMIC SCREW	DYNAMIC SCREWDRIVER	SCREWDRIVER LENGTH (mm)
41.316.066.01-2	-	43.618.201.01-2	18
		43.624.201.01-2	24
		43.632.201.01-2	32

STRAIGHT SCREWS	
STRAIGHT SCREW	SCREWDRIVER
-	-

ANALOG	LAB SCANBODY
-	30.410.006.01-2

MULTI-UNIT				
	GINGIVAL HEIGHT	GINGIVAL HEIGHT	GINGIVAL HEIGHT	GINGIVAL HEIGHT
	1 mm	2 mm	3 mm	4 mm
R	42.302.207.01-2	42.302.207.02-2	42.302.207.03-2	42.302.207.04-2

LIBRARY OPTIONS
GH = Gingival Height α_s - Standard maximum angulation
CH = Cement Height α_c - Captive maximum angulation
IG = Adaptor 3mm α_{di} - Direct to implant maximum angulation
R = Rotational / Non-Engaging
NR = Non Rotational / Engaging

STANDARD DYNAMIC TIBASE															
	GINGIVAL HEIGHT	α_s	α_c	GINGIVAL HEIGHT	α_s	α_c	GINGIVAL HEIGHT	α_s	α_c	GINGIVAL HEIGHT	α_s	α_c	GINGIVAL HEIGHT	α_s	α_c
	1.5 mm			mm			mm			mm			mm		
R	31.324.208.01-2	45°	-	-	-	-	-	-	-	-	-	-	-	-	-
NR	31.314.208.01-2		-	-	-	-	-	-	-	-	-	-	-	-	-

DYNAMIC 3TIBASE				
GINGIVAL HEIGHT	α_s	α_c	α_s	α_s
	CH-5mm	CH-7mm	CH-9mm	
-	-	-	-	-
-	-	-	-	-

DYNAMIC SCANBODY (LAB/CLIN)				DIGITAL ANALOG
SCANBODY	HEIGHT mm	ADAPTOR	SCREWDRIVER ADAPTOR	DIGITAL ANALOG
52.410.103.01-2	10	50.310.207.03-2 IG-3mm	43.621.410.01-2 43.624.410.01-2	34.614.208.01-2
52.412.103.01-2	12			

DYNAMIC MILLING TOOL		
DYNAMIC MILLING TOOL	SHANK	α_{di}
33.345.856.01-2*	3	30°
33.445.856.01-2*	4	
33.645.856.01-2*	6	

SCANBODY OP		
SCANBODY	PEEK PINS	mm
54.315.207.21-2	49.414.000.01-2	6
	49.415.000.01-2	9
	49.416.000.01-2	13

*Only for R

SCREWDRIVER 43.601.107.01-2

DYNAMIC SCREWS			
DYNAMIC SCREW	HIGH DYNAMIC SCREW	DYNAMIC SCREWDRIVER	SCREWDRIVER LENGTH (mm)
41.316.066.01-2	-	43.618.201.01-2	18
		43.624.201.01-2	24
		43.632.201.01-2	32

STRAIGHT SCREWS	
STRAIGHT SCREW	SCREWDRIVER
-	-

ANALOG	LAB SCANBODY
-	30.414.003.01-2

MULTI-UNIT				
	GINGIVAL HEIGHT	GINGIVAL HEIGHT	GINGIVAL HEIGHT	GINGIVAL HEIGHT
	1 mm	2 mm	3 mm	4 mm
R	42.302.207.01-2	42.302.207.02-2	42.302.207.03-2	42.302.207.04-2

LIBRARY OPTIONS
GH = Gingival Height α_s - Standard maximum angulation
CH = Cement Height α_c - Captive maximum angulation
IG = Adaptor 3mm α_s - Direct to implant maximum angulation
R = Rotational / Non-Engaging
NR = Non Rotational / Engaging

STANDARD DYNAMIC TIBASE															
	GINGIVAL HEIGHT	α_s	α_c	GINGIVAL HEIGHT	α_s	α_c	GINGIVAL HEIGHT	α_s	α_c	GINGIVAL HEIGHT	α_s	α_c	GINGIVAL HEIGHT	α_s	α_c
	0.5 mm			mm			mm			mm			mm		
R	31.320.229.01-2	40°	-	-	-	-	-	-	-	-	-	-	-	-	-
NR	31.310.229.01-2		-	-	-	-	-	-	-	-	-	-	-	-	-

DYNAMIC 3TIBASE				
GINGIVAL HEIGHT	α_s	α_c	α_s	α_s
	CH-5mm	CH-7mm	CH-9mm	
-	-	-	-	-
-	-	-	-	-

DYNAMIC SCANBODY (LAB/CLIN)				DIGITAL ANALOG
SCANBODY	HEIGHT mm	ADAPTOR	SCREWDRIVER ADAPTOR	DIGITAL ANALOG
-	-	-	-	-
-	-	-	-	-
-	-	-	-	-

DYNAMIC MILLING TOOL		
DYNAMIC MILLING TOOL	SHANK	α_{di}
-	-	-
-	-	-
-	-	-

DYNAMIC SCREWS			
DYNAMIC SCREW	HIGH DYNAMIC SCREW	DYNAMIC SCREWDRIVER	SCREWDRIVER LENGTH (mm)
41.316.064.01-2	-	43.618.201.01-2	18
		43.624.201.01-2	24
		43.632.201.01-2	32

STRAIGHT SCREWS	
STRAIGHT SCREW	SCREWDRIVER
-	-

ANALOG	LAB SCANBODY
-	30.410.006.01-2

LIBRARY OPTIONS
GH = Gingival Height α_s - Standard maximum angulation
CH = Cement Height α_c - Captive maximum angulation
IG = Adaptor 3mm α_s - Direct to implant maximum angulation
R = Rotational / Non-Engaging
NR = Non Rotational / Engaging

STANDARD DYNAMIC TIBASE															
	GINGIVAL HEIGHT	α_s	α_c	GINGIVAL HEIGHT	α_s	α_c	GINGIVAL HEIGHT	α_s	α_c	GINGIVAL HEIGHT	α_s	α_c	GINGIVAL HEIGHT	α_s	α_c
	1.8 mm			mm			mm			mm			mm		
R	31.322.236.01-2	20°	25°	-	-	-	-	-	-	-	-	-	-	-	-
NR	31.312.236.01-2			-	-	-	-	-	-	-	-	-	-	-	-

DYNAMIC 3TIBASE				
GINGIVAL HEIGHT	α_s	α_c	α_s	α_s
	CH-5mm	CH-7mm	CH-9mm	
-	-	-	-	-
-	-	-	-	-

DYNAMIC SCANBODY (LAB/CLIN)				DIGITAL ANALOG
SCANBODY	HEIGHT mm	ADAPTOR	SCREWDRIVER ADAPTOR	DIGITAL ANALOG
-	-	-	-	-
-	-	-	-	-

DYNAMIC MILLING TOOL		
DYNAMIC MILLING TOOL	SHANK	α_{di}
-	-	-
-	-	-
-	-	-

SCANBODY OP		
SCANBODY	PEEK PINS	mm
54.315.236.21-2	49.414.000.01-2	6
	49.415.000.01-2	9
	49.416.000.01-2	13

SCREWDRIVER 43.601.103.02-2

DYNAMIC SCREWS			
DYNAMIC SCREW	HIGH DYNAMIC SCREW	DYNAMIC SCREWDRIVER	SCREWDRIVER LENGTH (mm)
41.316.075.01-2	-	43.618.201.01-2	18
		43.624.201.01-2	24
		43.632.201.01-2	32

STRAIGHT SCREWS	
STRAIGHT SCREW	SCREWDRIVER Hex. 1.27
-	-

ANALOG	LAB SCANBODY
-	30.412.001.01-2

LIBRARY OPTIONS

- GH = Gingival Height α_s - Standard maximum angulation
- CH = Cement Height α_c - Captive maximum angulation
- IG = Adaptor 3mm α_s - Direct to implant maximum angulation
- R = Rotational / Non-Engaging
- NR = Non Rotational / Engaging

STANDARD DYNAMIC TIBASE															
	GINGIVAL HEIGHT	α_s	α_c	GINGIVAL HEIGHT	α_s	α_c	GINGIVAL HEIGHT	α_s	α_c	GINGIVAL HEIGHT	α_s	α_c	GINGIVAL HEIGHT	α_s	α_c
	0.6 mm			mm			mm			mm			mm		
R	31.323.245.01-2	40°	-	-	-	-	-	-	-	-	-	-	-	-	-
NR	-			-	-	-	-	-	-	-	-	-	-	-	-

DYNAMIC 3TIBASE				
GINGIVAL HEIGHT	α_s	α_c	α_s	α_s
	CH-5mm	CH-7mm	CH-9mm	
-	-	-	-	-
-	-	-	-	-

DYNAMIC SCANBODY (LAB/CLIN)				DIGITAL ANALOG
SCANBODY	HEIGHT mm	ADAPTOR	SCREWDRIVER ADAPTOR	DIGITAL ANALOG
-	-	-	-	-
-	-	-	-	-

DYNAMIC MILLING TOOL		
DYNAMIC MILLING TOOL	SHANK	α_{di}
-	-	-
-	-	-
-	-	-

DYNAMIC SCREWS			
DYNAMIC SCREW	HIGH DYNAMIC SCREW	DYNAMIC SCREWDRIVER	SCREWDRIVER LENGTH (mm)
41.314.039.01-2	-	43.618.201.01-2	18
		43.624.201.01-2	24
		43.632.201.01-2	32

STRAIGHT SCREWS	
STRAIGHT SCREW	SCREWDRIVER
-	-

ANALOG	LAB SCANBODY
-	30.413.005.01-2

LIBRARY OPTIONS

- GH = Gingival Height α_s - Standard maximum angulation
- CH = Cement Height α_c - Captive maximum angulation
- IG = Adaptor 3mm α_s - Direct to implant maximum angulation
- R = Rotational / Non-Engaging
- NR = Non Rotational / Engaging

STANDARD DYNAMIC TIBASE															
	GINGIVAL HEIGHT	α_s	α_c	GINGIVAL HEIGHT	α_s	α_c	GINGIVAL HEIGHT	α_s	α_c	GINGIVAL HEIGHT	α_s	α_c	GINGIVAL HEIGHT	α_s	α_c
	1 mm			2 mm			mm			mm			mm		
R	31.322.246.01-2	25°	-	31.322.246.02-2	25°	-	-	-	-	-	-	-	-	-	-
NR	31.312.246.01-2			31.312.246.02-2			-	-	-	-	-	-	-	-	-

DYNAMIC 3TIBASE				
	GINGIVAL HEIGHT	α_s	α_c	α_s
	mm	CH-5mm	CH-7mm	CH-9mm
R	-	-	-	-
NR	-	-	-	-

DYNAMIC SCANBODY (LAB/CLIN)				DIGITAL ANALOG
SCANBODY	HEIGHT mm	ADAPTOR	SCREWDRIVER ADAPTOR	DIGITAL ANALOG
-	-	-	-	-
-	-	-	-	-
-	-	-	-	-

DYNAMIC MILLING TOOL		
DYNAMIC MILLING TOOL	SHANK	α_{di}
-	-	-
-	-	-
-	-	-

DYNAMIC SCREWS			
DYNAMIC SCREW	HIGH DYNAMIC SCREW	DYNAMIC SCREWDRIVER	SCREWDRIVER LENGTH (mm)
41.318.080.01-2	-	43.618.201.01-2	18
		43.624.201.01-2	24
		43.632.201.01-2	32

STRAIGHT SCREWS	
STRAIGHT SCREW	SCREWDRIVER Hex. 1.20
-	-

ANALOG	LAB SCANBODY
-	30.412.001.01-2

LIBRARY OPTIONS
GH = Gingival Height α_s - Standard maximum angulation
CH = Cement Height α_c - Captive maximum angulation
IG = Adaptor 3mm α_s - Direct to implant maximum angulation
R = Rotational / Non-Engaging
NR = Non Rotational / Engaging

STANDARD DYNAMIC TIBASE															
	GINGIVAL HEIGHT	α_s	α_c	GINGIVAL HEIGHT	α_s	α_c	GINGIVAL HEIGHT	α_s	α_c	GINGIVAL HEIGHT	α_s	α_c	GINGIVAL HEIGHT	α_s	α_c
	0.3 mm			mm			mm			mm			mm		
R	31.323.247.01-2	-	-	-	40°	-	-	-	-	-	-	-	-	-	-
NR	-			-			-	-	-	-	-	-	-	-	-

DYNAMIC 3TIBASE				
	GINGIVAL HEIGHT	α_s	α_c	α_s
	mm	CH-5mm	CH-7mm	CH-9mm
-	-	-	-	-
-	-	-	-	-

DYNAMIC SCANBODY (LAB/CLIN)				DIGITAL ANALOG
SCANBODY	HEIGHT mm	ADAPTOR	SCREWDRIVER ADAPTOR	DIGITAL ANALOG
-	-	-	-	-
-	-	-	-	-
-	-	-	-	-

DYNAMIC MILLING TOOL		
DYNAMIC MILLING TOOL	SHANK	α_{di}
-	-	-
-	-	-
-	-	-

DYNAMIC SCREWS			
DYNAMIC SCREW	HIGH DYNAMIC SCREW	DYNAMIC SCREWDRIVER	SCREWDRIVER LENGTH (mm)
41.316.040.01-2	-	43.618.201.01-2	18
		43.624.201.01-2	24
		43.632.201.01-2	32

STRAIGHT SCREWS	
STRAIGHT SCREW	SCREWDRIVER
-	-

ANALOG	LAB SCANBODY
-	30.413.005.01-2

LIBRARY OPTIONS
GH = Gingival Height α_s - Standard maximum angulation
CH = Cement Height α_c - Captive maximum angulation
IG = Adaptor 3mm α_s - Direct to implant maximum angulation
R = Rotational / Non-Engaging
NR = Non Rotational / Engaging

STANDARD DYNAMIC TIBASE															
	GINGIVAL HEIGHT	α_s	α_c	GINGIVAL HEIGHT	α_s	α_c	GINGIVAL HEIGHT	α_s	α_c	GINGIVAL HEIGHT	α_s	α_c	GINGIVAL HEIGHT	α_s	α_c
	1 mm			mm			mm			mm			mm		
R	31.320.249.01-2	40°	-	-	-	-	-	-	-	-	-	-	-	-	-
NR	31.310.249.01-2														

DYNAMIC 3TIBASE

	GINGIVAL HEIGHT	α_s	α_s	α_s
	mm	CH+5mm	CH+7mm	CH+9mm
R	-	-	-	-
NR	-	-	-	-

DYNAMIC SCANBODY (LAB/CLIN) **DIGITAL ANALOG**

SCANBODY	HEIGHT mm	ADAPTOR	SCREWDRIVER ADAPTOR	DIGITAL ANALOG
52.410.128.01-2	10	50.310.249.03-2 IG-3mm	43.621.415.01-2	34.610.249.01-2
-	-			
-	-			

DYNAMIC MILLING TOOL

DYNAMIC MILLING TOOL	SHANK	α_{di}
33.315.804.01-2	3	25°
33.415.804.01-2	4	
33.615.804.01-2	6	

DYNAMIC SCREWS

DYNAMIC SCREW	HIGH DYNAMIC SCREW	DYNAMIC SCREWDRIVER	SCREWDRIVER LENGTH (mm)
41.314.080.01-2	-	43.618.201.01-2	18
		43.624.201.01-2	24
		43.632.201.01-2	32

STRAIGHT SCREWS

STRAIGHT SCREW	SCREWDRIVER Hex. 1.20
-	-

ANALOG	LAB SCANBODY
-	30.410.006.01-2

LIBRARY OPTIONS
GH = Gingival Height α_s - Standard maximum angulation
CH = Cement Height α_c - Captive maximum angulation
IG = Adaptor 3mm α_{di} - Direct to implant maximum angulation
R = Rotational / Non-Engaging
NR = Non Rotational / Engaging

STANDARD DYNAMIC TIBASE															
	GINGIVAL HEIGHT	α_s	α_c	GINGIVAL HEIGHT	α_s	α_c	GINGIVAL HEIGHT	α_s	α_c	GINGIVAL HEIGHT	α_s	α_c	GINGIVAL HEIGHT	α_s	α_c
	1mm			1.5 mm			3 mm			mm			mm		
R	31.322.251.01-2	40°	-	31.322.251.02-2	40°	-	31.322.251.04-2	25°	-	-	-	-	-	-	-
NR	31.312.251.01-2			31.312.251.02-2			31.312.251.04-2								

DYNAMIC 3TIBASE

	GINGIVAL HEIGHT	α_s	α_s	α_s
	mm	CH+5mm	CH+7mm	CH+9mm
-	-	-	-	-
-	-	-	-	-

DYNAMIC SCANBODY (LAB/CLIN) **DIGITAL ANALOG**

SCANBODY	HEIGHT mm	ADAPTOR	SCREWDRIVER ADAPTOR	DIGITAL ANALOG
-	-	-	-	-
-	-			
-	-			

DYNAMIC MILLING TOOL

DYNAMIC MILLING TOOL	SHANK	α_{di}
-	-	-
-	-	
-	-	

DYNAMIC SCREWS

DYNAMIC SCREW	HIGH DYNAMIC SCREW	DYNAMIC SCREWDRIVER	SCREWDRIVER LENGTH (mm)
41.316.064.02-2	40.316.007.01-2	43.618.201.01-2	18
		43.624.201.01-2	24
		43.632.201.01-2	32

STRAIGHT SCREWS

STRAIGHT SCREW	SCREWDRIVER
-	-

ANALOG	LAB SCANBODY
-	30.412.001.01-2

LIBRARY OPTIONS
GH = Gingival Height α_s - Standard maximum angulation
CH = Cement Height α_c - Captive maximum angulation
IG = Adaptor 3mm α_{di} - Direct to implant maximum angulation
R = Rotational / Non-Engaging
NR = Non Rotational / Engaging

STANDARD DYNAMIC TIBASE															
	GINGIVAL HEIGHT	α_s	α_c	GINGIVAL HEIGHT	α_s	α_c	GINGIVAL HEIGHT	α_s	α_c	GINGIVAL HEIGHT	α_s	α_c	GINGIVAL HEIGHT	α_s	α_c
	1 mm			mm			mm			mm			mm		
R	-	-	-	-	-	-	-	-	-	-	-	-	-	-	-
NR	-	-	-	-	-	-	-	-	-	-	-	-	-	-	-

DYNAMIC 3TIBASE				
	GINGIVAL HEIGHT	α_s	α_s	α_s
	mm	CH+5mm	CH+ 7mm	CH+ 9mm
R	-	-	-	-
NR	-	-	-	-

DYNAMIC SCANBODY (LAB/CLIN)				DIGITAL ANALOG
SCANBODY	HEIGHT mm	ADAPTOR	SCREWDRIVER ADAPTOR	DIGITAL ANALOG
-	-	-	-	-
-	-	-	-	-
-	-	-	-	-

DYNAMIC MILLING TOOL		
DYNAMIC MILLING TOOL	SHANK	α_{di}
-	-	-
-	-	-
-	-	-

DYNAMIC SCREWS			
DYNAMIC SCREW	HIGH DYNAMIC SCREW	DYNAMIC SCREWDRIVER	SCREWDRIVER LENGTH (mm)
41.318.065.01-2	40.318.003.01-2	-	-
		-	-
		-	-

STRAIGHT SCREWS	
STRAIGHT SCREW	SCREWDRIVER Hex. 1.20
40.318.003.01-2	43.601.103.02-2

ANALOG	LAB SCANBODY
-	-

MULTI-UNIT				
	GINGIVAL HEIGHT	GINGIVAL HEIGHT	GINGIVAL HEIGHT	GINGIVAL HEIGHT
	1 mm	2 mm	3 mm	4 mm
R	42.302.257.01-2	42.302.257.02-2	42.302.257.03-2	42.302.257.04-2

LIBRARY OPTIONS

GH = Gingival Height α_s - Standard maximum angulation
CH = Cement Height α_c - Captive maximum angulation
IG = Adaptor 3mm α_{di} - Direct to implant maximum angulation
R = Rotational / Non-Engaging
NR = Non Rotational / Engaging

STANDARD DYNAMIC TIBASE															
	GINGIVAL HEIGHT	α_s	α_c	GINGIVAL HEIGHT	α_s	α_c	GINGIVAL HEIGHT	α_s	α_c	GINGIVAL HEIGHT	α_s	α_c	GINGIVAL HEIGHT	α_s	α_c
	0.3 mm			mm			mm			mm			mm		
R	31.323.025.01-2	45°	30°	-	-	-	-	-	-	-	-	-	-	-	-
NR	-	-	-	-	-	-	-	-	-	-	-	-	-	-	-

DYNAMIC 3TIBASE				
	GINGIVAL HEIGHT	α_s	α_s	α_s
	0.3 mm	CH+5mm	CH+ 7mm	CH+ 9mm
R	31.323.025.21-2	30°	25°	10°
NR	-	-	-	-

DYNAMIC SCANBODY (LAB/CLIN)				DIGITAL ANALOG
SCANBODY	HEIGHT mm	ADAPTOR	SCREWDRIVER ADAPTOR	DIGITAL ANALOG
52.408.112.01-2	8	50.313.025.02-2	43.621.410.01-2	34.613.025.01-2
		50.313.025.01-2	43.624.410.01-2	
52.410.111.01-2	10			

DYNAMIC MILLING TOOL		SHANK	α_{di}
DYNAMIC MILLING TOOL	SHANK	α_{di}	
33.390.716.01-2	3	30	23.413.025.01-2
33.490.716.01-2	4		
33.690.716.01-2	6		

REFERENCE SCANBODY		
SCANBODY	PEEK PINS	mm
54.322.025.31-2	49.414.000.01-2	6
	49.415.000.01-2	9
	49.416.000.01-2	13
	CAPS	mm
	49.418.000.01-2	3.8
	49.419.000.01-2	6
49.420.000.01-2	8	

DYNAMIC SCREWS			
DYNAMIC SCREW	HIGH DYNAMIC SCREW	DYNAMIC SCREWDRIVER	SCREWDRIVER LENGTH (mm)
41.314.039.01-2	-	43.618.201.01-2	18
		43.624.201.01-2	24
		43.632.201.01-2	32

STRAIGHT SCREWS	
STRAIGHT SCREW	SCREWDRIVER Hex. 1.27
40.314.005.04-2	43.601.105.01-2

ANALOG	LAB SCANBODY
22.613.025.01-2	30.413.005.01-2

LIBRARY OPTIONS

GH = Gingival Height α_s - Standard maximum angulation
CH = Cement Height α_c - Captive maximum angulation
IG = Adaptor 3mm α_{di} - Direct to implant maximum angulation
R = Rotational / Non-Engaging
NR = Non Rotational / Engaging

STANDARD DYNAMIC TIBASE															
	GINGIVAL HEIGHT	α_s	α_c	GINGIVAL HEIGHT	α_s	α_c	GINGIVAL HEIGHT	α_s	α_c	GINGIVAL HEIGHT	α_s	α_c	GINGIVAL HEIGHT	α_s	α_c
	0.5 mm			mm			mm			mm			mm		
R	31.320.260.01-2	40°	-	-	-	-	-	-	-	-	-	-	-	-	-
NR	31.310.260.01-2		-	-	-	-	-	-	-	-	-	-	-	-	-

DYNAMIC 3TIBASE				
	GINGIVAL HEIGHT	α_s	α_s	α_s
	mm	CH-5mm	CH-7mm	CH-9mm
R	-	-	-	-
NR	-	-	-	-

DYNAMIC SCANBODY (LAB/CLIN)				DIGITAL ANALOG
SCANBODY	HEIGHT mm	ADAPTOR	SCREWDRIVER ADAPTOR	DIGITAL ANALOG
52.410.103.01-2	10	50.310.207.03-2 IG-3mm	43.621.410.01-2 43.624.410.01-2	34.610.260.01-2
52.412.103.01-2	12			

DYNAMIC MILLING TOOL		
DYNAMIC MILLING TOOL	SHANK	α_{di}
33.345.856.01-2	3	25°
33.445.856.01-2	4	
33.645.856.01-2	6	

SCANBODY OP		
SCANBODY	PEEK PINS	mm
54.315.207.21-2	49.414.000.01-2	6
	49.415.000.01-2	9
	49.416.000.01-2	13

SCREWDRIVER 43.601.107.01-2

DYNAMIC SCREWS			
DYNAMIC SCREW	HIGH DYNAMIC SCREW	DYNAMIC SCREWDRIVER	SCREWDRIVER LENGTH (mm)
41.316.066.01-2	-	43.618.201.01-2	18
		43.624.201.01-2	24
		43.632.201.01-2	32

STRAIGHT SCREWS	
STRAIGHT SCREW	SCREWDRIVER Hex. 1.20
-	-

ANALOG	LAB SCANBODY
-	30.410.006.01-2

MULTI-UNIT				
	GINGIVAL HEIGHT	GINGIVAL HEIGHT	GINGIVAL HEIGHT	GINGIVAL HEIGHT
	1 mm	2 mm	3 mm	4 mm
R	42.302.207.01-2	42.302.207.02-2	42.302.207.03-2	42.302.207.04-2

LIBRARY OPTIONS
GH = Gingival Height α_s - Standard maximum angulation
CH = Cement Height α_c - Captive maximum angulation
IG = Adaptor 3mm α_{di} - Direct to implant maximum angulation
R = Rotational / Non-Engaging
NR = Non Rotational / Engaging

STANDARD DYNAMIC TIBASE															
	GINGIVAL HEIGHT	α_s	α_c	GINGIVAL HEIGHT	α_s	α_c	GINGIVAL HEIGHT	α_s	α_c	GINGIVAL HEIGHT	α_s	α_c	GINGIVAL HEIGHT	α_s	α_c
	0.5 mm			mm			mm			mm			mm		
R	31.323.261.01-2	40°	-	-	-	-	-	-	-	-	-	-	-	-	-
NR	31.313.261.01-2		-	-	-	-	-	-	-	-	-	-	-	-	-

DYNAMIC 3TIBASE				
	GINGIVAL HEIGHT	α_s	α_s	α_s
	mm	CH-5mm	CH-7mm	CH-9mm
R	-	-	-	-
NR	-	-	-	-

DYNAMIC SCANBODY (LAB/CLIN)				DIGITAL ANALOG
SCANBODY	HEIGHT mm	ADAPTOR	SCREWDRIVER ADAPTOR	DIGITAL ANALOG
52.410.103.01-2	10	50.310.207.03-2 IG-3mm	43.621.410.01-2 43.624.410.01-2	34.613.261.01-2
52.412.103.01-2	12			

DYNAMIC MILLING TOOL		
DYNAMIC MILLING TOOL	SHANK	α_{di}
33.345.856.01-2	3	25°
33.445.856.01-2	4	
33.645.856.01-2	6	

SCANBODY OP		
SCANBODY	PEEK PINS	mm
54.315.207.21-2	49.414.000.01-2	6
	49.415.000.01-2	9
	49.416.000.01-2	13

SCREWDRIVER 43.601.107.01-2

DYNAMIC SCREWS			
DYNAMIC SCREW	HIGH DYNAMIC SCREW	DYNAMIC SCREWDRIVER	SCREWDRIVER LENGTH (mm)
41.316.066.01-2	-	43.618.201.01-2	18
		43.624.201.01-2	24
		43.632.201.01-2	32

STRAIGHT SCREWS	
STRAIGHT SCREW	SCREWDRIVER Hex. 1.20
-	-

ANALOG	LAB SCANBODY
-	30.413.004.01-2

MULTI-UNIT				
	GINGIVAL HEIGHT	GINGIVAL HEIGHT	GINGIVAL HEIGHT	GINGIVAL HEIGHT
	1 mm	2 mm	3 mm	4 mm
R	42.302.207.01-2	42.302.207.02-2	42.302.207.03-2	42.302.207.04-2

LIBRARY OPTIONS
GH = Gingival Height α_s - Standard maximum angulation
CH = Cement Height α_c - Captive maximum angulation
IG = Adaptor 3mm α_{di} - Direct to implant maximum angulation
R = Rotational / Non-Engaging
NR = Non Rotational / Engaging

STANDARD DYNAMIC TIBASE															
	GINGIVAL HEIGHT	α_s	α_c	GINGIVAL HEIGHT	α_s	α_c	GINGIVAL HEIGHT	α_s	α_c	GINGIVAL HEIGHT	α_s	α_c	GINGIVAL HEIGHT	α_s	α_c
	0.5 mm			mm			mm			mm			mm		
R	31.324.262.01-2	40°	-	-	-	-	-	-	-	-	-	-	-	-	-
NR	31.314.262.01-2		-	-	-	-	-	-	-	-	-	-	-	-	-

DYNAMIC 3TIBASE

	GINGIVAL HEIGHT	α_s	α_s	α_s
	mm	CH+5mm	CH+7mm	CH+9mm
R	-	-	-	-
NR	-	-	-	-

DYNAMIC SCANBODY (LAB/CLIN) DIGITAL ANALOG

SCANBODY	HEIGHT mm	ADAPTOR	SCREWDRIVER ADAPTOR	DIGITAL ANALOG
52.410.103.01-2	10	50.310.207.03-2 IG-3mm	43.621.410.01-2 43.624.410.01-2	34.614.262.01-2
52.412.103.01-2	12			

DYNAMIC MILLING TOOL

DYNAMIC MILLING TOOL	SHANK	α_{di}
33.345.856.01-2	3	25°
33.445.856.01-2	4	
33.645.856.01-2	6	

SCANBODY OP

SCANBODY	PEEK PINS	mm
54.315.207.21-2	49.414.000.01-2	6
	49.415.000.01-2	9
	49.416.000.01-2	13

SCREWDRIVER 43.601.107.01-2

DYNAMIC SCREWS

DYNAMIC SCREW	HIGH DYNAMIC SCREW	DYNAMIC SCREWDRIVER	SCREWDRIVER LENGTH (mm)
41.316.066.01-2	-	43.618.201.01-2	18
		43.624.201.01-2	24
		43.632.201.01-2	32

STRAIGHT SCREWS

STRAIGHT SCREW	SCREWDRIVER Hex. 1.20
-	-

ANALOG LAB SCANBODY

-	30.414.008.01-2
---	-----------------

MULTI-UNIT

	GINGIVAL HEIGHT	GINGIVAL HEIGHT	GINGIVAL HEIGHT	GINGIVAL HEIGHT
	1 mm	2 mm	3 mm	4 mm
R	42.302.207.01-2	42.302.207.02-2	42.302.207.03-2	42.302.207.04-2

LIBRARY OPTIONS
GH = Gingival Height α_s - Standard maximum angulation
CH = Cement Height α_c - Captive maximum angulation
IG = Adaptor 3mm α_{di} - Direct to implant maximum angulation
R = Rotational / Non-Engaging
NR = Non Rotational / Engaging

STANDARD DYNAMIC TIBASE															
	GINGIVAL HEIGHT	α_s	α_c	GINGIVAL HEIGHT	α_s	α_c	GINGIVAL HEIGHT	α_s	α_c	GINGIVAL HEIGHT	α_s	α_c	GINGIVAL HEIGHT	α_s	α_c
	mm			mm			mm			mm			mm		
R	-	-	-	-	-	-	-	-	-	-	-	-	-	-	-
NR	-	-	-	-	-	-	-	-	-	-	-	-	-	-	-

DYNAMIC 3TIBASE

	GINGIVAL HEIGHT	α_s	α_s	α_s
	0.3 mm	CH+5mm	CH+7mm	CH+9mm
R	31.323.264.21-2	25°	25°	25°
NR	-			

DYNAMIC SCANBODY (LAB/CLIN) DIGITAL ANALOG

SCANBODY	HEIGHT mm	ADAPTOR	SCREWDRIVER ADAPTOR	DIGITAL ANALOG
-	-	-	-	-
-	-			
-	-			

DYNAMIC MILLING TOOL

DYNAMIC MILLING TOOL	SHANK	α_{di}
-	-	-
-	-	-
-	-	-

DYNAMIC SCREWS

DYNAMIC SCREW	HIGH DYNAMIC SCREW	DYNAMIC SCREWDRIVER	SCREWDRIVER LENGTH (mm)
41.314.044.02-2	-	43.618.201.01-2	18
		43.624.201.01-2	24
		43.632.201.01-2	32

STRAIGHT SCREWS

STRAIGHT SCREW	SCREWDRIVER
-	-

ANALOG LAB SCANBODY

-	-
---	---

LIBRARY OPTIONS
GH = Gingival Height α_s - Standard maximum angulation
CH = Cement Height α_c - Captive maximum angulation
IG = Adaptor 3mm α_{di} - Direct to implant maximum angulation
R = Rotational / Non-Engaging
NR = Non Rotational / Engaging

STANDARD DYNAMIC TIBASE															
	GINGIVAL HEIGHT	α_s	α_c	GINGIVAL HEIGHT	α_s	α_c	GINGIVAL HEIGHT	α_s	α_c	GINGIVAL HEIGHT	α_s	α_c	GINGIVAL HEIGHT	α_s	α_c
	0.5 mm			mm			mm			mm			mm		
R	31.320.266.01-2	35°	-	-	-	-	-	-	-	-	-	-	-	-	-
NR	31.310.266.01-2		-	-	-	-	-	-	-	-	-	-	-	-	-

DYNAMIC 3TIBASE				
	GINGIVAL HEIGHT	α_s	α_s	α_s
	mm	CH-5mm	CH-7mm	CH-9mm
R	-	-	-	-
NR	-	-	-	-

DYNAMIC SCANBODY (LAB/CLIN)				DIGITAL ANALOG
SCANBODY	HEIGHT mm	ADAPTOR	SCREWDRIVER ADAPTOR	DIGITAL ANALOG
-	-	-	-	-
-	-	-	-	-
-	-	-	-	-

DYNAMIC MILLING TOOL		
DYNAMIC MILLING TOOL	SHANK	α_{di}
-	-	-
-	-	-
-	-	-

DYNAMIC SCREWS			
DYNAMIC SCREW	HIGH DYNAMIC SCREW	DYNAMIC SCREWDRIVER	SCREWDRIVER LENGTH (mm)
41.320.068.01-2	-	43.618.201.01-2	18
		43.624.201.01-2	24
		43.632.201.01-2	32

STRAIGHT SCREWS	
STRAIGHT SCREW	SCREWDRIVER Hex. 1.20
-	-

ANALOG	LAB SCANBODY
-	30.410.006.01-2

LIBRARY OPTIONS
GH = Gingival Height α_s - Standard maximum angulation
CH = Cement Height α_c - Captive maximum angulation
IG = Adaptor 3mm α_s - Direct to implant maximum angulation
R = Rotational / Non-Engaging
NR = Non Rotational / Engaging

STANDARD DYNAMIC TIBASE															
	GINGIVAL HEIGHT	α_s	α_c	GINGIVAL HEIGHT	α_s	α_c	GINGIVAL HEIGHT	α_s	α_c	GINGIVAL HEIGHT	α_s	α_c	GINGIVAL HEIGHT	α_s	α_c
	0.5 mm			mm			mm			mm			mm		
R	31.322.267.01-2	40°	-	-	-	-	-	-	-	-	-	-	-	-	-
NR	31.312.267.01-2		-	-	-	-	-	-	-	-	-	-	-	-	-

DYNAMIC 3TIBASE				
	GINGIVAL HEIGHT	α_s	α_s	α_s
	mm	CH-5mm	CH-7mm	CH-9mm
-	-	-	-	-
-	-	-	-	-

DYNAMIC SCANBODY (LAB/CLIN)				DIGITAL ANALOG
SCANBODY	HEIGHT mm	ADAPTOR	SCREWDRIVER ADAPTOR	DIGITAL ANALOG
-	-	-	-	-
-	-	-	-	-
-	-	-	-	-

DYNAMIC MILLING TOOL		
DYNAMIC MILLING TOOL	SHANK	α_{di}
-	-	-
-	-	-
-	-	-

DYNAMIC SCREWS			
DYNAMIC SCREW	HIGH DYNAMIC SCREW	DYNAMIC SCREWDRIVER	SCREWDRIVER LENGTH (mm)
41.320.068.01-2	-	43.618.201.01-2	18
		43.624.201.01-2	24
		43.632.201.01-2	32

STRAIGHT SCREWS	
STRAIGHT SCREW	SCREWDRIVER TORX T6
40.320.007.02-2	43.601.107.01-2

ANALOG	LAB SCANBODY
-	30.412.001.01-2

LIBRARY OPTIONS
GH = Gingival Height α_s - Standard maximum angulation
CH = Cement Height α_c - Captive maximum angulation
IG = Adaptor 3mm α_s - Direct to implant maximum angulation
R = Rotational / Non-Engaging
NR = Non Rotational / Engaging

STANDARD DYNAMIC TIBASE															
	GINGIVAL HEIGHT	α_s	α_c	GINGIVAL HEIGHT	α_s	α_c	GINGIVAL HEIGHT	α_s	α_c	GINGIVAL HEIGHT	α_s	α_c	GINGIVAL HEIGHT	α_s	α_c
	0.5 mm			mm			mm			mm			mm		
R	31.320.268.01-2	45°	-	-	-	-	-	-	-	-	-	-	-	-	-
NR	31.310.268.01-2			-	-	-	-	-	-	-	-	-	-	-	-

DYNAMIC 3TIBASE				
	GINGIVAL HEIGHT	α_s	α_s	α_s
	mm	CH-5mm	CH- 7mm	CH- 9mm
R	-	-	-	-
NR	-	-	-	-

DYNAMIC SCANBODY (LAB/CLIN)				DIGITAL ANALOG
SCANBODY	HEIGHT mm	ADAPTOR	SCREWDRIVER ADAPTOR	DIGITAL ANALOG
-	-	-	-	-
-	-			
-	-			

DYNAMIC MILLING TOOL		
DYNAMIC MILLING TOOL	SHANK	α_{di}
-	-	-
-	-	-
-	-	-

DYNAMIC SCREWS			
DYNAMIC SCREW	HIGH DYNAMIC SCREW	DYNAMIC SCREWDRIVER	SCREWDRIVER LENGTH (mm)
41.320.068.01-2	-	43.618.201.01-2	18
		43.624.201.01-2	24
		43.632.201.01-2	32

STRAIGHT SCREWS	
STRAIGHT SCREW	SCREWDRIVER Hex. 1.20
-	-

ANALOG	LAB SCANBODY
-	30.413.002.01-2

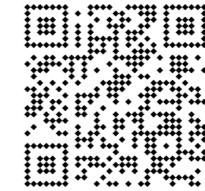

This printed version is probably outdated and may not include all products or compatibilities.

Access and download the latest version of this catalogue www.dynamicabutment.com

LIBRARY OPTIONS	
GH = Gingival Height	α_s - Standard maximum angulation
CH = Cement Height	α_c - Captive maximum angulation
IG = Adaptor 3mm	α_d - Direct to implant maximum angulation
	R = Rotational / Non-Engaging
	NR = Non Rotational / Engaging

DAS LIBRARIES

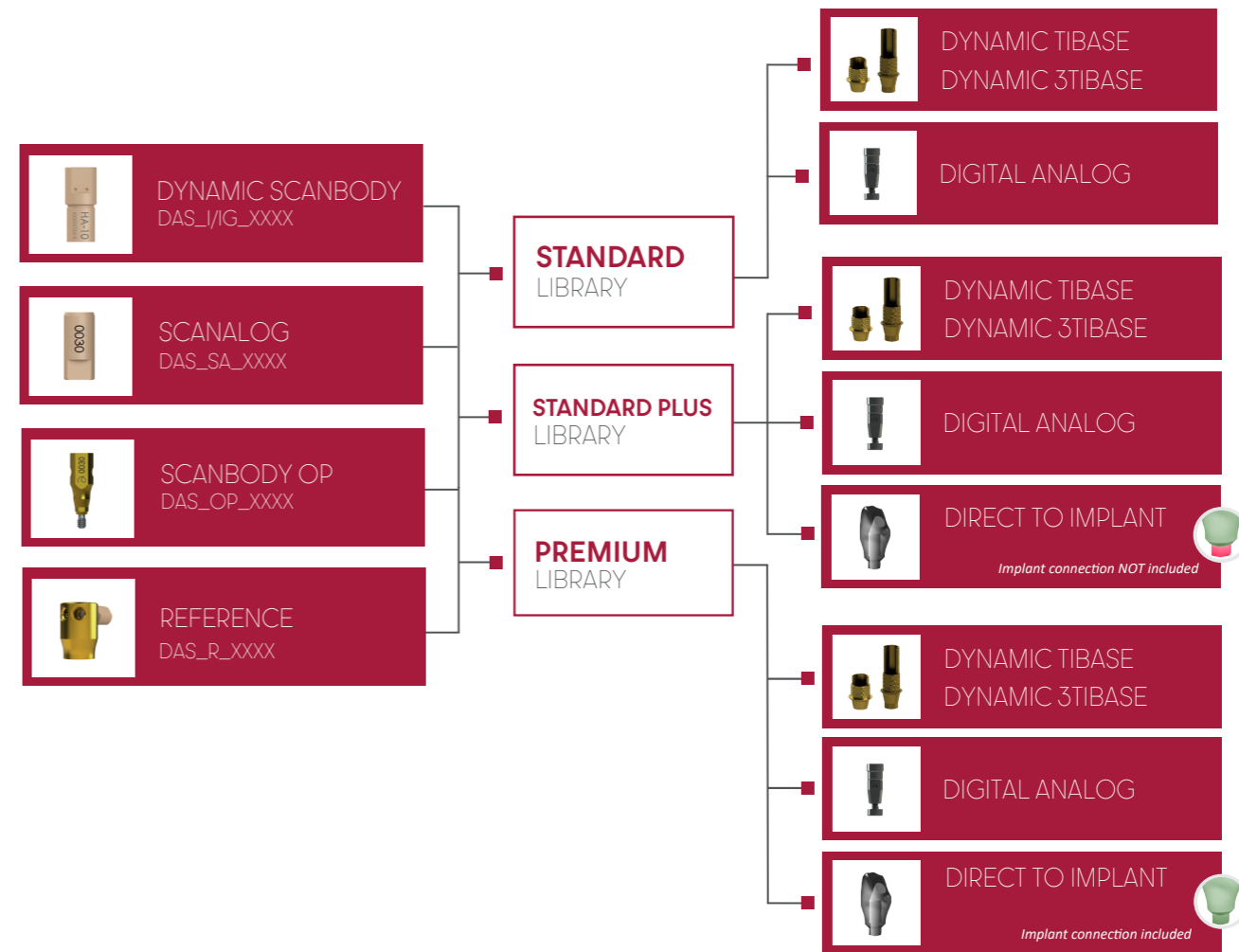
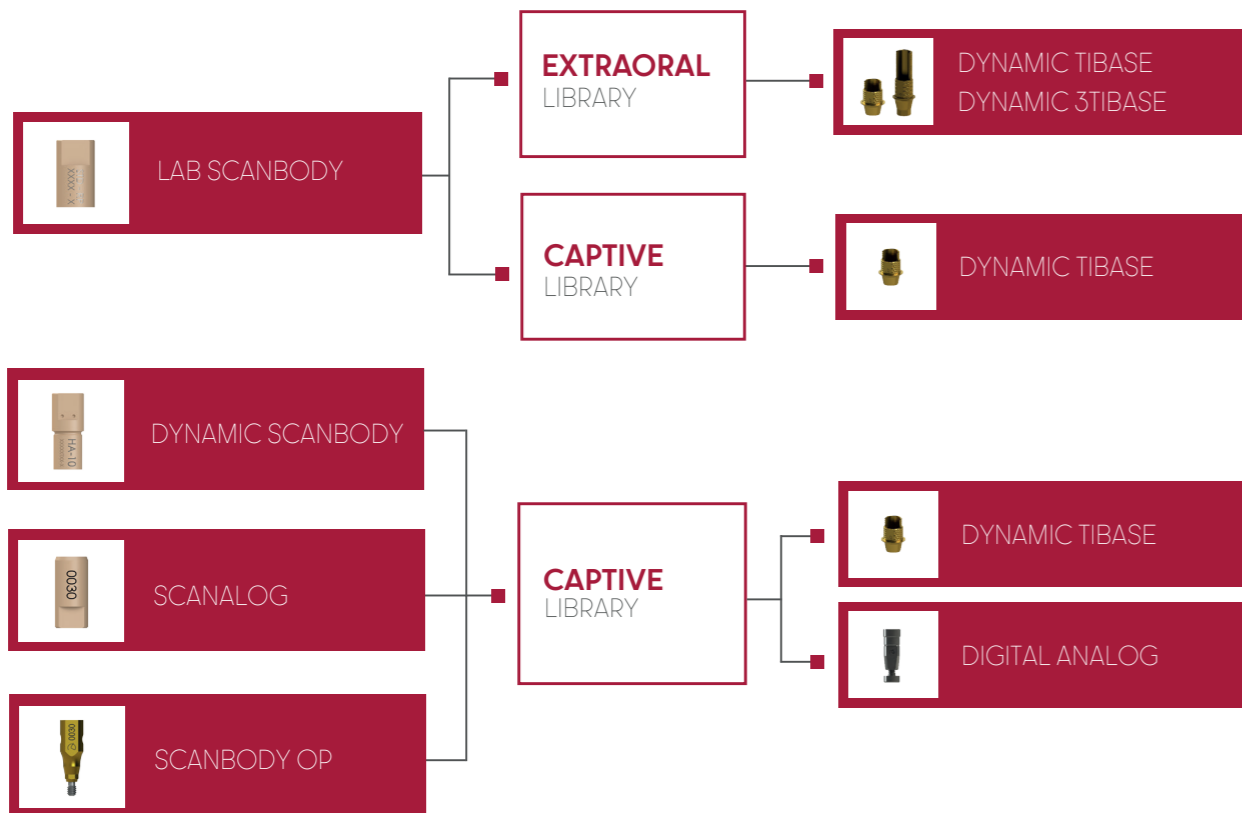

DAS MU PREMIUM LIBRARY



MU SCANBODY
 DAS_MU_4.5_XXXX_PREMIUM
 DAS_MU_8_XXXX_PREMIUM
 DAS_MU_DS8_XXXX_PREMIUM
 DAS_MU_R_XXXX_PREMIUM



MU SCANALOG
 DAS_MU_SA_XXXX_PREMIUM



DYNAMIC SCANBODY
 DAS_MU_I/IG_XXXX_PREMIUM



SCANBODY OP
 DAS_MU_OP_XXXX_PREMIUM

DYNAMIC SCREWS TECHNICAL SPECIFICATIONS

REFERENCE	METRIC	TORQUE	TOTAL LENGTH	THREAD LENGTH	A LENGTH	B LENGTH	C LENGTH	HEAD DIAMETER	SEAT	ANGLE	THREAD ENTRY	CONNECTION
41312.078.01-2	1.2	15 Ncm	7.8	2.65	6	6.55	1.25	2.3	conical	45°	45° Chamfer	HEXALOBULAR 1.70
41314.039.01-2	1.4	15 Ncm	3.9	1.8	2.1	-	1.8	2.4	straight	-	45° Chamfer	
41314.040.01-2	1.4	15 Ncm	4	1.85	2	2.78	1.22	2.3	conical	30°	45° Chamfer	
41314.040.02-2	1.4	15 Ncm	4	1.7	2.25	2.7	1.3	2.3	conical	45°	45° Chamfer	
41314.043.01-2	1.4	15 Ncm	4.3	1.8	2.03	2.9	1.4	2.3	conical	35°	45° Chamfer	
41314.044.01-2	1.4	15 Ncm	4.4	2.15	2.73	3	1.4	2.3	conical	60°	45° Chamfer	
41314.044.02-2	1.4	15 Ncm	4.4	2	2.6	-	1.8	2.3	straight	-	45° Chamfer	
41314.045.01-2	1.4	15 Ncm	4.5	2.3	2.5	3.28	1.22	2.3	conical	30°	45° Chamfer	
41314.046.01-2	1.4	15 Ncm	4.6	2.5	4.6	3.17	1.43	2.3	conical	35°	45° Chamfer	
41314.052.01-2	1.4	15 Ncm	5.2	2.9	3.4	-	1.8	2.3	straight	-	45° Chamfer	
41314.064.01-2	1.4	15 Ncm	6.4	2.2	4.21	5.15	1.25	2.3	conical	25°	45° Chamfer	
41314.067.01-2	1.4	15 Ncm	6.7	2.31	5	5.45	1.25	2.3	conical	45°	45° Chamfer	
41314.067.02-2	1.4	15 Ncm	6.7	2.5	4.71	5.5	1.2	2.3	conical	35°	45° Chamfer	
41314.070.01-2	1.4	15 Ncm	7	2.3	5.39	5.65	1.61	2.3	conical	60°	45° Chamfer	
41314.074.01-2	1.4	15 Ncm	7.4	3.55	5	5.99	1.41	2.3	conical	25°	45° Chamfer	
41314.076.01-2	1.4	15 Ncm	7.6	2.4	5.9	6.35	1.25	2.3	conical	45°	45° Chamfer	
41314.080.01-2	1.4	15 Ncm	8	2.1	4.96	6.8	1.2	2.3	conical	15°	45° Chamfer	
41314.084.01-2	1.4	15 Ncm	8.4	2.5	5.92	6.85	1.55	2.3	conical	35°	45° Chamfer	
41314.105.01-2	1.4	15 Ncm	10.5	2.31	5	5.45	5.05	2.3	conical	45°	45° Chamfer	
41315.078.01-2	No-80	15 Ncm	7.8	2.45	5.77	6	1.8	2.3	conical	65°	45° Chamfer	
41315.040.01-2	1.6	20 Ncm	4	2.07	2.3	2.47	1.53	2.3	conical	65°	45° Chamfer	
41316.044.01-2	1.6	20 Ncm	4.4	2.5	2.9	-	1.5	2.3	straight	-	Semi-sphere	
41316.048.01-2	1.6	20 Ncm	4.8	2.4	2.93	1.87	1.3	2.3	conical	45°	45° Chamfer	
41316.048.02-2	1.6	20 Ncm	4.8	2.4	3	3.58	1.22	2.3	conical	31°	45° Chamfer	
41316.055.01-2	1.6	20 Ncm	5.5	2.4	2.85	4.2	1.3	2.3	conical	23°	45° Chamfer	
41316.059.01-2	1.6	20 Ncm	5.9	3	4.4	-	1.5	2.3	straight	-	Semi-sphere	
41316.064.01-2	1.6	20 Ncm	6.4	3.15	4.7	5	1.4	2.3	conical	60°	45° Chamfer	

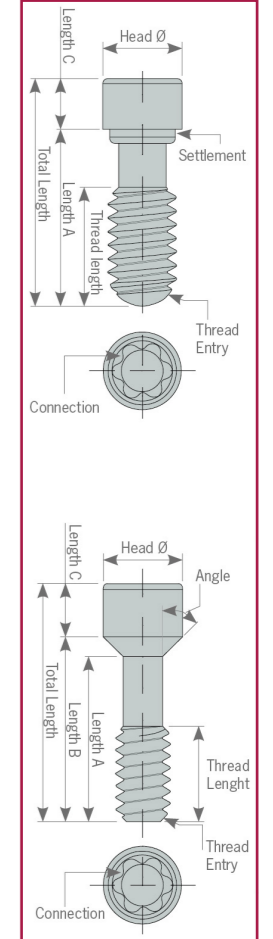

DYNAMIC SCREWS TECHNICAL SPECIFICATIONS

REFERENCE	METRIC	TORQUE	TOTAL LENGTH	THREAD LENGTH	A LENGTH	B LENGTH	C LENGTH	HEAD DIAMETER	SEAT	ANGLE	THREAD ENTRY	CONNECTION
41.316.066.01-2	1.6	20 N-cm	6.6	1.9	4.7	5.2	1.9	2.3	conical	45°	45° Chamfer	HEXALOBULAR 170
41.316.071.01-2	1.6	20 N-cm	7.1	2.8	5.2	5.53	1.57	2.3	conical	60°	45° Chamfer	
41.316.072.01-2	1.6	20 N-cm	7.2	3.5	5.2	5.85	1.35	2.3	conical	30°	45° Chamfer	
41.316.073.01-2	1.6	20 N-cm	7.3	2.2	4.87	5.56	1.74	2.3	conical	35°	45° Chamfer	
41.316.074.01-2	1.6	20 N-cm	7.4	2.7	5.5	6	1.4	2.3	conical	45°	45° Chamfer	
41.316.076.01-2	1.6	20 N-cm	7.6	3.6	6.1	-	1.5	2.3	straight	-	Semi-sphere	
41.316.078.01-2	1.6	20 N-cm	7.8	2	5.36	7.03	0.81	2.3	conical	15°	45° Chamfer	
41.316.079.01-2	1.6	20 N-cm	7.9	2.30	5.42	6.60	1.3	2.3	conical	20°	45° Chamfer	
41.316.079.02-2	1.6	20 N-cm	7.9	3.9	6.3	-	1.6	2.3	straight	-	45° Chamfer	
41.316.080.01-2	1.6	20 N-cm	8	3.14	6.3	6.51	1.49	2.3	conical	60°	45° Chamfer	
41.316.081.01-2	1.6	20 N-cm	8.1	3	6.35	6.72	1.38	2.3	conical	45°	45° Chamfer	
41.316.084.01-2	1.6	20 N-cm	8.4	3.5	6.8	-	1.6	2.3	straight	-	Semi-sphere	
41.316.084.02-2	1.6	20 N-cm	8.4	2.7	5.85	6.85	1.55	2.3	conical	30°	45° Chamfer	
41.316.086.01-2	1.6	20 N-cm	8.6	3	7.2	-	1.4	2.3	straight	-	45° Chamfer	
41.316.094.01-2	1.6	20 N-cm	9.4	2.9	7.65	8	1.4	2.3	conical	45°	45° Chamfer	
41.316.108.01-2	1.6	20 N-cm	10.8	2	5.36	7.03	0.81	2.3	conical	15°	45° Chamfer	
41.316.115.01-2	1.6	20 N-cm	11.5	3.5	5.2	5.85	6.3	2.3	conical	30°	45° Chamfer	
41.316.118.01-2	1.6	20 N-cm	11.8	3.6	6.1	-	5.7	2.3	straight	-	Semi-sphere	
41.316.124.01-2	1.6	20 N-cm	12.4	2.2	4.74	5.56	5.24	2.3	conical	35°	45° Chamfer	
41.316.132.01-2	1.6	20 N-cm	13.2	2.9	7.62	8	5.2	2.3	conical	45°	45° Chamfer	
41.317.040.01-2	N1-72	25 N-cm	4	2.1	2.5	-	1.5	2.3	straight	-	45° Chamfer	
41.317.041.01-2	N1-72	25 N-cm	4.1	1.9	2.3	2.67	1.43	2.3	conical	55°	45° Chamfer	
41.317.065.01-2	N1-72	25 N-cm	6.5	2.4	4.7	5.18	1.33	2.3	conical	45°	45° Chamfer	
41.317.070.01-2	N1-72	25 N-cm	7	2.2	4.96	5.8	1.2	2.3	conical	30°	45° Chamfer	
41.317.071.01-2	N1-72	25 N-cm	7.1	2.5	5.56	5.65	1.45	2.3	conical	70°	45° Chamfer	
41.317.072.01-2	N1-72	25 N-cm	7.2	2.5	5.5	5.77	1.43	2.3	conical	60°	45° Chamfer	
41.317.073.01-2	N1-72	25 N-cm	7.3	2.5	5.5	5.77	1.53	2.3	conical	60°	45° Chamfer	
41.317.106.01-2	N1-72	25 N-cm	10.6	2.6	5.54	5.65	4.95	2.3	conical	70°	Semi-sphere	
41.318.043.01-2	1.8	25 N-cm	4.3	2	2.52	2.7	1.6	2.3	conical	55°	45° Chamfer	

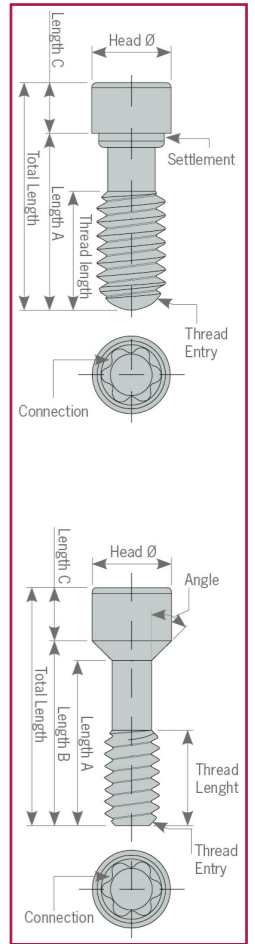

DYNAMIC SCREWS TECHNICAL SPECIFICATIONS

REFERENCE	METRIC	TORQUE	TOTAL LENGTH	THREAD LENGTH	A LENGTH	B LENGTH	C LENGTH	HEAD DIAMETER	SEAT	ANGLE	THREAD ENTRY	CONNECTION
41.318.044.01-2	1.8	25 N-cm	4.4	2.75	3	-	1.4	2.3	straight	-	Semi-sphere	HEXALOBULAR 170
41.318.045.01-2	1.8	25 N-cm	4.5	2.3	2.81	2.9	1.6	2.3	conical	70°	45° Chamfer	
41.318.048.01-2	1.8	25 N-cm	4.8	2.8	3.22	3.65	1.15	2.3	conical	30°	Semi-sphere	
41.318.051.01-2	1.8	25 N-cm	5.1	2.7	3.55	3.7	1.4	2.3	conical	60°	45° Chamfer	
41.318.051.02-2	1.8	25 N-cm	5.1	2.7	3.55	3.7	1.4	2.3	conical	45°	45° Chamfer	
41.318.064.01-2	1.8	25 N-cm	6.4	3.45	4.73	5.1	1.3	2.3	conical	35°	45° Chamfer	
41.318.065.01-2	1.8	25 N-cm	6.5	2.8	5	-	1.5	2.3	straight	-	Semi-sphere	
41.318.067.01-2	1.8	25 N-cm	6.7	2.35	5	5.4	1.3	2.3	conical	45°	45° Chamfer	
41.318.068.01-2	1.8	25 N-cm	6.8	4	5.25	5.4	1.4	2.3	conical	60°	45° Chamfer	
41.318.071.01-2	1.8	25 N-cm	7.1	2.6	5.56	5.65	1.45	2.3	conical	70°	45° Chamfer	
41.318.074.01-2	1.8	25 N-cm	7.4	3.8	5.8	6.03	1.6	2.3	conical	50°	45° Chamfer	
41.318.075.01-2	1.8	25 N-cm	7.5	3.3	6.1	-	1.4	2.3	straight	-	Semi-sphere	
41.318.076.01-2	1.8	25 N-cm	7.6	2.52	5.8	6.2	1.4	2.3	conical	45°	45° Chamfer	
41.318.077.02-2	1.8	25 N-cm	7.7	2	6.09	6.35	1.35	2.3	conical	60°	45° Chamfer	
41.318.080.01-2	1.8	25 N-cm	8	4	6.5	-	1.5	2.3	straight	-	45° Chamfer	
41.318.083.01-2	1.8	25 N-cm	8.3	4.25	6.79	6.95	1.35	2.3	conical	60°	45° Chamfer	
41.320.038.01-2	2	25 N-cm	3.81	1.6	3.25	2.35	1.39	2.35	conical	70°	20° Chamfer	
41.320.044.01-2	2	25 N-cm	4.4	2.45	2.45	3.1	1.3	2.3	conical	45°	45° Chamfer	
41.320.047.01-2	2	25 N-cm	4.7	3	3.3	-	1.4	2.3	straight	-	Semi-sphere	
41.320.048.01-2	2	25 N-cm	4.8	2.7	3.3	3.4	1.4	2.3	conical	60°	45° Chamfer	
41.320.050.01-2	2	25 N-cm	5	2.8	3.39	3.6	1.4	2.3	conical	30°	Semi-sphere	
41.320.051.01-2	2	25 N-cm	5.1	3.1	3.6	-	1.5	2.3	straight	-	Semi-sphere	
41.320.060.01-2	2	25 N-cm	6	2.7	4.5	-	1.5	2.3	straight	-	Semi-sphere	
41.320.065.01-2	2	25 N-cm	6.5	2.7	5	-	1.5	2.3	straight	-	45° Chamfer	
41.320.067.01-2	2	25 N-cm	6.7	2.3	3.65	5.68	1.02	2.58	conical	15°	45° Chamfer	
41.320.068.01-2	2	25 N-cm	6.8	4.4	5.3	5.4	1.4	2.3	conical	60°	45° Chamfer	

DYNAMIC SCREWS TECHNICAL SPECIFICATIONS

REFERENCE	METRIC	TORQUE	TOTAL LENGTH	THREAD LENGTH	A LENGTH	B LENGTH	C LENGTH	HEAD DIAMETER	SEAT	ANGLE	THREAD ENTRY	CONNECTION
41.320.070.01-2	2	25 N·cm	7	3	5,6	-	1,4	2,3	straight	-	Semi-sphere	Hexalobular 1,70
41.320.074.01-2	2	25 N·cm	7,4	3,3	6	-	1,4	2,3	straight	-	Semi-sphere	
41.320.075.01-2	2	25 N·cm	7,5	2,75	5,93	6,18	1,32	2,3	conical	35°	45° Chamfer	
41.320.079.01-2	2	25 N·cm	7,9	3,3	6,33	6,5	1,4	2,3	conical	45°	45° Chamfer	
41.320.082.01-2	2	25 N·cm	8,2	4,7	6,7	-	1,5	2,4	straight	-	Semi-sphere	
41.320.090.01-2	2	25 N·cm	9	4	7,5	-	1,5	2,3	straight	-	Semi-sphere	
41.320.094.01-2	2	25 N·cm	9,4	3	7,85	8	1,4	2,3	conical	45°	45° Chamfer	
41.320.117.01-2	2	25 N·cm	11,7	2,75	5,9	6,18	5,52	2,3	conical	35°	Semi-sphere	
41.320.125.01-2	2	25 N·cm	12,5	3,3	6,33	6,5	6	2,3	conical	45°	45° Chamfer	
41.320.129.01-2	2	25 N·cm	12,9	4,7	6,7	-	6,2	2,4	straight	-	Semi-sphere	
41.320.137.01-2	2	25 N·cm	13,7	4	12,2	-	1,5	2,3	straight	-	Semi-sphere	
41.325.054.01-2	2,5	25 N·cm	5,4	3,8	4,1	-	1,3	2,85	straight	-	Semi-sphere	
41.325.067.01-2	2,5	25 N·cm	6,7	4,6	5,1	-	1,6	2,85	straight	-	Semi-sphere	

STRAIGHT SCREWS TECHNICAL SPECIFICATIONS

REFERENCE	METRIC	TORQUE	TOTAL LENGTH	THREAD LENGTH	A LENGTH	B LENGTH	C LENGTH	HEAD DIAMETER	SEAT	ANGLE	THREAD ENTRY	CONNECTION
40.312.003.01-2	1,2	15 N·cm	7,85	2,7	6,19	6,55	1,3	1,9	conical	45°	45° Chamfer	Hex 1,20
40.314.003.03-2	1,4	15 N·cm	7,6	2,4	6,05	6,3	1,3	1,9	conical	45°	45° Chamfer	Hex 1,20
40.314.003.04-2	1,4	15 N·cm	7,5	2,5	5,45	5,7	1,8	1,85	conical	45°	45° Chamfer	Hex 1,20
40.314.004.01-2	1,4	15 N·cm	6,3	1,7	4,6	5,1	1,2	2,1	conical	25°	30° Chamfer	Hex 1,25
40.314.004.02-2	1,4	15 N·cm	8,4	2,5	5,99	6,7	1,7	2	conical	35°	45° Chamfer	Hex 1,25
40.314.004.03-2	1,4	15 N·cm	4,3	1,8	2,3	-	2	2	straight	-	45° Chamfer	Hex 1,25
40.314.005.01-2	1,4	15 N·cm	7,6	3,55	5,17	6	1,6	2,15	conical	25°	45° Chamfer	Hex 1,27
40.314.005.02-2	1,4	15 N·cm	7,5	2,5	5,5	5,7	1,7	2,1	conical	60°	45° Chamfer	Hex 1,27
40.314.005.04-2	1,4	15 N·cm	4	1,70	2,25	-	1,75	2,10	straight	-	45° Chamfer	Hex 1,27
40.314.007.01-2	1,4	15 N·cm	4	1,8	2,01	2,8	1,2	2,2	conical	35°	45° Chamfer	Torx T6
40.314.007.02-2	1,4	15 N·cm	7	2,1	4,75	2,25	0,8	2,1	conical	15°	45° Chamfer	Torx T6
40.314.008.01-2	1,4	15 N·cm	3,5	1,8	2,1	-	1,4	2	straight	-	45° Chamfer	Unigrip
40.314.008.02-2	1,4	15 N·cm	6,7	2,5	4,87	5,3	1,4	1,8	conical	35°	45° Chamfer	Unigrip
40.314.012.01-2	1,4	15 N·cm	4,5	1,7	2,01	2,4	2,1	2,15	conical	45°	45° Chamfer	Star 1,50
40.314.014.01-2	1,4	15 N·cm	4,45	2	2,48	-	1,97	2,16	straight	-	45° Chamfer	Hex 1,19
40.316.003.01-2	1,6	20 N·cm	8,4	2,5	6,6	-	1,8	2	straight	-	45° Chamfer	Hex 1,20
40.316.003.02-2	1,6	20 N·cm	10,2	2	7,88	8,2	2	2,2	conical	45°	45° Chamfer	Hex 1,20
40.316.004.01-2	1,6	20 N·cm	8,6	2,7	6,16	6,9	1,7	2	conical	30°	45° Chamfer	Hex 1,25
40.316.004.02-2	1,6	20 N·cm	8,8	3	6,73	6,8	1,8	2,1	conical	45°	45° Chamfer	Hex 1,25
40.316.004.03-2	1,6	20 N·cm	6,9	2,2	5,02	5,2	1,7	1,92	conical	60°	45° Chamfer	Hex 1,25
40.316.005.01-2	1,6	20 N·cm	7,5	3,6	5,33	5,85	1,65	2,15	conical	30°	45° Chamfer	Hex 1,27
40.316.005.04-2	1,6	20 N·cm	10,5	2,9	8,15	8,4	2,1	2,1	conical	45°	45° Chamfer	Hex 1,27

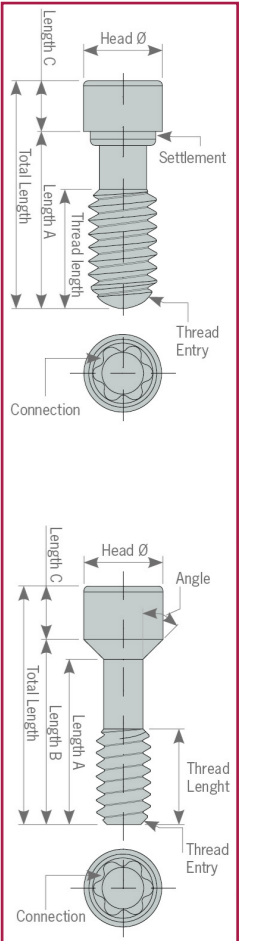

STRAIGHT SCREWS TECHNICAL SPECIFICATIONS

REFERENCE	METRIC	TORQUE	TOTAL LENGTH	THREAD LENGTH	A LENGTH	B LENGTH	C LENGTH	HEAD DIAMETER	SEAT	ANGLE	THREAD ENTRY	CONNECTION
40.316.005.05-2	1.6	20 Ncm	7,6	2,7	5,21	5,5	2,1	2,1	conical	60°	45° Chamfer	Hex 1.27
40.316.005.06-2	1.6	20 Ncm	3,6	1,8	2,2	-	1,4	2,1	straight	-	45° Chamfer	Hex 1.27
40.316.005.07-2	1.6	20 Ncm	8,8	2,85	6,73	6,9	1,9	2,15	conical	60	45° Chamfer	Hex 1.27
40.316.005.08-2	1.6	20 Ncm	9	3,9	0	6,9	2,1	2,18	conical	45°	45° Chamfer	Hex 1.27
40.316.0.07.01-2	1.6	20 Ncm	7,9	2	5,72	6,9	2,18	2,18	conical	15°	45° Chamfer	Torx T6
40.316.008.01-2	1.6	20 Ncm	7	2,7	5,15	-	1,8	2,3	straight	-	45° Chamfer	Unigrip
40.316.008.02-2	1.6	20 Ncm	7,3	2,7	5,15	5,9	1,4	2,2	conical	35°	45° Chamfer	Unigrip
40.316.012.01-2	1.6	20 Ncm	8	2,65	5,53	6	2	2,15	conical	45°	45° Chamfer	Star 1.50
40.316.014.01-2	1.6	20 Ncm	7,9	2,3	5,42	6,46	1,44	2,2	conical	20°	45° Chamfer	Hex 1.19
40.317.004.01-2	N1-72	25 Ncm	7,6	2,8	5,6	5,76	1,84	2,3	conical	70°	45° Chamfer	Hex 1.27
40.317.004.02-2	N1-72	25 Ncm	7,52	2,2	5,12	5,773	1,75	2,1	conical	30°	45° Chamfer	Hex 1.25
40.317.005.01-2	N1-72	25 Ncm	7,6	2,5	5,19	5,42	2,18	2,2	conical	60°	45° Chamfer	Hex 1.27
40.317.005.02-2	N1-72	25 Ncm	7,2	2,4	4,73	5,25	1,95	2,4	conical	45°	45° Chamfer	Hex 1.27
40.318.003.01-2	1.8	25 Ncm	6,8	3,3	5,2	-	1,6	2,3	straight	-	45° Chamfer	Hex 1.20
40.318.003.02-2	1.8	25 Ncm	8	3,6	6	-	2	2,1	straight	-	45° Chamfer	Hex 1.20
40.318.004.01-2	1.8	25 Ncm	7,2	4,47	2,3	6,2	1	2,4	conical	30°	45° Chamfer	Hex 1.25
40.318.004.03-2	1.8	25 Ncm	7,65	3,3	5,17	5,75	1,9	2,4	conical	35°	45° Chamfer	Hex 1.25
40.318.005.01-2	1.8	25 Ncm	4,5	2,3	2,8	2,9	1,6	2,35	conical	70°	45° Chamfer	Hex 1.27
40.318.005.02-2	1.8	25 Ncm	7,6	3,8	5,8	6,05	1,55	2,35	conical	50°	45° Chamfer	Hex 1.27
40.318.006.01-2	1.8	25 Ncm	6	3,18	3,5	3,85	2,15	2,4	conical	45°	45° Chamfer	Hex 1.50
40.318.007.01-2	1.8	25 Ncm	9,1	4,25	7,22	7,45	1,65	2,18	conical	60°	45° Chamfer	Torx T6
40.318.008.01-2	1.8	25 Ncm	8,3	2,5	6,5	-	1,8	2,45	straight	-	45° Chamfer	Unigrip

STRAIGHT SCREWS TECHNICAL SPECIFICATIONS

REFERENCE	METRIC	TORQUE	TOTAL LENGTH	THREAD LENGTH	A LENGTH	B LENGTH	C LENGTH	HEAD DIAMETER	SEAT	ANGLE	THREAD ENTRY	CONNECTION
40.318.012.01-2	1.8	25 Ncm	7,25	2,4	4,93	5,25	2	2,15	conical	45°	45° Chamfer	Sq. 1.50
40.318.012.02-2	1.8	25 Ncm	8	2,6	5,68	6	2	2,15	conical	45°	45° Chamfer	Sq. 1.50
40.318.013.01-2	1.8	25 Ncm	8	2,5	6,01	6,7	1,3	2,2	conical	30°	45° Chamfer	Hex 1.00
40.320.002.03-2	2	30 Ncm	10,2	3,15	8,4	-	1,8	2,45	straight	-	45° Chamfer	Sq. 1.30
40.320.003.01-2	2	30 Ncm	4,7	2,7	3,33	-	1,37	2,35	straight	-	45° Chamfer	Hex 1.20
40.320.003.02-2	2	30 Ncm	7	3,25	5	-	2	2,4	straight	-	45° Chamfer	Hex 1.20
40.320.003.03-2	2	30 Ncm	7,9	3,7	5,55	6,05	1,85	2,4	conical	45°	45° Chamfer	Hex 1.20
40.320.003.04-2	2	30 Ncm	8,4	2,75	5,68	6,35	2,05	2,3	conical	45°	45° Chamfer	Hex 1.20
40.320.003.05-2	2	30 Ncm	4,8	3,3	3,65	3,9	0,9	2,45	conical	45°	45° Chamfer	Hex 1.20
40.320.005.01-2	2	30 Ncm	7,6	3,7	6	-	1,6	2,4	straight	-	45° Chamfer	Hex 1.27
40.320.005.03-2	2	30 Ncm	10,3	3,5	8,3	-	2	2,33	straight	-	45° Chamfer	Hex 1.27
40.320.005.04-2	2	30 Ncm	10,5	3,06	8,15	8,4	2,1	2,5	conical	45°	45° Chamfer	Hex 1.27
40.320.007.01-2	2	30 Ncm	6,7	2,25	3,59	5,7	1	2,58	conical	15°	45° Chamfer	Torx T6
40.320.007.02-2	2	30 Ncm	7,4	3,3	6	-	1,4	2,3	straight	-	Semi-sphere	Torx T6
40.320.007.03-2	2	30 Ncm	7,6	3	6,1	6,3	1,3	2,4	conical	45°	Semi-sphere	Torx T6
40.320.007.04-2	2	30 Ncm	4,5	2,96	3,21	3,5	1	2,45	conical	45°	45° Chamfer	Torx T6
40.320.008.01-2	2	30 Ncm	7	3,25	5	-	2	2,4	straight	-	45° Chamfer	Unigrip
40.320.008.02-2	2	30 Ncm	7,3	3	5,8	6,2	1,1	2,5	conical	35°	45° Chamfer	Unigrip
40.320.008.03-2	2	30 Ncm	10	3,6	8,5	-	1,5	2,45	straight	-	45° Chamfer	Unigrip
40.325.008.01-2	2,5	30 Ncm	7	2,8	5,6	-	1,4	3,4	straight	-	45° Chamfer	Unigrip

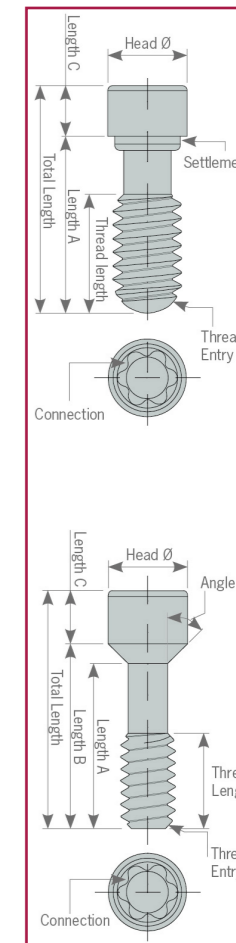

SCREWDRIVERS



STRAIGHT SCREWS

Straight screws cover all the thread metrics available on the market. We have several lengths for each metric to make the adaptation to the milled structures easier.



DYNAMIC MILLING TOOL SPECIFICATIONS

MAIN COMPATIBILITY	REFERENCE	CUTTING DIAMETER	SEAT	CUTTING LENGTH	USEFUL LENGTH (max. drilling depth)	STEM CUTTING DIAMETER	SUPPORT DIAMETER (SHANK)	TOTAL LENGTH
		$\varnothing c$	α	L_c	L_u	$\varnothing v$	$\varnothing s$	L_t
BEGO RS/RSX 3° ASTRA EVOLUTION 3.0° *Only for titanium and soft materials	33.325.472.01-2	1.4	25	0.4	4.7	0.5	3	50
	33.425.472.01-2	1.4	25	0.4	4.7	0.5	4	50
	33.625.472.01-2	1.4	25	0.4	4.7	0.5	6	50
STRAUMANN BONE LEVEL NP STRAUMANN BONE LEVEL RP MEDENTIS ICX TEMPLANT 4.1 STRAUMANN SYNOCCTA 3.5 MEDENTIS ICX NARROW	33.315.804.01-2	1.6	15	0.7	8	0.65	3	50
	33.415.804.01-2	1.6	15	0.7	8	0.65	4	50
	33.615.804.01-2	1.6	15	0.7	8	0.65	6	50
ANTHOGRYR AXIOM RG/PX XNP ANTHOGRYR AXIOM RG/PX RP ANTHOGRYR AXIOM RG/PX WP	33.320.704.01-2	1.6	20	0.7	7	0.8	3	50
	33.420.704.01-2	1.6	20	0.7	7	0.8	4	50
	33.620.704.01-2	1.6	20	0.7	7	0.8	6	50
ASTRA EVOLUTION 3.6 ANKYLOS ALPHABIO CONICAL STANDARD CON- NECTION LASAK BIONIQ OR NEODENT GM ANKYLOS BALANCE BASE	33.330.734.01-2	1.6	30	0.7	7.3	0.8	3	50
	33.430.734.01-2	1.6	30	0.7	7.3	0.8	4	50
	33.630.734.01-2	1.6	30	0.7	7.3	0.8	6	50
NOBEL BIOCARE ACTIVE NP NOBEL BIOCARE ACTIVE 3.0 LASAK BIONIQ ON	33.335.754.01-2	1.6	35	0.7	7.5	0.65	3	50
	33.435.754.01-2	1.6	35	0.7	7.5	0.65	4	50
	33.635.754.01-2	1.6	35	0.7	7.5	0.65	6	50
OSSTEM TS NP CAMLOG SCREW LINE 3.8 NP CAMLOG SCREW LINE 4.3 RP KLOCKNER VEGA NV XIVE S 3.4 BIOTECH DENTAL KONTAKT XNP BIOTECH DENTAL KONTAKT RP DIO UF NP CAMLOG SCREW-LINE 3.3	33.345.804.01-2	1.6	45	0.7	8	0.65	3	50
	33.445.804.01-2	1.6	45	0.7	8	0.65	4	50
	33.645.804.01-2	1.6	45	0.7	8	0.65	6	50
MIS C1 NP MIS M4 NP CONOLOG 3.8 CONOLOG 4.3 ASTRA YELLOW ALPHABIO CONICAL HEX CONNECTION	33.360.754.01-2	1.6	60	0.7	7.5	0.65	3	50
	33.460.754.01-2	1.6	60	0.7	7.5	0.65	4	50
	33.660.754.01-2	1.6	60	0.7	7.5	0.65	6	50
BIOMET 3i CERTAIN NP ASTRA AQUA	33.390.754.01-2	1.6	90	0.7	7.5	0.65	3	50
	33.490.754.01-2	1.6	90	0.7	7.5	0.65	4	50
	33.690.754.01-2	1.6	90	0.7	7.5	0.65	6	50
ASTRA EVOLUTION 4.2	33.350.775.01-2	1.7	50	0.7	7.7	0.8	3	50
	33.450.775.01-2	1.7	50	0.7	7.7	0.8	4	50
	33.650.775.01-2	1.7	50	0.7	7.7	0.8	6	50
BIOMET 3i CERTAIN RP NOBEL BIOCARE BRANEMARK NP NOBEL BIOCARE REPLACE NP MEGAGEN ANYRIDGE RP BIOMET 3i CERTAIN WP	33.390.805.01-2	1.7	90	0.7	8	0.65	3	50
	33.490.805.01-2	1.7	90	0.7	8	0.65	4	50
	33.690.805.01-2	1.7	90	0.7	8	0.65	6	50

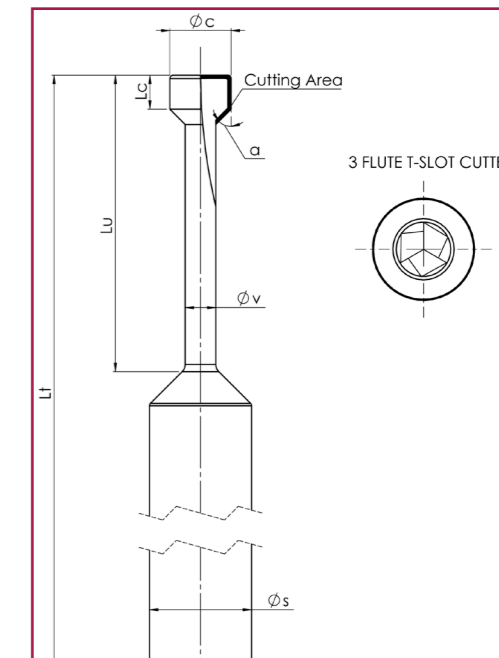

DYNAMIC MILLING TOOL SPECIFICATIONS

MAIN COMPATIBILITY	REFERENCE	CUTTING DIAMETER	SEAT	CUTTING LENGTH	USEFUL LENGTH (max. drilling depth)	STEM CUTTING DIAMETER	SUPPORT DIAMETER (SHANK)	TOTAL LENGTH
		Øc	α	Lc	Lu	Øv	Øs	Lt
BEGO S/RI 3.25-3.75 BEGO S/RI 4.1 BEGO S/RI 4.5 BEGO S/RI 5.50 STRAUMANN SCREW-RETAINED NC/RC BEGO MULTI-PLUS	33.335.676.01-2	1.8	35	1	6.7	0.9	3	50
	33.435.676.01-2	1.8	35	1	6.7	0.9	4	50
	33.635.676.01-2	1.8	35	1	6.7	0.9	6	50
KLOCKNER ESSENTIAL CONE 4.5 DIRECTO IMPLANTE KLOCKNER ESSENTIAL CONE 4.5 OCTACONE 12° KLOCKNER ESSENTIAL CONE 4.5 OCTACONE 25° KLOCKNER VEGA RV XIVE S 3.8 XIVE S 4.5 BIOHORIZONS 3.0 STRAUMANN SYNOCTA 6.5 STRAUMANN BLX RB STRAUMANN BLX WB STRAUMANN TLX NT STRAUMANN TLX RT STRAUMANN TLX WT	33.345.856.01-2	1.8	45	1	8.5	0.9	3	50
	33.445.856.01-2	1.8	45	1	8.5	0.9	4	50
	33.645.856.01-2	1.8	45	1	8.5	0.9	6	50
	33.360.756.01-2	1.8	60	1	7.5	0.9	3	50
MIS C1 RP PALTOP UNIVERSAL MULTI UNIT MIS C1 WP S&M PREMIUM KHONO 3.3 S&M PREMIUM KHONO 3.8 S&M OUTLINK 3.3 S&M OUTLINK 4.1 S&M PREMIUM KHONO 4.25 BREDENT SKY NP BREDENT SKY RP ADIN TOUAREG/CLOSEFIT NP ADIN TOUAREG/CLOSEFIT UNP CAMLOG CONELO 3.3 GLOBAL D (TEKKA) EASY IMPLANT MINI	33.460.756.01-2	1.8	60	1	7.5	0.9	4	50
	33.660.756.01-2	1.8	60	1	7.5	0.9	6	50
	33.370.716.01-2	1.8	70	1	7.1	0.9	3	50
	33.470.716.01-2	1.8	70	1	7.1	0.9	4	50
ZIMMER SCREW-VENT 3.5 ZIMMER SCREW-VENT 4.5 ASTRA EVOLUTION UNIT ABUTMENT ZIMMER TYPE 5.7	33.670.716.01-2	1.8	70	1	7.1	0.9	6	50
	33.390.716.01-2	1.8	90	1	7.1	0.9	3	50
	33.490.716.01-2	1.8	90	1	7.1	0.9	4	50
NOBEL BIO CARE BRANEMARK RP NOBEL BIO CARE MULTI-UNIT RP BIOMET 3i OSSEOTITE NP BTI EXTERNAL CONNECTION NP BTI INTERNAL CONNECTION NP MIS MULTI-UNIT ST KEYSTONE PRIMA NP KEYSTONE PRIMA RP KEYSTONE PRIMA WP NEOSS PROACTIVE 3.4 NEOSS PROACTIVE 4.1 BIOMET 3i OSSEOTITE WP BTI EXTERNAL CONNECTION WP BTI MULTI-IM UNIVERSAL RP ANTHOGYRD MULTI-UNIT 4.8 BEGO MINI BTI INTERNAL WP LASAK MULTI-UNIT QN/OR SIC SICACE 3.3 SIC SICACE 4.2	33.690.716.01-2	1.8	90	1	7.1	0.9	6	50

DYNAMIC MILLING TOOL SPECIFICATIONS

MAIN COMPATIBILITY	REFERENCE	CUTTING DIAMETER	SEAT	CUTTING LENGTH	USEFUL LENGTH (max. drilling depth)	STEM CUTTING DIAMETER	SUPPORT DIAMETER (SHANK)	TOTAL LENGTH
		Øc	α	Lc	Lu	Øv	Øs	Lt
STRAUMANN INTERNAL OCTAGON RP STRAUMANN INTERNAL OCTAGON 6.5	33.315.708.01-2	2	15	1	7	1	3	50
	33.415.708.01-2	2	15	1	7	1	4	50
	33.615.708.01-2	2	15	1	7	1	6	50
STRAUMANN SYNOCTA RP	33.330.708.01-2	2	30	1	7	1	3	50
	33.430.708.01-2	2	30	1	7	1	4	50
	33.630.708.01-2	2	30	1	7	1	6	50
NOBEL BIO CARE ACTIVE RP NOBEL BIO CARE ACTIVE WP	33.335.758.01-2	2	35	1	7.5	1	3	50
	33.435.758.01-2	2	35	1	7.5	1	4	50
	33.635.758.01-2	2	35	1	7.5	1	6	50
OSSTEM TS RP CAMLOG SCREW-LINE 5.0 CAMLOG SCREW-LINE 6.0	33.345.808.01-2	2	45	1	8	1	3	50
	33.445.808.01-2	2	45	1	8	1	4	50
	33.645.808.01-2	2	45	1	8	1	6	50
NOBEL BIO CARE REPLACE RP ASTRA LILAC ASTRA EVOLUTION 4.8 NOBEL BIO CARE BRANEMARK WP ASTRA EVOLUTION 5.4 NOBEL BIO CARE REPLACE 6.0	33.390.958.01-2	2	90	1	9.5	1	3	50
	33.490.958.01-2	2	90	1	9.5	1	4	50
	33.690.958.01-2	2	90	1	9.5	1	6	50



SCREWDRIVER ADAPTOR

Screwdriver for the Dynamic Scanbody System

Ref. 43.621.410.01-2
Screwdriver with manual handle
Standard length: 21 mm



Ref. 43.624.410.01-2
Contra-angle
Length: 24 mm



Ref. 43.621.415.01-2
Tiny Screwdriver with manual handle
Length: 21 mm

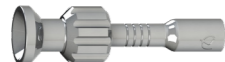

Ref. 43.620.411.01-2
Multi-Unit
Contra-angle
Length: 20 mm



COMPLEMENTS

Manual handle

Made of stainless steel.
They are used to connect screwdriver bits with the contra-angle connection



Large manual handle for laboratory

Ref. 49.601.000.03-2
Ideal to manipulate models in the laboratory
Length: 55.65 mm



Manual handle for clinic

Ref. 49.601.000.01-2
Clinic handle: used to position the prosthesis in the mouth prior to torque control in the clinic.
Length: 15.65 mm



Universal manual torque wrench prosthetic

Ref. 11.990.990.07-2
Torque wrench
4 mm square connection.
Torque 10-35N.c



Dynamic Screw Transfer

Ref. 49.413.000.01-2

Manual torque wrench adapter prosthetic

Piece to connect the screwdriver with contra-angle connection to the torque wrench.



Universal Manual torque wrench adapter
Ref. 49.604.000.05-2
4 mm Square connection



Straumann Manual torque wrench adapter
Ref. 49.604.000.07-2
Straumann connection



Nobel Biocare Manual torque wrench adapter
Ref. 49.604.000.08-2



MIS Manual torque wrench adapter
Ref. 49.604.000.09-2

DYNAMIC SCREWDRIVERS

Screwdriver with hexalobular head, exclusively to the 3.0 Dynamic Abutment System.
Lengths: 18, 24, 32 mm

Hexalobular 1,70 mm. Length: 18 mm



Ref. 43.618.201.01-2

Hexalobular 1,70 mm. Length: 24 mm



Ref. 43.624.201.01-2

Hexalobular 1,70 mm Length: 32 mm



Ref. 43.632.201.01-2

DAS MU SYSTEM COMPONENTS



Ratchet
49.409.000.01-2



Screwdriver
43.321.316.01-2
43.322.316.01-2



Healing Cap Regular
40.320.003.88-2



Healing Cap Wide
40.320.003.89-2



Impression coping
29.301.000.10-2 (Engaging)
29.301.000.11-2 (Non-engaging)



Analog
22.612.209.01-2



Titanium Abutment
35.312.209.21-2



Digital Analog
34.312.209.01-2



MU ScAnalog
23.412.209.01-2



MU Scanbody 4,5 mm
53.412.209.01-2



MU Scanbody 8 mm
53.422.209.02-2 (Non-engaging)



MU Dynamic Scanbody
52.408.137.01-2



Dynamic Scanbody Adaptor
50.312.209.01-2



Screwdriver Adaptor
43.621.410.01-2
43.624.410.01-2



Reference Scanbody
54.322.209.31-2



Peek Pins
49.414.000.01-2 (6 mm)
49.415.000.01-2 (9 mm)
49.416.000.01-2 (13 mm)



CAPS
49.418.000.01-2 (3,8 mm)
49.419.000.01-2 (6 mm)
49.420.000.01-2 (8 mm)



MU Dynamic TiBase
31.312.209.01-2 (Engaging)



31.322.209.01-2 (Non-engaging)



MU Dynamic 3TiBase
31.322.209.21-2 (Non-engaging)



Dynamic Screw
41.320.040.01-2



Provisional (temporary) Dynamic Screw
41.320.050.02-2



Straight Screw
40.320.003.06-2



Dynamic Screwdriver
43.618.201.01-2 (18 mm)
43.624.201.01-2 (24 mm)
43.632.201.01-2 (32 mm)



Screwdriver Hex.1,2
43.601.103.02-2



MU DMTone
33.390.716.01-2 Shank Ø3
33.490.716.01-2 Shank Ø4
33.690.716.01-2 Shank Ø6

TALLADIUM GUARANTEE

TERMS AND CONDITIONS

These guarantee terms and conditions ("T&C") cover the entire range of Talladium products ("Products"), manufactured by TALLADIUM ESPAÑA S.L. and distributed by Geoda Medical S.L. or official dealers. The guarantee described in these T&C is exclusively in benefit of the clinician ("Clinician") and of the dental technician ("Technician") and not for the benefit of third parties or institutions, including patients.

GUARANTEE PERIOD

TALLADIUM ESPAÑA S.L. offers a lifelong guarantee for its entire range of products starting from the date of issue of the invoice.

GUARANTEE SCOPE

Subject to the limitations and exceptions described in these T&C, TALLADIUM ESPAÑA S.L. will offer the following benefits:

QUALITY: If there are defects in the materials or in the manufacturing of the Product, TALLADIUM ESPAÑA S.L. will replace the Product with no additional cost.

SAFETY: If, having complied with all the product indications, the prosthesis should have to be made again, due to a fault in the Dynamic Abutment or Dynamic Titanium Base system,

TALLADIUM ESPAÑA S.L. will replace the abutments and screws necessary to remake the prosthesis, as well as the costs derived from its manufacturing.

In case of having used our products and having complied with all the product indications, the implants suffer any damage, TALLADIUM ESPAÑA S.L. will pay the cost of the implants. This coverage will only be valid during the first 6 months after the collocation of the prosthesis which includes our products.

CLAIM REQUIREMENTS AND PROCEDURE

To receive the benefits indicated in these T&C, the treating Clinician must satisfy the following requirements:

a) The claim must be notified to TALLADIUM ESPAÑA S.L. within (30) days since the date the claimed defect was detected.

b) This requires that the Clinician or Technician must contact the customer service department by telephone or by e-mail to make the claim.

c) A claim form will be completed, which, together with a document or report which justifies the faulty Product and the faulty Product itself, will be sent by the customer to TALLADIUM ESPAÑA S.L. offices, within the previously indicated period.

d) Clinicians or Technicians presenting a claim in agreement with these T&C must be up to date in any payments owing to TALLADIUM ESPAÑA S.L. or to any of its subsidiaries, at the time when the claim form is presented.

e) All the use procedures of our Products must be carried out in agreement with the instructions of TALLADIUM ESPAÑA S.L. as well as in accordance with commonly accepted dentistry practices.

f) The expenses derived from this procedure will be assumed by the customer. The return shipping costs will be assumed by TALLADIUM ESPAÑA S.L. in all those cases covered by these T&C. Regardless of the guarantee rights, claims should be notified as soon as possible in order to comply with regulatory requirements.

GENERAL LIMITATIONS OF THIS GUARANTEE

With the exception of the guarantee described in these T&C, neither TALLADIUM ESPAÑA S.L. nor its representatives, nor third parties manufacturing or distributing the Products, represent or offer a guarantee, agreement or any other express or implicit, oral or written, commitment, with respect to the Products (without limitation), including guarantees involved in the marketing, durability or suitability for individual uses or purposes. In addition and within the maximum extent permitted by the relative law, TALLADIUM ESPAÑA S.L. rejects (on its own behalf, and on behalf of its representatives and third parties that manufacture or distribute Products) any responsibility with respect to any direct or indirect damage caused, which may result from or be a consequence of the design, composition of the dental prosthesis into which the Products are integrated.

GUARANTEE EXCLUSIONS

TALLADIUM ESPAÑA S.L. limits this guarantee to:

- Transformed abutments that form part of the dental prosthesis. But not the screws used to anchor them.

- Clinical screws that have been in the mouth for more than 2 years.

- Those products that are not used with the accessories and parts marketed by Talladium España

AMENDMENT OR SUSPENSION OF THE GUARANTEE

TALLADIUM ESPAÑA S.L. reserves the right to amend or withdraw these T&C at any time and without prior notification. Any modification or suspension shall not affect products already placed in patients.

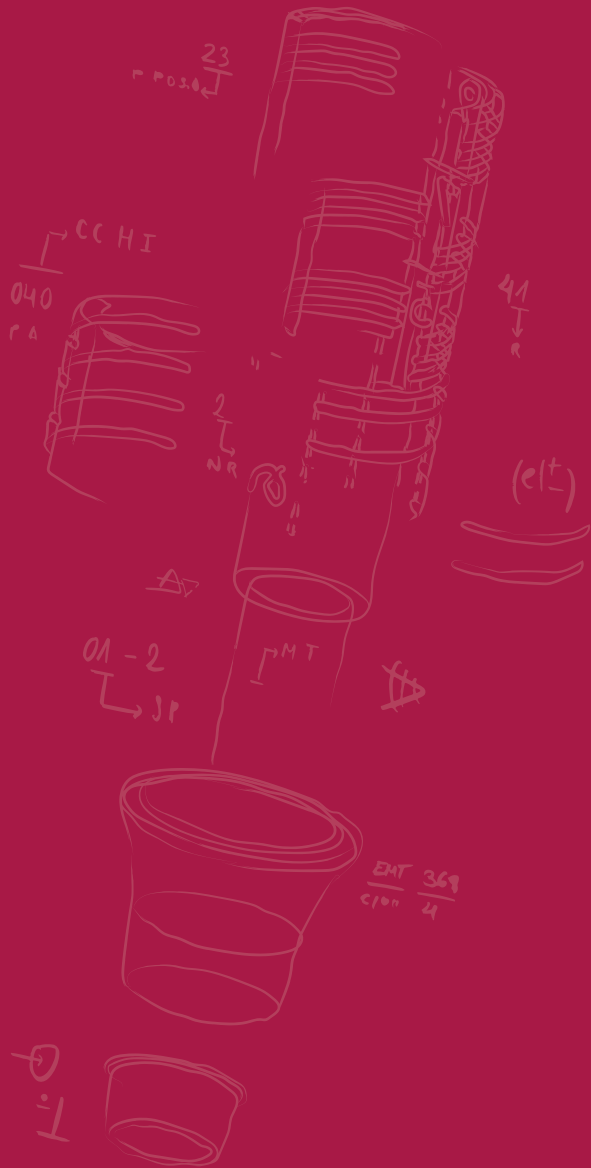

DYNAMIC ABUTMENT SOLUTIONS

Virginia Woolf, 17
25005 · Lleida (Spain)

INTERNATIONAL +34 873 450 709
das@dynamicabutment.com

SPAIN +34 973 289 580
spain@dynamicabutment.com



www.dynamicabutment.com

