

45°

DYNAMIC ABUTMENT SOLUTIONS

# DIGITAL solutions



**DYNAMIC  
ABUTMENT  
SOLUTIONS**



## DYNAMIC ABUTMENT® SOLUTIONS

VIRGINIA WOOLF, 17 · 25005 · LLEIDA (SPAIN)  
INTERNATIONAL +34 973 289 580  
das@dynamicabutment.com

SPAIN +34 973 289 580  
spain@dynamicabutment.com

Dynamic Abutment® Solutions is the trademark of the manufacturer Talladium España S.L.

The information included in this catalogue is exclusively addressed to professionals in dental sector.

All commercial trademarks mentioned herein are fully registered by their respective companies, and the images that appear are just to provide an orientation. Talladium reserves the right to modify this document without previous notice. Talladium is not responsible for the inadequate execution of these products if the warning indications corresponding to every reference are not contemplated.

Ask about the products available with CE legislation. Some of the products are not authorized for sale and distribution or do not have a sales license in some countries according to other legislations. Please ask for information: das@dynamicabutment.com



Visit our Online Store to find all our products and compatibilities:  
[www.dynamicabutmentsstore.com](http://www.dynamicabutmentsstore.com)

## DYNAMIC ABUTMENT® SOLUTIONS DYNAMIC DASSYSTEM

5	<i>DYNAMIC ABUTMENT® SOLUTIONS</i>
6	<i>DYNAMIC SYSTEM FOR MILLING STRUCTURES</i>
8	<i>DYNAMIC SYSTEM</i>
10	<i>CADCAM WORKFLOW - DYNAMIC SYSTEM</i>
12	<i>DYNAMIC μSCANBODY/ ADAPTOR</i>
14	<i>LAB SCANBODY</i>
15	<i>SCANALOG</i>
16	<i>REFERENCE SCANBODY</i>
18	<i>DYNAMIC TIBASE®/DYNAMIC 3TIBASE®</i>
20	<i>DYNAMIC TIBASE® GINGIVAL OPTIONS</i>
22	<i>DYNAMIC MILLING TOOL - DMTONE®</i>
24	<i>DIGITAL ANALOG</i>
26	<i>TIBASE® VALIDATION PATTERN</i>
27	<i>DIGITAL ANALOG VALIDATION PATTERN</i>
28	<i>DAS LIBRARIES</i>
30	<i>IMPLANT PLANNING</i>
31	<i>CAD-CAM</i>
35	<i>DYNAMIC SYSTEM - LIST OF COMPATIBILITES</i>
36	<i>DYNAMIC SYSTEM COMPATIBILITES</i>

## DYNAMIC ABUTMENT® SOLUTIONS MULTI-UNIT DASSYSTEM

64	<i>MULTI-UNIT DAS SYSTEM</i>
66	<i>CAD-CAM WORKFLOW - MULTI-UNIT DAS SYSTEM</i>
68	<i>MULTI-UNIT</i>
70	<i>MULTI-UNIT SCANBODY</i>
70	<i>MULTI-UNIT SCANALOG</i>
70	<i>DYNAMIC μSCANBODY</i>
71	<i>DIGITAL ANALOG - ANALOG</i>
72	<i>DYNAMIC® TIBASE</i>
73	<i>DIRECT TO IMPLANT (ONE PIECE)</i>
74	<i>MILLING OPTIONS</i>
77	<i>MULTI-UNIT - LIST OF COMPATIBILITES</i>
78	<i>DAS MULTI-UNIT COMPATIBILITES</i>
94	<i>DAS MULTI-UNIT LIBRARIES</i>
95	<i>MU DAS SYSTEM - COMPONENTS</i>
96	<i>TALLADIUM GUARANTEE</i>



## DYNAMIC ABUTMENT® SOLUTIONS

DYNAMIC ABUTMENT SOLUTIONS is the brand that encompasses all products designed by the R&D center of Talladium España to provide solutions that solve problems of incorrect positioning of implants and improves the aesthetics and function of the prosthesis.

Over 20 years ago with the launch of Dynamic Abutment, which has been successfully used in more than 1.000.000 cases in many countries, Dynamic Abutment Solutions has become a clear leader in the market for dental angled abutments.

Dynamic Abutment® Solutions presents new developments with our own technology applied to the digital design field. We have developed a wide portfolio of products as part of a complete system for Cad-cam. This portfolio includes all digital resources to resolve the complexity of angulation in Cad-cam



# DYNAMIC SYSTEM for MILLING STRUCTURES

The Screwdriver set of 3.0 Dynamic Abutment® System is used in those cases in which rectification of the entry of the screw due to an unfavorable position of the implants is necessary, improving the functionality and aesthetics of the milled prosthesis.

More than 1.000.000  
cases resolved with  
**DYNAMIC SYSTEM**

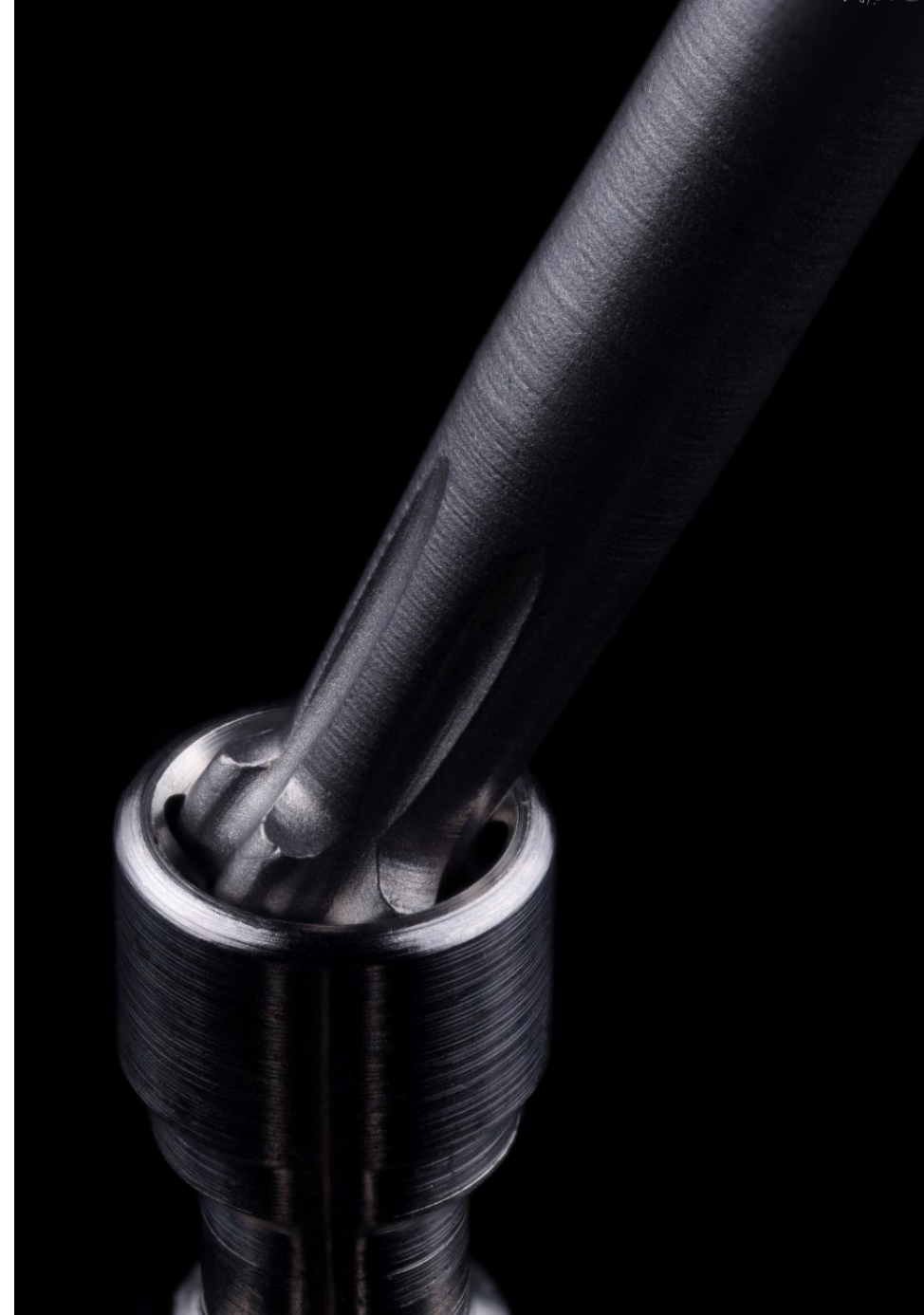

PATENT NUMBER  
Dynamic Screwdriver  
EP 3 260 079

## Dynamic Screwdriver

Screwdriver with hexalobular head, exclusively to the 3.0 Dynamic Abutment® system.

Lengths: 18, 24, 32mm.



## Dynamic Screw

PATENT NUMBER  
Dynamic Screw  
US 2020/15942

Our screwdriver has a contra-angle connection to make it easier to use with a dynamometer or manual ratchet, with the corresponding adaptors or handles.



## High Dynamic Screw

Dynamic screws cover the majority of the thread metrics available on the market. They are used with the Dynamic TiBase® or milled structures with an angled screw channel. There are several lengths for each metric to ease adaptation to the structures. All of them are made of Titanium grade V.

All screws are perfectly identified with their batch and reference numbers, which allow each and every screw to be traced and recorded in the patient's card and in the clinical or laboratory records. Only the 3.0 dynamic screwdriver may be used to install them.

DYNAMIC ABUTMENT\* SOLUTIONS

# DYNAMIC DASSYSTEM

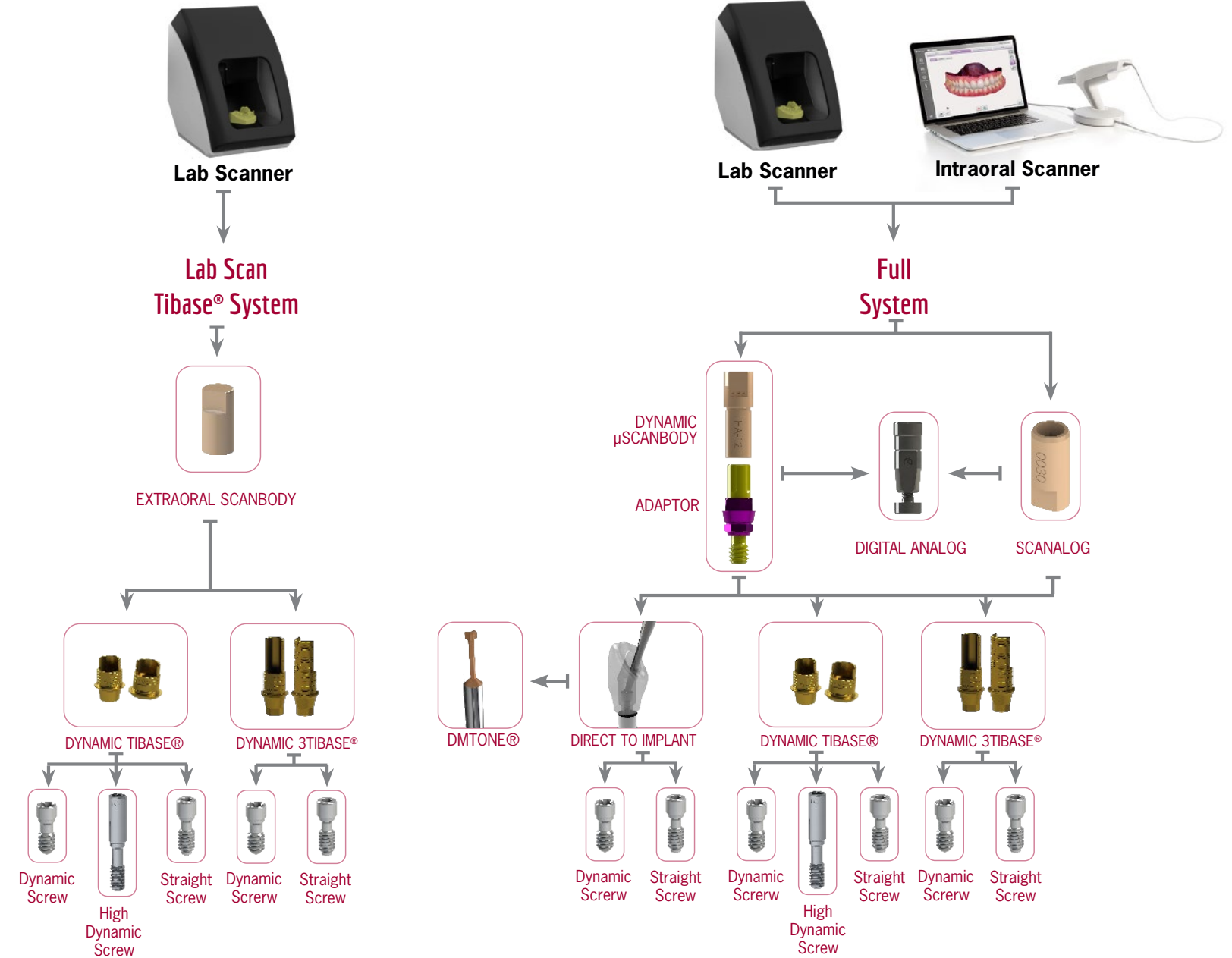

# DAS PRODUCTS

## CAD-CAM WORKFLOW

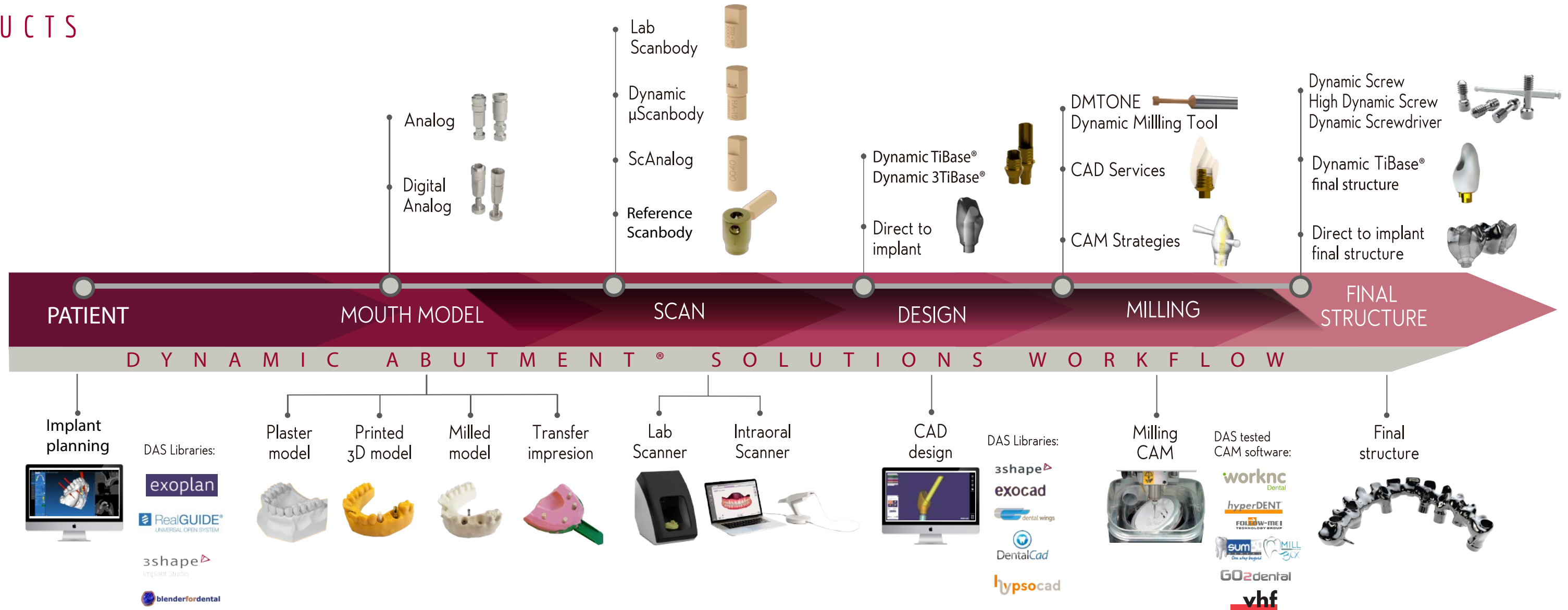

# DYNAMIC μSCANBODY

The scanbody detects the position and orientation of the respective dental implant or analog in CAD-CAM scanning procedures.

**Hole free scanbody and not screwed**  
There are no holes in the upper section which means the Z axis is free to improve scanbody scanning.

The angulation of the chimney always goes on the opposite side of the scanbody lateral cut.

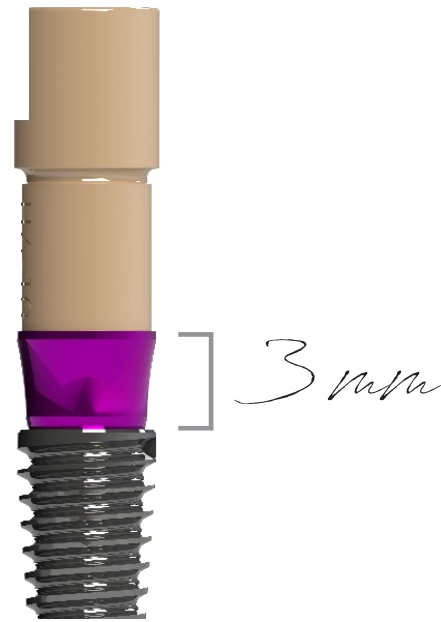

**3 lengths**  
(8mm, 10mm and 12mm) for the most complex scanbody reading cases.

# ADAPTOR

Fastened to an adaptor using a magnet

Connecting element between the scanbody and the implant.  
Marked with different colors according to the compatibility.

Special screwdriver for the adaptor.

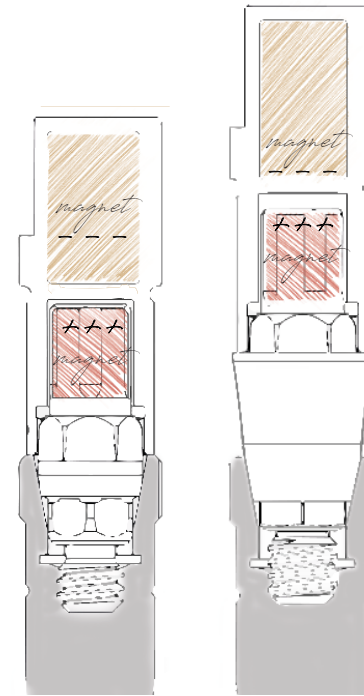

**OPTION 1**  
library  
DAS\_I\_XXXX

**OPTION 2**  
library\*  
DAS\_IG\_XXXX

\*Use IG Library code with the 3mm adaptor

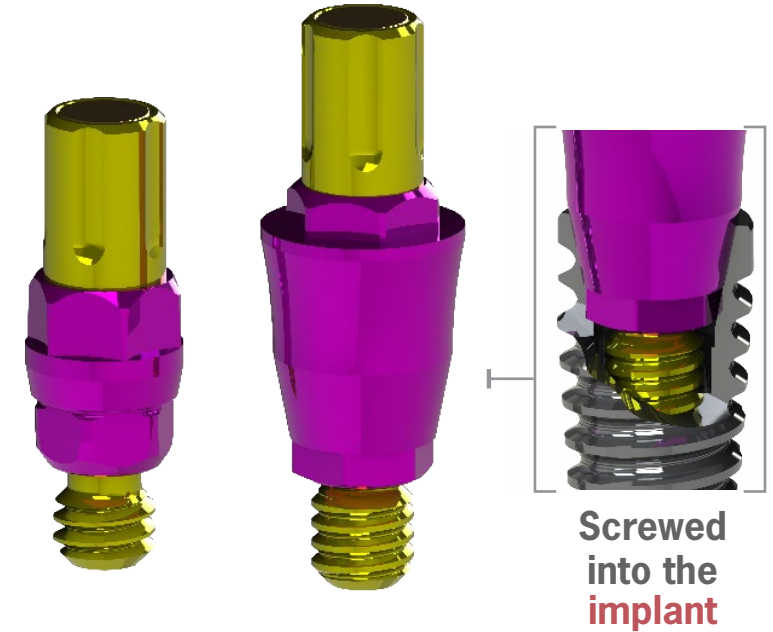

**Screwed into the implant**



# LAB SCANBODY

Only for Dynamic TiBase® and Lab Scanner

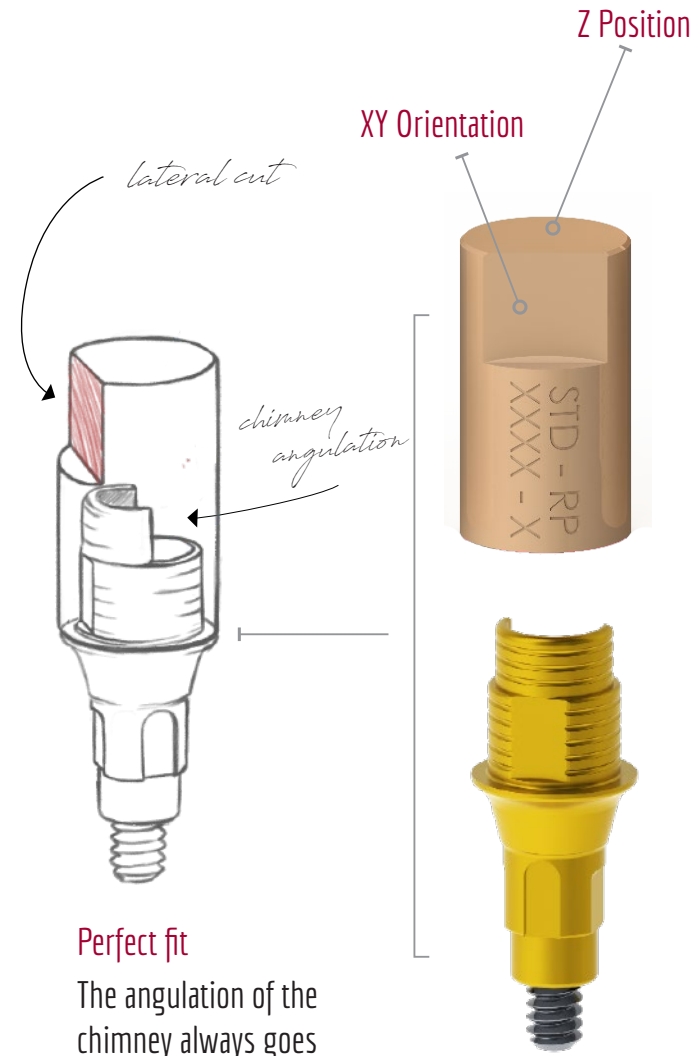
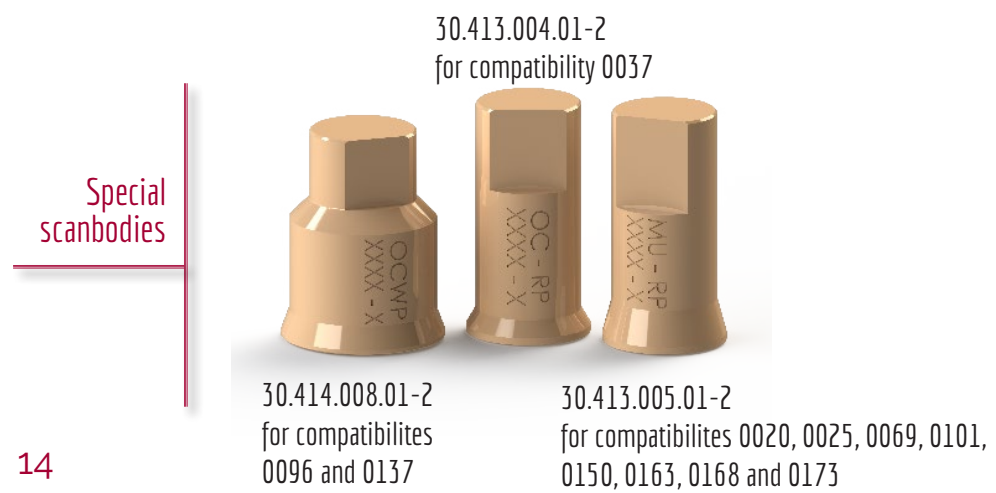
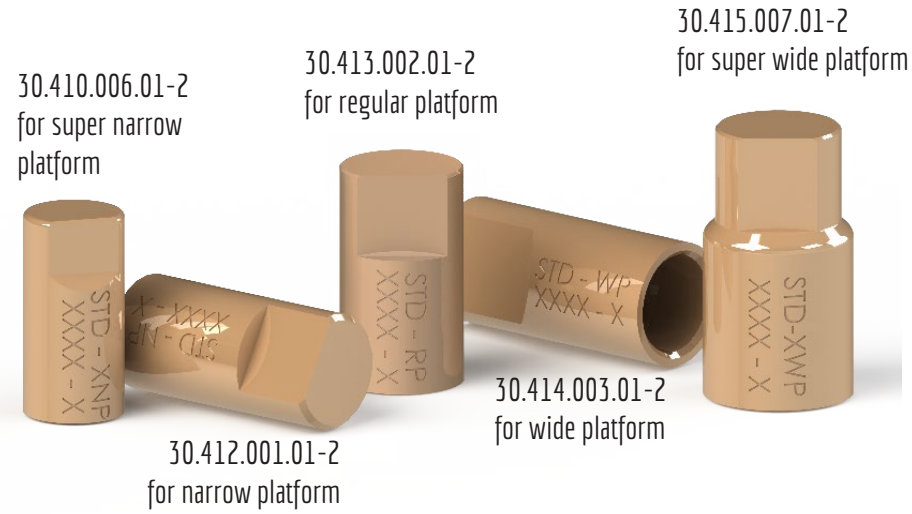

**Perfect fit**  
The angulation of the chimney always goes on the opposite side of the scanbody lateral cut.

# ScAnalog

Scan directly on the impression tray



# Scanning

Scanning process of the silicon model with the ScAnalog placed.

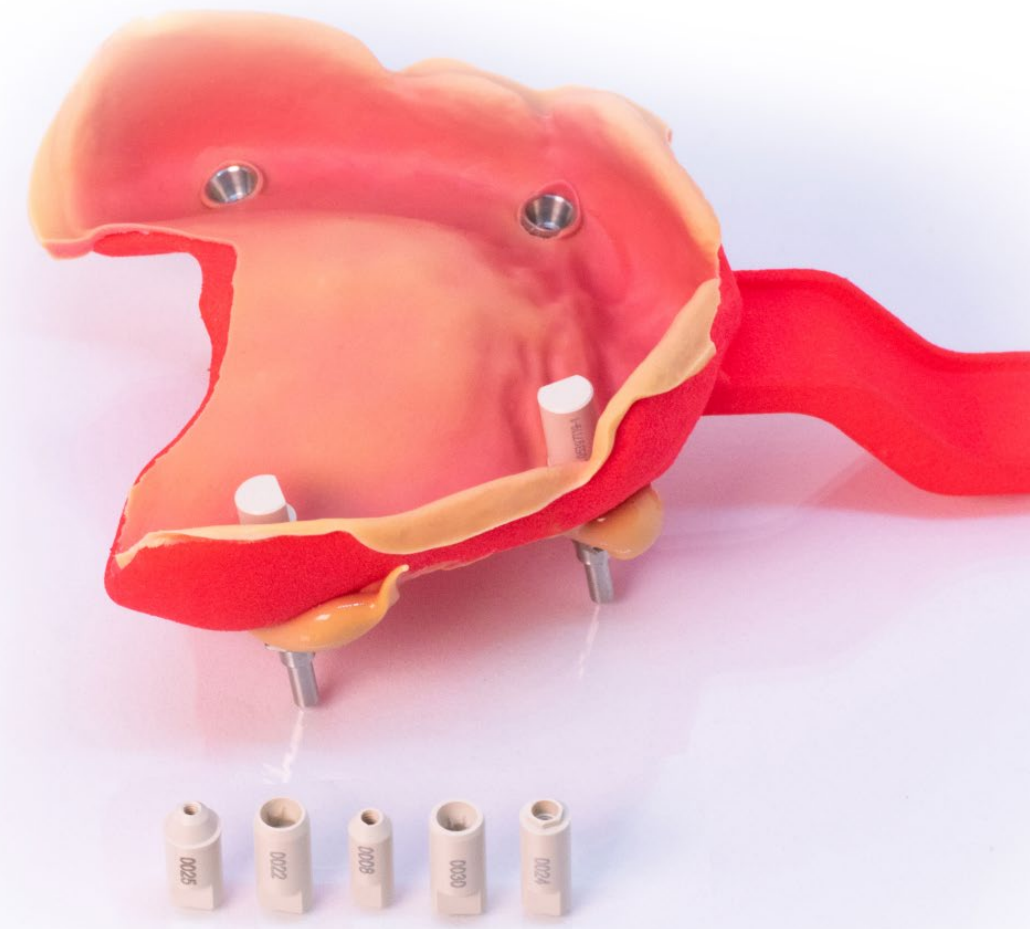



## REFERENCE SCANBODY

Peek pins are used to be fixed to the reference scanbody to avoid losing the reference between implants during scanning process in edentulous cases.



### SCANBODY

Titanium scanbody compatible for different connections.

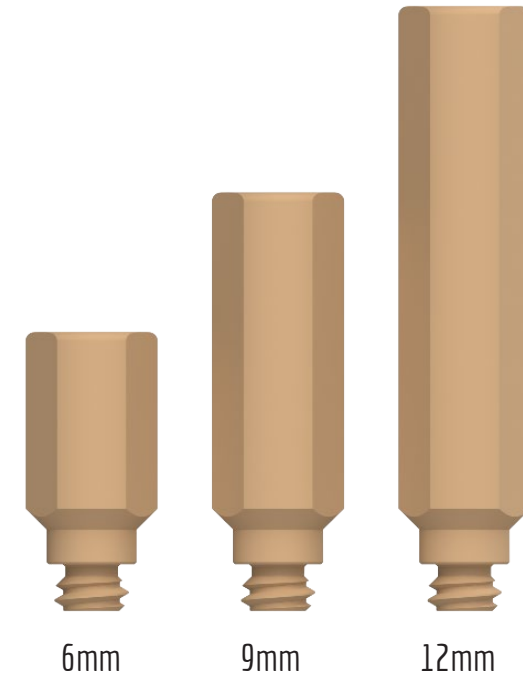

### PEEK PINS

3 different heights according to the needs of the case.



## DYNAMIC TIBASE®\*

Dynamic TiBases® are a technological contribution for the digital treatment of the angled systems development using CAD-CAM: the Dynamic System includes the Dynamic TiBase®, the dynamic screw-screwdriver set, scanbodies and digital libraries available for the main CAD softwares on the market: Exocad, 3Shape, Dentalwings and Dental Cad.

PATENT NUMBER  
Dynamic TiBase®  
US 10.130.447

TO CORRECT  
ANGULATION

up to  
45°



Dynamic screw

Straight screw

\*Maximum angulation available for the first TiBase gingival height. Maximum angulations for the rest of gingival heights under development

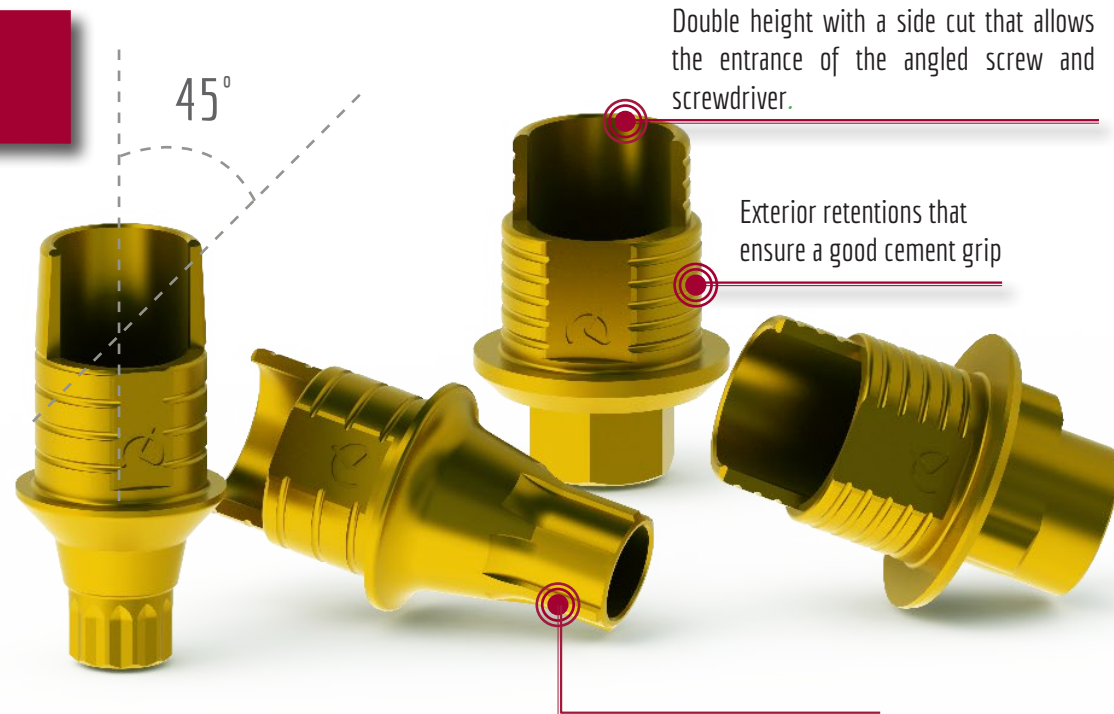

Double height with a side cut that allows the entrance of the angled screw and screwdriver.

Exterior retentions that ensure a good cement grip

Our grade V titanium bases are **gold anodized** to improve the work's aesthetic.

Precision machined up to +/- 5 microns

## DYNAMIC 3TIBASE®

The Dynamic 3TiBase® offers the possibility of working with different cement heights: 5, 7 or 9mm. It is specially designed for cases that require higher height. In this way, a greater support surface is achieved, the structure is stronger and more resistant so structure breaks by height decompensation between the TiBase and the structure are avoided.

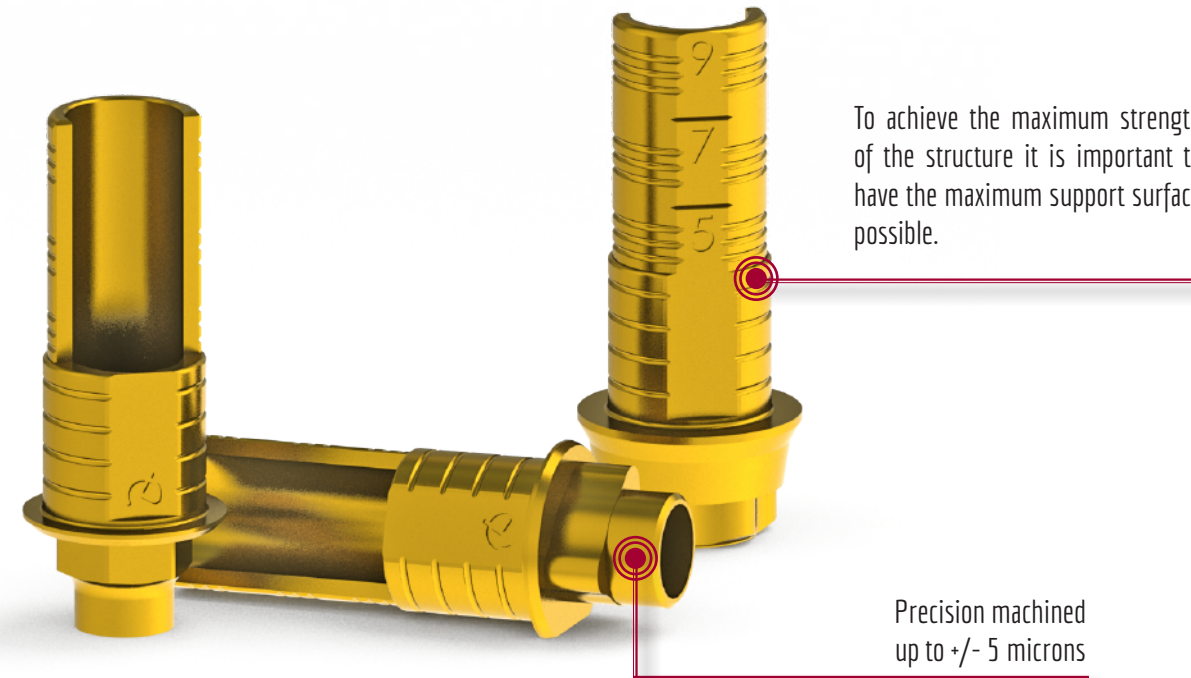

To achieve the maximum strength of the structure it is important to have the maximum support surface possible.

Precision machined up to +/- 5 microns



Scan with the Dynamic μScanbody and cement the final piece onto the 3TiBase.

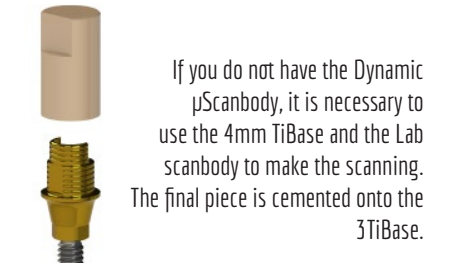

If you do not have the Dynamic μScanbody, it is necessary to use the 4mm TiBase and the Lab scanbody to make the scanning. The final piece is cemented onto the 3TiBase.

# DYNAMIC TIBASE®

## Gingival options



\*Example with TiBase® compatible with Zimmer Screw-Vent Ø3,5 (Code 0040)



- Keep the angulation
- Best aesthetic angled channel Ø 2mm
- Angled channel reduction of 32%
- Increases the volume of the structure
- Captive Screw

(Put the screw on the TiBase® before cementing)

# DYNAMIC MILLING TOOL

Each tool is compatible depending on screw seating, metric and length



Shank  
Ø3, Ø4, Ø6

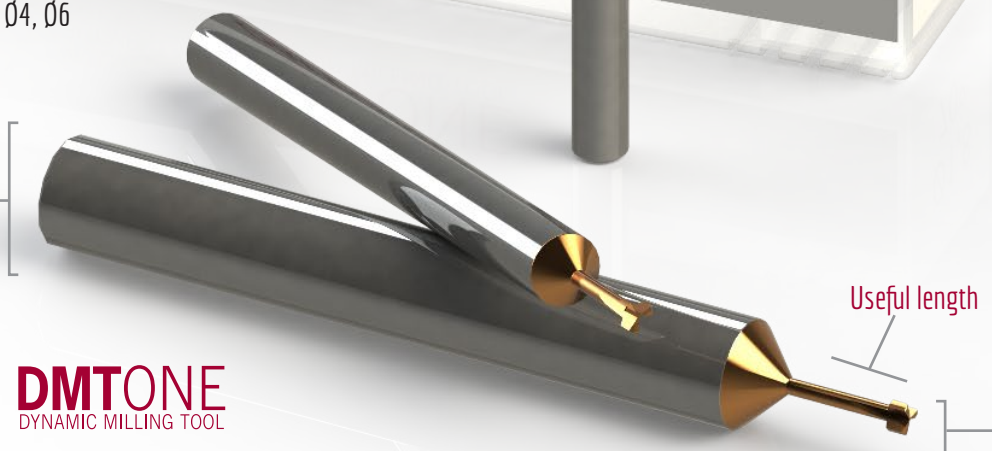

**DMTONE**  
DYNAMIC MILLING TOOL

# DIRECT TO IMPLANT (one piece) and ANGULATED

Precision milling tool. In the screwed angled structure direct to implant, it is used to mill the screw seating and to increase the internal diameter of the straight channel.

There are 3 cutting wing-tips with 3 different cutting area each, to mill the screw seating and to increase the internal diameter of the straight channel.

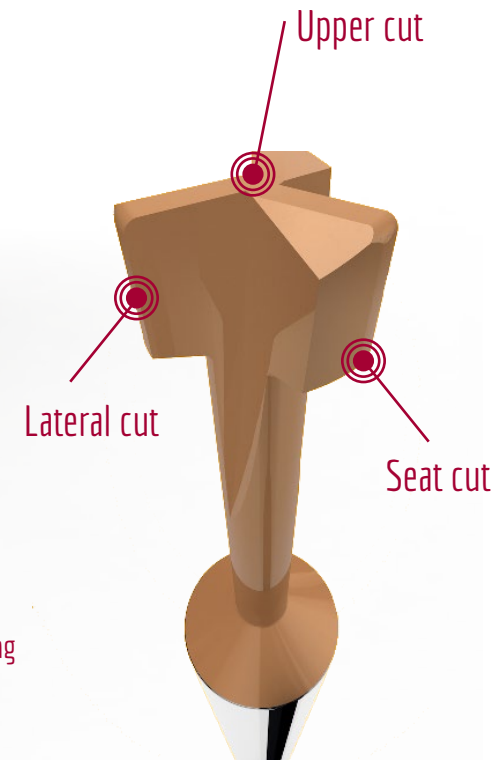

Useful length

Cutting area

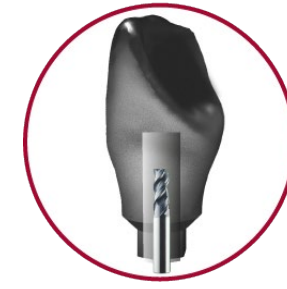

**STEP 1:**  
Crown with pre drill.



**STEP 2:**  
Crown with Angled channel.

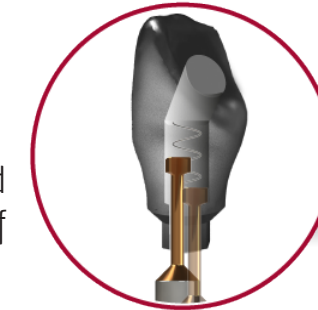

**STEP 3:**  
Crown with Dynamic Milling Tool. Milling the screw seat and increasing the diameter of the straight channel.

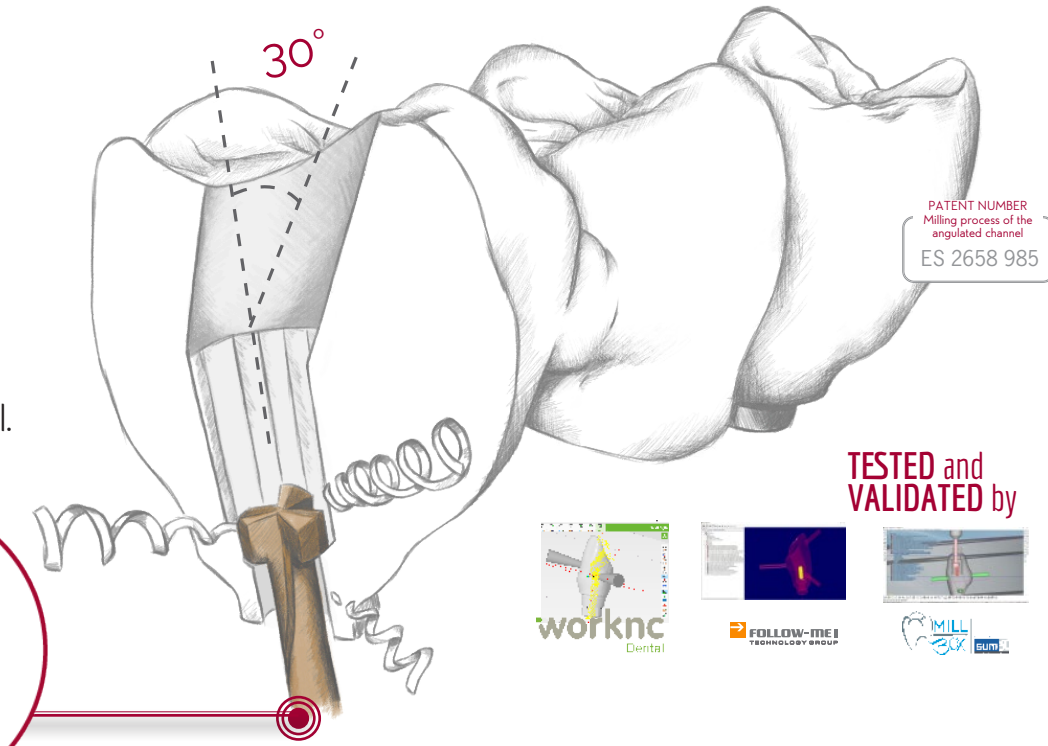

PATENT NUMBER  
Milling process of the angulated channel  
ES 2658 985

TESTED and VALIDATED by



If it is required to validate the internal geometry of the channel there are special green validation screws that are manufactured with a head diameter and length greater than the nominal one.

# VALIDATION DYNAMIC SCREW

\*Direct to implant maximum angulation under development

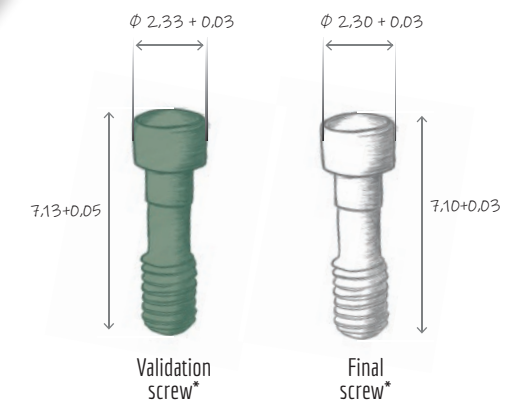

\*Screw model 41.317.071.01-2

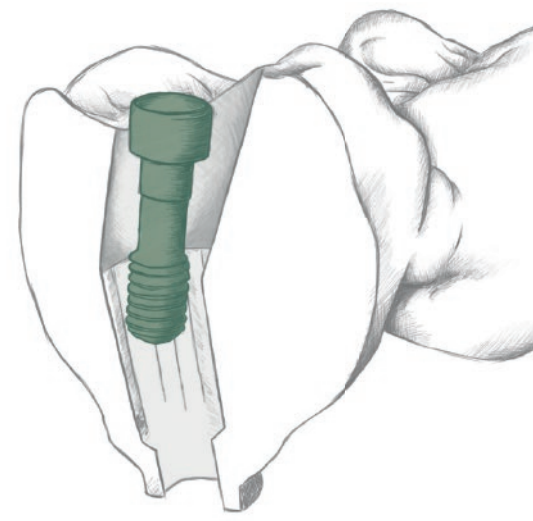

# DIGITAL ANALOG

Digital analog of the dental implant to simulate implant position in a 3D printed dental model.



**Concave notch**  
Top precision in longitudinal position

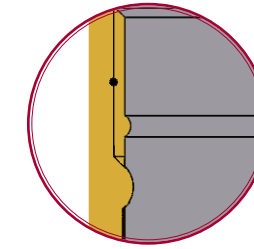

**Curved Surface**  
Accuracy of orientation guaranteed

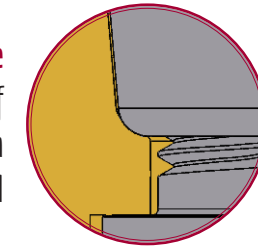

**Longitudinal cut**  
Longitudinal cut to avoid rotation X-Y

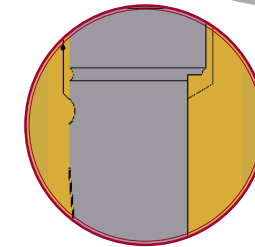

**Screwed fastening**  
Prevents the analog from moving in Z

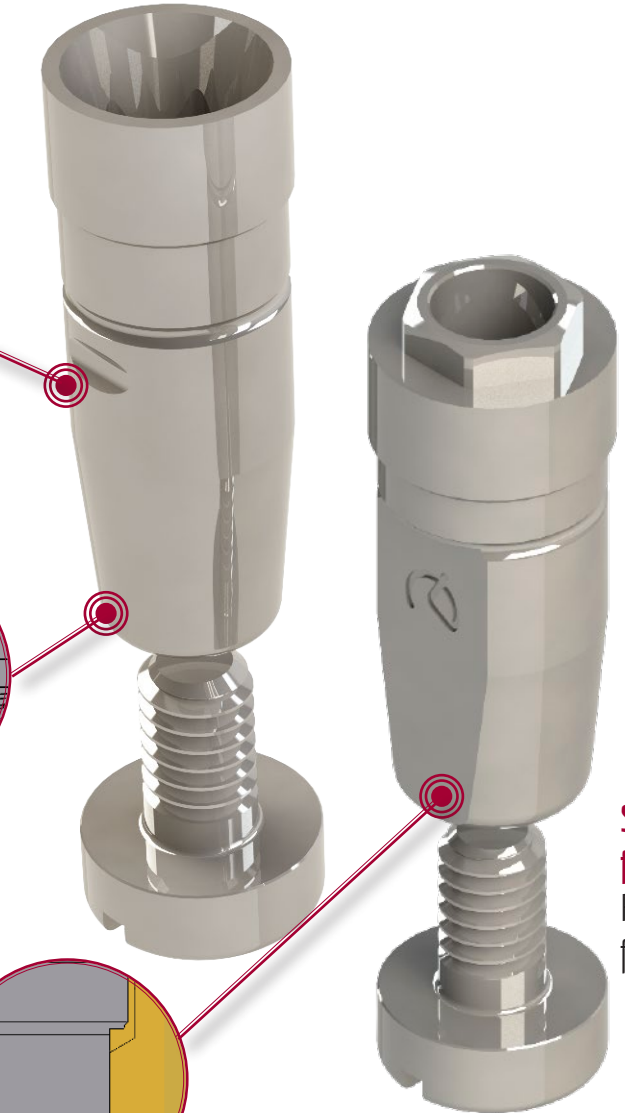

3shape  
Model Builder

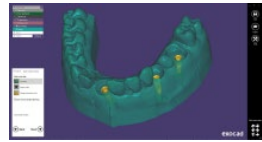

exocad  
Model Creator

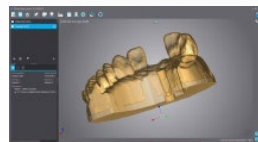

dental wings  
Model Builder

## 3D PRINTED MODEL

The dental model - for later insertion of the analogs - is designed using the CAD libraries.

## TIBASE VALIDATION PATTERN

The validation pattern for Ti-Base is an .stl file that contains different cement gaps between the Ti-Base and the material, ranging from 50 microns -which comes by default in the library- to values of 10, 20, 30, 40, 60, 70 and 80 microns.

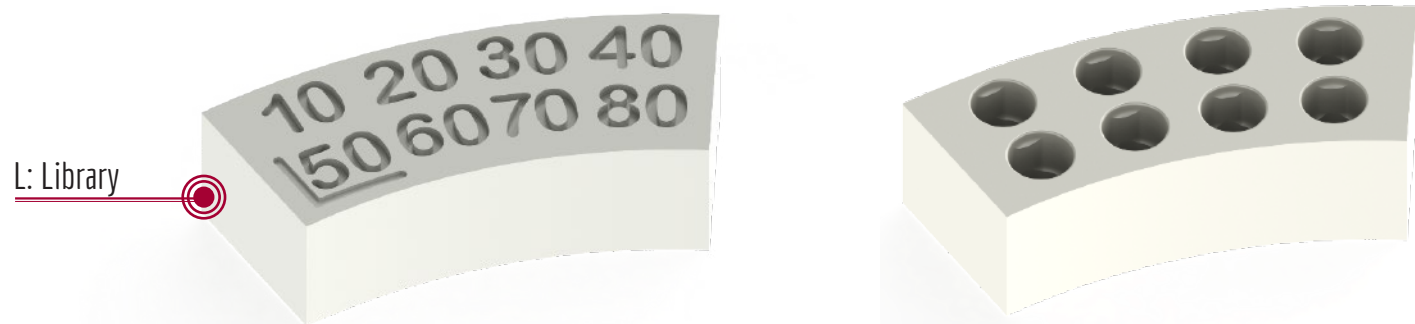

L: Library

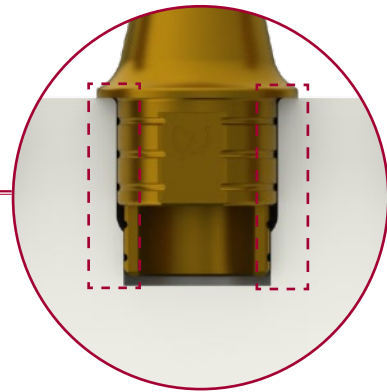
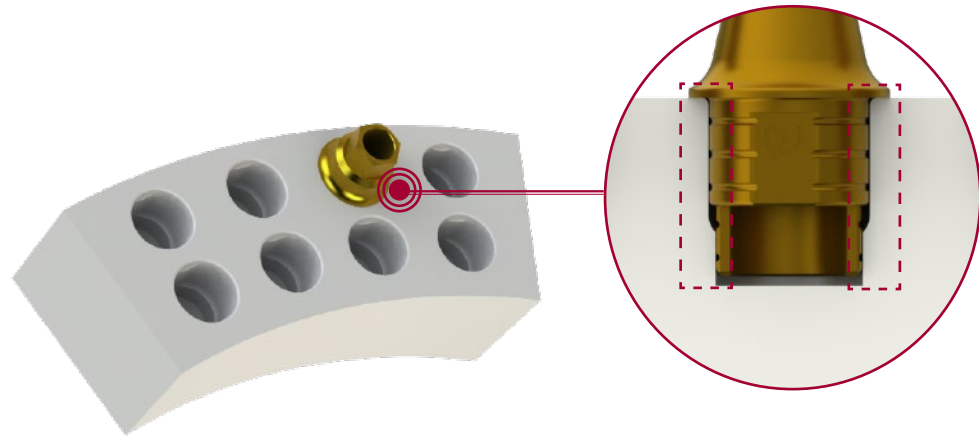

This pattern is to establish the cementation space, according to the client's convenience, for each case between the Ti-Base and the material.

## DIGITAL ANALOG VALIDATION PATTERN

The validation pattern for digital analogs is an .stl file that contains different printing gaps between the Digital Analog and the printing material, ranging from 30 microns -which comes by default in the library- to values of -10, 10, 50 and 70 microns.

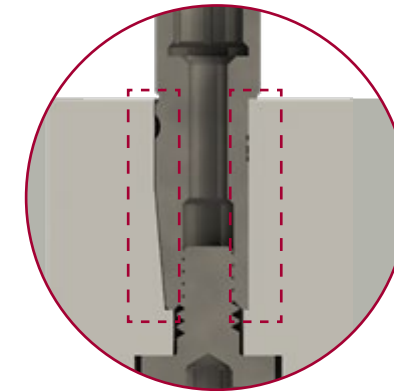

This pattern is used to know which is the ideal gap for the printer being used.

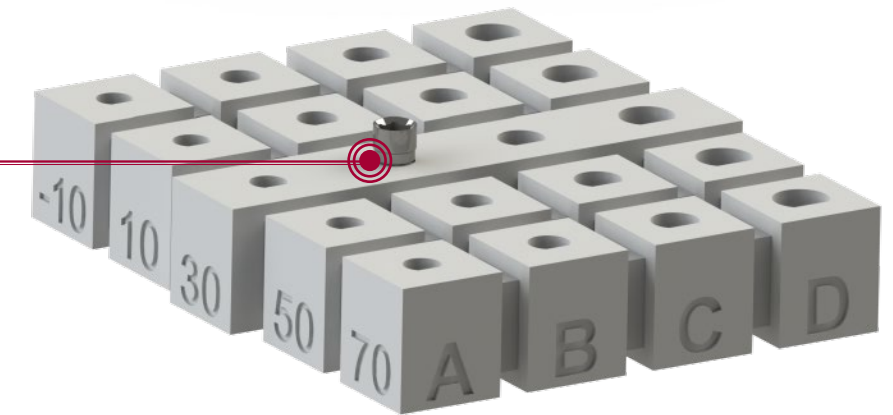

# DAS LIBRARIES

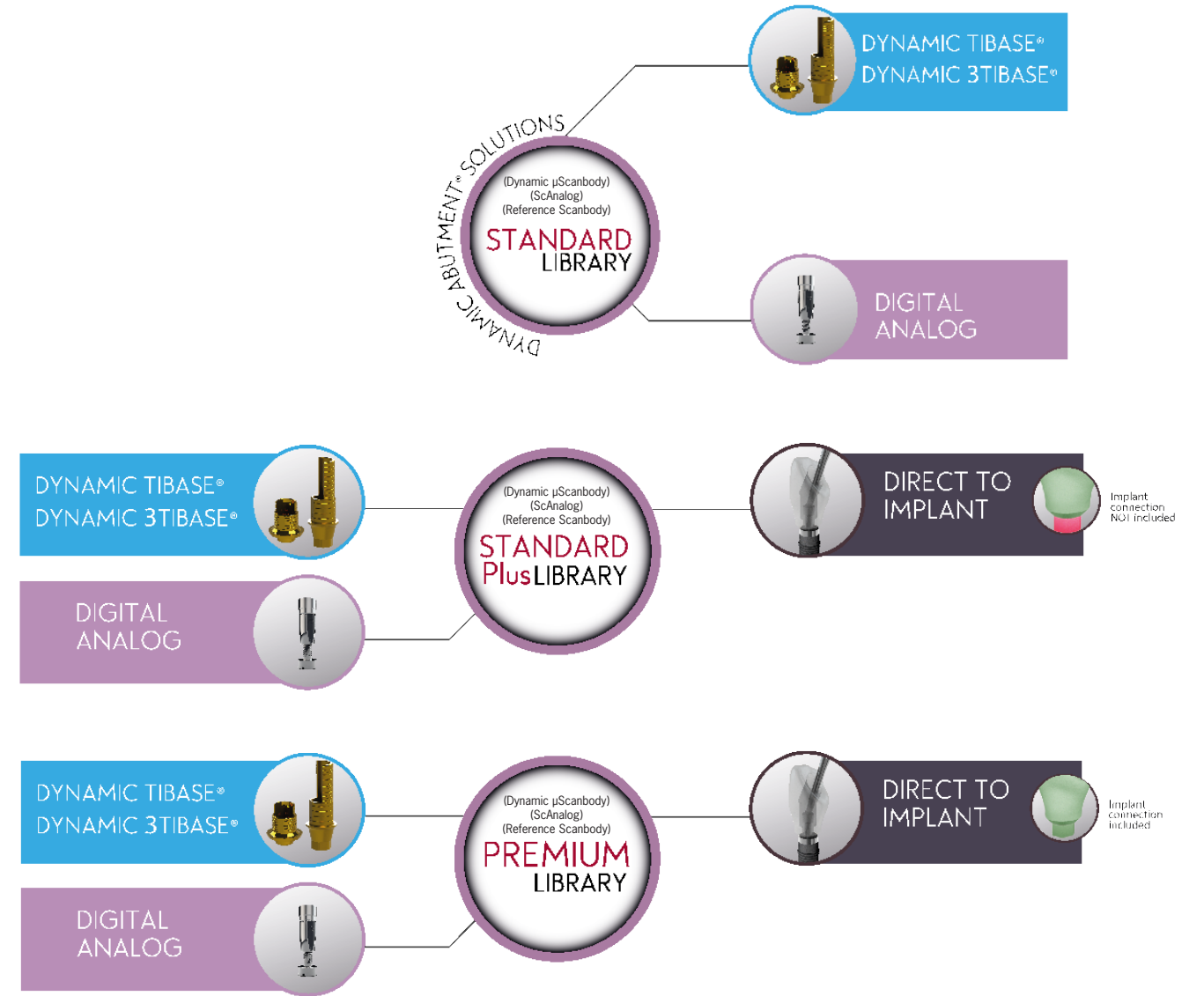
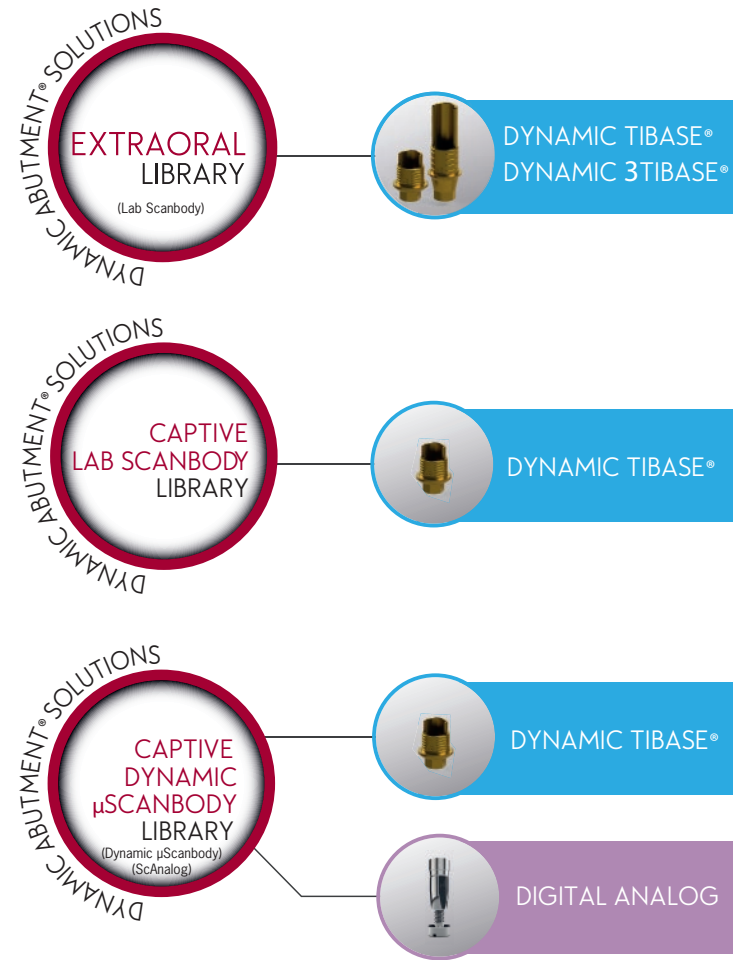

# IMPLANT PLANNING

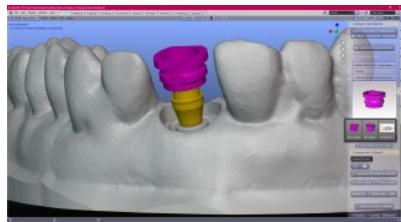
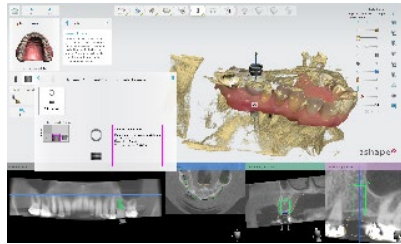
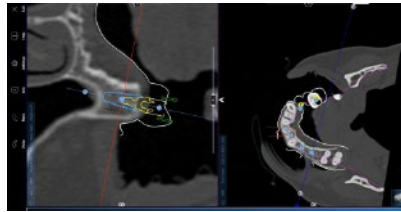
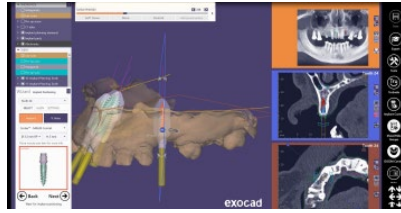
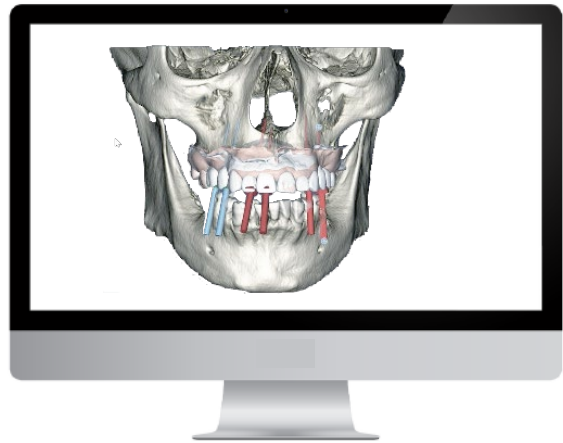

exoplan

3DIEMME  
BIOMAGING TECHNOLOGIES

RealGUIDE  
UNIVERSAL OPEN SYSTEM

3shape  
Implant Studio

blenderfordental

# DYNAMIC TIBASE®

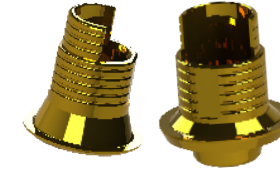

CAD

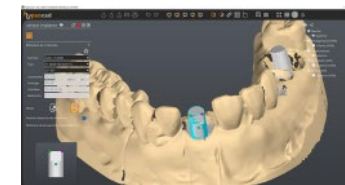
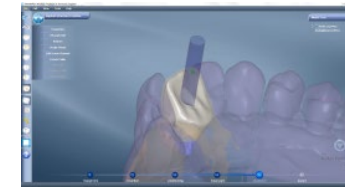
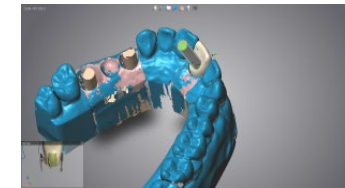
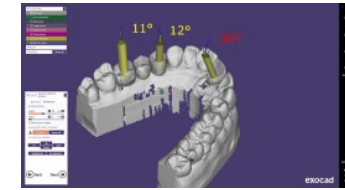
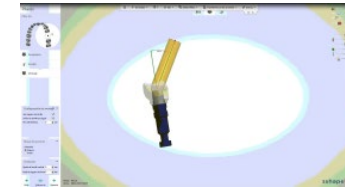

3shape

exocad

dental wings

DentalCad

hypsoCAD

CAM

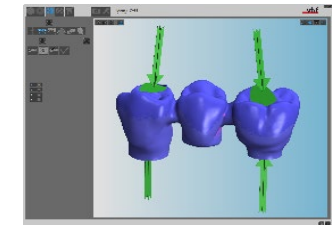
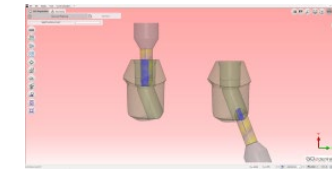
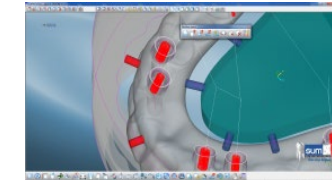
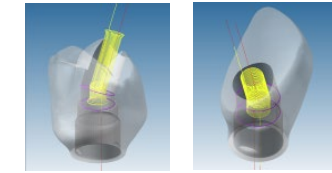
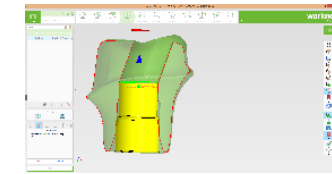

Tested CAM Software

worknc  
Dental

FOLLOW-ME!  
TECHNOLOGY GROUP

MILL BOX  
sum

GO2dental  
cam for dental labs

vhf



# DIRECT to IMPLANT

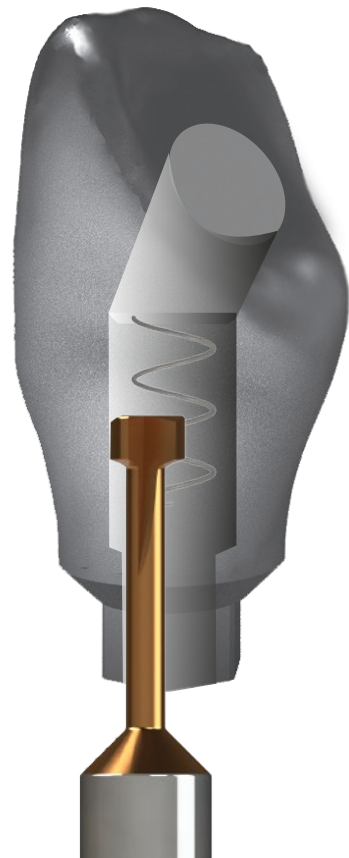

## CAD

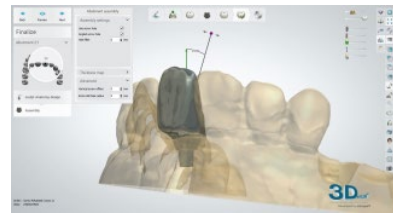

3shape

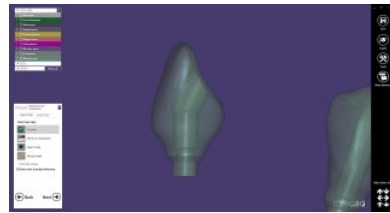

exocad



dental wings

## CAM

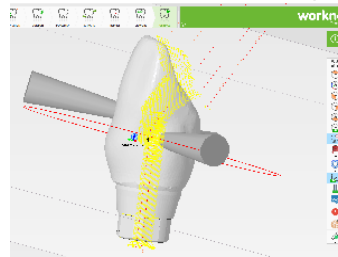

worknc  
Dental

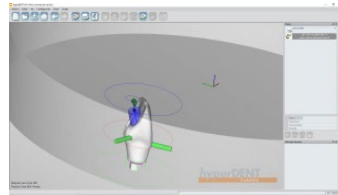

FOLLOW-ME!  
TECHNOLOGY GROUP

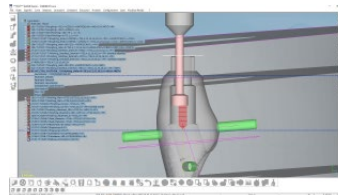

MILL BOX  
sum

# DIGITAL ANALOG



## CAD-CAM



3shape  
Model Builder

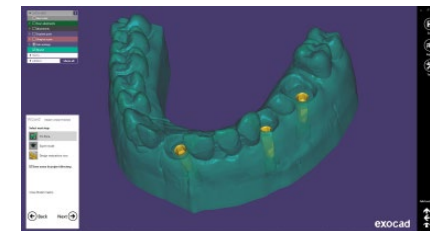

exocad  
Model Creator

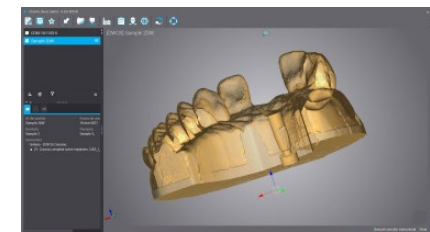

dental wings  
Model Builder

DYNAMIC ABUTMENT\* SOLUTIONS

# DYNAMIC DASSYSTEM



## LIST OF COMPATIBILITIES AVAILABLE

AB	BIOTEC	ECKERMANN	IMPLANTSWISS	NORMON	SOLUTIONS
ACE	BRENT MEDICAL	ELITE MEDICA	INTRA-LOCK	NOVA IMPLANTS	TBR
ADIN	BTI	EUROTEKNIKA	JDENTALCARE	OSSTEM IMPLANT	TITANIUM-FIX
ALFA-GATE	BTK	F&B IMPLANT (FIT & BRILLIANT)	KEYSTONE	OSTEOPLUS	TREE-OSS
ALPHABIO	CAMLOG	GALIMPLANT	KLOCKNER	OXY	TRI DENTAL IMPLANTS
ANCLADEN	CONEXÃO SISTEMA DE PROTESE	GC TECH	LASAK	PALTOP	TRINON
ANKYLOS	CORTEX	GLOBAL D (TEKKA)	LEADER	PHIBO	UFIT
ANTHOGRYR	COWELLMEDI	GMI (ILERIMPLANT)	MEDENTIKA	PROCLINIC	VULKAN IMPLANTS
ARDS	C-TECH	GT MEDICAL	MEDENTIS	RADHEX	WIN
ASTRA	DENTAL TECH	HAHN IMPLANT (GLIDEWELL)	MEGAGEN	REFLECT	XIVE
AVINENT	DENTAURUM	HIOSSSEN	MICRODENT	SEWON MEDIX	YES IMPLANT
B&W	DENTEGRIS	HI-TEC	MIS	SIC INVENT	ZIACOM
BEGO	DENTIS	IBS	MOZO-GRAU (TICARE)	SIGNO VINCES	ZIMMER
BIOCONCEPT	DENTIUM	IDO IMPLANTS	MPI	SIN IMPLANTS	
BIOGENESIS	DIO IMPLANTS	IHDE DENTAL (IMBIODENT)	NEOBIOTECH	SOUTHERN IMPLANTS	
BIOHORIZONS	DMI DENTAL SUPPLY	IMPLANT DIRECT	NEODENT	STERI-OSS	
BIOLOK	DSP BIOMEDICAL	IMPLANT GENESIS	NEOSS	STERNGOLD	
BIOMET 3i	EASY IMPLANT		NOBEL BIOCARE	STRAUMANN	
BIONER			NORIS MEDICAL	SYBRON IMPLANT	

## COMPATIBILITIES AVAILABLE

BRAND	MODEL	IMPLANT Ø	PLATFORM	ROTATION	COMPATIBILITY CODE
AB	I2	3,5/3,75/4,2/4,5/	Standard	R/NR	0040
AB	I2	5/6	Standard	R/NR	0040
AB	I22	3,75/4,22	Standard	R/NR	0040
AB	I5	3,5/3,75/4,2/4,5/	Standard	R/NR	0040
AB	I5	5/6/7/8	Standard	R/NR	0040
AB	I55	3,75/4,2/4,5	Standard	R/NR	0040
AB	I55	5/6/7/8	Standard	R/NR	0040
AB	I10	4,2/5	Standard	R/NR	0040
AB	I15	6/7/8	Standard	R/NR	0040
AB	Multi Unit D1-P64	Multi Unit D1-P64	Universal	R	0025
ACE	External Hex	3,3	NP 3,5	R/NR	0023
ACE	External Hex	3,75/4	RP 4,1	R/NR	0024
ACE	External Hex	4,75	WP 5	R/NR	0058
ACE	Infinity TRI-CAM	3,5	3,5	R/NR	0026
ACE	Infinity TRI-CAM	4,3	4,3	R/NR	0027
ACE	Infinity TRI-CAM	5	5	R/NR	0028
ACE	Infinity Internal Hex	3,7/4,1	3,5	R/NR	0040
ACE	Infinity Internal Hex	4,7/5,1	4,5	R/NR	0041
ACE	Infinity Octagon	3,3	RP 4,8	R/NR	0037
ACE	Infinity Octagon	4,1	RP 4,8	R/NR	0037
ACE	Infinity Octagon	4,8	RP 4,8	R/NR	0037
ACE	Infinity Octagon	4,8	WP 6,5	R/NR	0096
ACE	Multi Unit	Universal	Universal	R	0025
ADIN	Swell	3,3	3,45	R/NR	0040

## COMPATIBILITIES AVAILABLE

BRAND	MODEL	IMPLANT Ø	PLATFORM	ROTATION	COMPATIBILITY CODE
ADIN	Swell	3,75/4,2	3,6	R/NR	0040
ADIN	Swell	5	4	R/NR	0040
ADIN	Swell	6	4,6	R/NR	0040
ADIN	Touareg-S / Touareg-OS	3,5	3,45	R/NR	0040
ADIN	Touareg-S / Touareg-OS	3,75/4,2	3,6	R/NR	0040
ADIN	Touareg-S / Touareg-OS	5	4	R/NR	0040
ADIN	Touareg-S / Touareg-OS	6	5	R/NR	0040
ADIN	Touareg CloseFit	2,75	UNP	R/NR	0188
ADIN	Touareg CloseFit	3,5	RP	R/NR	0021
ADIN	Touareg CloseFit	4,3/5	WP	R/NR	0022
ADIN	Swell	3,3	3,45	ZIO	0042
ADIN	Swell	3,75/4,2	3,6	ZIO	0042
ADIN	Swell	5	4	ZIO	0042
ADIN	Swell	6	4,6	ZIO	0042
ADIN	Touareg-S / Touareg-OS	3,5	3,45	ZIO	0042
ADIN	Touareg-S / Touareg-OS	3,75/4,2	3,6	ZIO	0042
ADIN	Touareg-S / Touareg-OS	5	4	ZIO	0042
ADIN	Touareg-S / Touareg-OS	6	5	ZIO	0042
ADIN	Touareg CloseFit	3		R	0145
ADIN	Touareg CloseFit	3	NP	NR	0145
ADIN	Multi Unit TMA	Universal	Universal	R	0025
ALFA-GATE	Bioactive S-line/SLA	3,3/3,75/4,2/4,7/5,2/6	3,75	R/NR	0040
ALFA-GATE	Conical	3,5	NP	R/NR	0021
ALFA-GATE	Conical	4,3/5	RP	R/NR	0022

## COMPATIBILITIES AVAILABLE

BRAND	MODEL	IMPLANT Ø	PLATFORM	ROTATION	COMPATIBILITY CODE
ALPHABIO	Internal Hex Connection (IH) SPI	3,3/3,75/4,2/5/6	Universal	R/NR	0040
ALPHABIO	Internal Hex Connection (IH) ICE	3,7/3,75/4,2/4,65/5,3	Universal	R/NR	0040
ALPHABIO	Internal Hex Connection (IH) DFI	3,3/3,75/4,2/5	Universal	R/NR	0040
ALPHABIO	Internal Hex Connection (IH) ATID	3,3/3,75/4,2/5/6	Universal	R/NR	0040
ALPHABIO	Internal Hex Connection (IH) NEO	3,75/4,2/5	3,5	R/NR	0040
ALPHABIO	Conical Hex Connection (CHC) NICE	3,2	Narrow	R/NR	0136
ALPHABIO	Conical Hex Connection (CHC) NEO	3,2/3,5	Narrow	R/NR	0136
ALPHABIO	Conical Standard Connection (CS)	3,75/4,2/5	Standard	R/NR	0169
ALPHABIO	Multi Unit		Universal	R	0195
ANCLADEN	Anclalock	3,75/4,25/5	3,5	R/NR	0040
ANKYLOS	Ankylos	3,5	3,5	R	0075
ANKYLOS	Ankylos	4,5	4,5	R	0075
ANKYLOS	Ankylos	5,5	5,5	R	0075
ANKYLOS	Ankylos	7	7	R	0075
ANKYLOS	Balance Base Narrow	Universal	Universal	R	0183
ANTHOGYR	Axiom REG / PX	3,4	3,4	R/NR	0161
ANTHOGYR	Axiom REG / PX	4	4	R/NR	0149
ANTHOGYR	Axiom REG / PX	4,6	4,6	R/NR	0149
ANTHOGYR	Axiom REG / PX	5,2	5,2	R/NR	0162
ANTHOGYR	Anthofit HE	3,5/3,75/4	R (4,1)	R/NR	0024
ANTHOGYR	Anthofit HE	5	L (5)	R/NR	0058
ANTHOGYR	Ossfit	3,5/4,2	4,8	R/NR	0074
ANTHOGYR	Ossfit	3,5/4,2	4,8	R/NR	0037
ANTHOGYR	Ossfit	5	6,5	R/NR	0096

## COMPATIBILITIES AVAILABLE

BRAND	MODEL	IMPLANT Ø	PLATFORM	ROTATION	COMPATIBILITY CODE
ANTHOGYR	Multi Unit	4,8	Universal	R	0163
ARDS	Smart	3,75/4,2/4,5	3,75	R/NR	0040
ARDS	Classic	3,3/3,75/4,2/5/6	3,75	R/NR	0040
ARDS	Premium	3,3/3,75/4,2/5/6	3,75	R/NR	0040
ARDS	CIT	3,3/3,75/4,2/5/6	3,75	R/NR	0040
ASTRA	Yellow	3	Yellow (X-estrecha)	R/NR	0109
ASTRA	Aqua	3,5/4	Aqua(Estrecha)	R/NR	0004
ASTRA	Lilac	4,5/5	Lilac (Ancha)	R/NR	0005
ASTRA	Evolution (Interno)	3	3.0	R/NR	0090
ASTRA	Evolution (Interno)	3,6	3.6	R/NR	0006
ASTRA	Evolution (Interno)	4,2	4.2	R/NR	0007
ASTRA	Evolution (Interno)	4,8	4.8	R/NR	0091
ASTRA	Evolution (Interno)	5,4	5.4	R/NR	0092
ASTRA	Uniabutment Cono 20o	Regular/Wide	Regular/Wide	R	0066
ASTRA	Evolution (Cono externo 33°)		Universal	R	0008
ASTRA	Multibase Abutment (SmartFix concept)		Universal	R	0258
AVINENT	HE/EC	3,3//3,5/4	3,5	R/NR	0023
AVINENT	HE/EC	3,3/3,8/4/4,2/4,8//4,5/5	4,1	R/NR	0024
AVINENT	HE/EC	4,8	5,1	R/NR	0061
AVINENT	HI/IC	3,1//3,5/4	3,5	R/NR	0040
AVINENT	HI/IC	3,3/3,8/4/4,2/4,8//4,5/5	4,1	R/NR	0040
AVINENT	Transepitelial		Regular	R	0025
B&W	Hexágono Externo	3,75/4	4,1	R/NR	0024
B&W	Hexágono Externo	5	5	R/NR	0058

## COMPATIBILITIES AVAILABLE

BRAND	MODEL	IMPLANT Ø	PLATFORM	ROTATION	COMPATIBILITY CODE
B&W	Cónico Hexagono Interno CIH	3,3/4		ZIO	0042
B&W	Cónico Hexagono Interno CIH	3,3/4		R	0040
BEGO	RS/RSX	3.0		R/NR	0049
BEGO	S/RI/RS/RSX	3,25/3,75		R/NR	0050
BEGO	S/RI/RS/RSX	4,1		R/NR	0051
BEGO	S/RI/RS/RSX	4,5		R/NR	0052
BEGO	S/RI/RS/RSX	5,5		R/NR	0081
BEGO	Mini	2,7/2,9/3,1		Mini	0187
BEGO	MultiPlus			Universal	0150
BIOCONCEPT	BC Tissue Level Standard	3,3/4,1/4,8		Regular	R/NR
BIOCONCEPT	BC Tissue Level Standard Plus	4,8		Regular	R/NR
BIOCONCEPT	BC Tissue Level Tapered Effect	4,8		Regular	R/NR
BIOCONCEPT	BC Bone Level	3,3		Narrow	R/NR
BIOCONCEPT	BC Bone Level	4,1/4,8		Regular	R/NR
BIOCONCEPT	BV Tapered Bone Level	3,5		Narrow	R/NR
BIOCONCEPT	BV Tapered Bone Level	4/4,5/5		Regular	R/NR
BIOGENESIS	3icon	3,3		Mini (Pink)	R/NR
BIOGENESIS	3icon	3,75/4/4,3/4,5		Regular (Blue)	R/NR
BIOGENESIS	3icon	5/5,5		Wide (Yellow)	R/NR
BIOGENESIS	Aticon	3,5/4/4,5/5		Blue	R/NR
BIOGENESIS	Iticon	3,5/4,1/4,8		4,8	R/NR
BIOHORIZONS	External	3,5		3,7 (Yellow)	R/NR
BIOHORIZONS	Tapered Internal	3,8		3,5 (Yellow)	R/NR
BIOHORIZONS	Tapered Internal	4,6		4,5 (Green)	R/NR

## COMPATIBILITIES AVAILABLE

BRAND	MODEL	IMPLANT Ø	PLATFORM	ROTATION	COMPATIBILITY CODE
BIOHORIZONS	Tapered Internal	5,8		5,7 (Blue)	R/NR
BIOHORIZONS	Tapered Plus	4,6		3,5 (Yellow)	R/NR
BIOHORIZONS	Tapered Plus	5,8		4,5 (Green)	R/NR
BIOHORIZONS	Mount-free Tapered Internal	3,8		3,5 (Yellow)	R/NR
BIOHORIZONS	Mount-free Tapered Internal	4,6		4,5 (Green)	R/NR
BIOHORIZONS	Mount-free Tapered Internal	5,8		5,7 (Blue)	R/NR
BIOHORIZONS	Tapered Pro	4,2/4,6		3,5 (Yellow)	R/NR
BIOHORIZONS	Tapered Pro	5,2		4,5 (Green)	R/NR
BIOHORIZONS	Tapered Short	4,6		3,5 (Yellow)	R/NR
BIOHORIZONS	Tapered Short	5,8		4,5 (Green)	R/NR
BIOHORIZONS	Tapered PTG	4,2		3,5 (Yellow)	R/NR
BIOHORIZONS	Tapered IM (Immediate Molar)	7/8		5,7 (Blue)	R/NR
BIOHORIZONS	Tapered Tissue Level	3/3,8		3,5 (Yellow)	R/NR
BIOHORIZONS	Tapered Tissue Level	4,6		4,5 (Green)	R/NR
BIOHORIZONS	Tapered Tissue Level	5,8		5,7 (Blue)	R/NR
BIOHORIZONS	Multi Unit			Universal	R
BIOLOK	Hexágono Externo	3,45		3,45	R/NR
BIOMET 3i	Osseotite External Hex	3,25		3,4	R/NR
BIOMET 3i	Osseotite External Hex	3,75/4		4,1	R/NR
BIOMET 3i	Osseotite External Hex	5		5	R/NR
BIOMET 3i	Certain	3,25/4		3,4	R/NR
BIOMET 3i	Certain	4/5		4,1	R/NR
BIOMET 3i	Certain	5		5	R/NR
BIOMET 3i	Low Profile			Universal	R

## COMPATIBILITIES AVAILABLE

BRAND	MODEL	IMPLANT Ø	PLATFORM	ROTATION	COMPATIBILITY CODE
BIONER	Ikelt / Bikelt	3,3/3,75/4	4,1	R/NR	0024
BIONER	Ikelt	5	5	R/NR	0058
BIONER	Hikelt	3,8	3,95	R/NR	0040
BIONER	Hikelt	4,7	4,9	R/NR	0041
BIONER	TopDM	3,5	3,5	R/NR	0021
BIONER	TopDM	4	4	R/NR	0021
BIONER	TopDM	5	5	R/NR	0021
BIONER	Transepitelial A-5M	Transepitelial A-5M	Regular	R	0025
BIOTEC	SPR/CIM	3,75	3,75	R/NR	0040
BIOTEC	SPR/SPTT/CIM	4,2	4,2	R/NR	0040
BIOTEC	SPR/SPTT/CIM	5	5	R/NR	0040
BIOTEC	SPR/CIM	3,3	3,3	NR	0040
BIOTEC	SPR/CIM	3,3	3,3	R	0040
BREDENT MEDICAL	Narrow Sky	3,5	NP 3,5	R/NR	0110
BREDENT MEDICAL	Blue Sky	3,5/4/4,5/5,5	4	R/NR	0111
BREDENT MEDICAL	Blue Sky Classic	3,5/4/4,5	4	R/NR	0111
BREDENT MEDICAL	Copa Sky	3,5/4/4,5/5/6	3,3	R/NR	0251
BTI	Externa Tiny	2,5/3/3,3/3,5/3,75	Tiny 3,5	R/NR	0009
BTI	Externa Universal	3,75/4	Universal 4,1	R/NR	0024
BTI	Externa Universal Plus	4,5/5	Universal Plus 4,1	R/NR	0024
BTI	Externa	4,5/5/5,5	Ancha 5,5	R/NR	0060
BTI	Interna Universal	3,3/3,5/3,75/4/4,25	Universal 4,1	R/NR	0010
BTI	Interna Universal Plus	4,5/5/5,5	Universal Plus 4,1	R/NR	0010
BTI	Interna Ancha	5,5/6/6,25	Ancha 5,5	R/NR	0059

## COMPATIBILITIES AVAILABLE

BRAND	MODEL	IMPLANT Ø	PLATFORM	ROTATION	COMPATIBILITY CODE
BTI	Multi-IM	converter 4,1	Universal 4,1	R	0151
BTK	Klassic / Konic	3,25	3,4 EN	R/NR	0003
BTK	Klassic / Konic	3,25PL/3,75/4	4,1 ER	R/NR	0024
BTK	IS +	3,3/3,7/4,1/4,8/6	DR	R/NR	0029
BTK	BT Safe BL	3,3/3,7/4,1/4,8	KR	R/NR	0029
BTK	Klassic / Konic	3,25/4	3,5 IR	R/NR	0040
BTK	Klassic / Konic	3,25/4	3,5 IR	ZIO	0042
CAMLOG	Camlog Screw-Line/Progressive-Line	3,3	3,3	R/NR	0087
CAMLOG	Camlog Screw-Line/Progressive-Line	3,8	3,8	R/NR	0011
CAMLOG	Camlog Screw-Line/Progressive-Line	4,3	4,3	R/NR	0012
CAMLOG	Camlog Screw-Line/Progressive-Line	5	5	R/NR	0088
CAMLOG	Camlog Screw-Line/Progressive-Line	6	6	R/NR	0089
CAMLOG	Conelog Screw-Line/Progressive-Line	3,3	3,3	R/NR	0119
CAMLOG	Conelog Screw-Line/Progressive-Line	3,8	3,8	R/NR	0120
CAMLOG	Conelog Screw-Line/Progressive-Line	4,3	4,3	R/NR	0121
CONEXÃO SISTEMA DE PRÓTESE	Flash	3,5/4,3/5	Universal	R/NR	0021
CONEXÃO SISTEMA DE PRÓTESE	Torq	3,5/3,75/4	Universal	R/NR	0021
CONEXÃO SISTEMA DE PRÓTESE	Expand	3,75/4/5	Universal	R/NR	0021
CORTEX	Internal Hex Dynamix	3,3/3,8/4,2/5/6	3,75	R/NR	0040
CORTEX	Internal Hex Classix	3,3/3,8/4,2/5/6	3,75	R/NR	0040
CORTEX	Internal Hex Saturn	3,8/4,2	3,5	R/NR	0040
CORTEX	Conical Dynamix	3	NP	R/NR	0109
CORTEX	Conical Dynamix	3,3/3,8/4,2	RP	R/NR	0004
CORTEX	Conical Dynamix	5/6	WP	R/NR	0005

## COMPATIBILITIES AVAILABLE

BRAND	MODEL	IMPLANT Ø	PLATFORM	ROTATION	COMPATIBILITY CODE
CORTEX	Conical Classix	3,3/3,8/4,2	RP	R/NR	0004
CORTEX	Conical Classix	5/6	WP	R/NR	0005
CORTEX	Conical Magix	3,3/3,8/4,2	RP	R/NR	0004
CORTEX	Multi Unit		Universal	R	0025
COWELLMEDI	Inno - External Type	5,0/6,0	5,1	R/NR	0061
COWELLMEDI	Multi S&A Abutment Ø 4,5 mm	Multi S Abutment	Universal	R	0193
C-TECH	EL Esthetic Line	3,8/4,3/5,1	4	R/NR	0246
C-TECH	Multi Unit		Universal	R	0245
DENTAL TECH	Implogic	4,5	4,5 (Blue)	R/NR	0041
DENTAURUM	Tiologic	3,3	Small	R/NR	0130
DENTAURUM	Tiologic	3,7/4,2	Medium	R/NR	0131
DENTAURUM	Tiologic	4,8/5,5	Large	R/NR	0132
DENTEGRIS	SLS-Straight	4,5	4,5	R/NR	0041
DENTEGRIS	Sinus-Lift	4,5	4,5	R/NR	0041
DENTEGRIS	S&T Implants	4,5	4,5	R/NR	0041
DENTIS	OneQ-SL	3	Narrow	R/NR	0014
DENTIS	OneQ-SL	3,9/4,2/4,7/5,2	Regular	R/NR	0030
DENTIS	OneQ-SL	6/7/8	Wide	R/NR	0030
DENTIS	s-Clean Tapered / Tapered II	3,7	Mini	R/NR	0030
DENTIS	s-Clean Tapered / Tapered II	4,1/4,3	Regular	R/NR	0030
DENTIS	s-Clean Tapered / Tapered II	4,8	Wide	R/NR	0030
DENTIS	s-Clean Straight	4,1/4,8	4,1/4,8	R/NR	0030
DENTIS	s-Clean Save	5,5/6	5,5/6	R/NR	0030
DENTIS	SQ-SL	3,5	Narrow	R/NR	0014

## COMPATIBILITIES AVAILABLE

BRAND	MODEL	IMPLANT Ø	PLATFORM	ROTATION	COMPATIBILITY CODE
DENTIS	SQ-SL	4/4,5/5	Regular	R/NR	0030
DENTIS	SQ-SL	6/7/8	Wide	R/NR	0030
DENTIS	e-Clean	3,5	Mini	R/NR	0023
DENTIS	e-Clean	4,1	Regular	R/NR	0024
DENTIS	e-Clean	5,1	Wide	R/NR	0061
DENTIS	i-Clean Tapered	3,7	Mini	R/NR	0037
DENTIS	i-Clean Tapered	4,1/4,3	Regular	R/NR	0037
DENTIS	i-Clean Tapered	4,8	Wide	R/NR	0037
DENTIS	i-Clean Straight	4,1/4,8	4,8	R/NR	0037
DENTIS	Octa Abutment	Universal	Universal	R/NR	0074
DENTIUM	NR Line	3,1	3,2	R/NR	0190
DENTIUM	NR Line	3,1	3,6	R/NR	0190
DENTIUM	NR Line	3,6	3,6	R/NR	0191
DENTIUM	NR Line	4,3	4,3	R/NR	0191
DENTIUM	NR Line	5	5	R/NR	0191
DENTIUM	NR Line	6	6	R/NR	0191
DENTIUM	SimpleLine II	3,8/4,3	4,8	R/NR	0074
DENTIUM	SimpleLine II	3,8/4,3	4,8	R/NR	0037
DENTIUM	SimpleLine II	4,3/4,8	6,5	R/NR	0096
DENTIUM	SuperLine and Implantium	3,4	3,6	R/NR	0030
DENTIUM	SuperLine and Implantium	3,8	4	R/NR	0030
DENTIUM	SuperLine and Implantium	4,3	4,5	R/NR	0030
DENTIUM	SuperLine and Implantium	4,8	5	R/NR	0030
DENTIUM	SuperLine and Implantium	4,8	6	R/NR	0030

## COMPATIBILITIES AVAILABLE

BRAND	MODEL	IMPLANT Ø	PLATFORM	ROTATION	COMPATIBILITY CODE
DENTIUM	Multi Unit NR Line		5	R	0192
DENTIUM	Multi Unit Superline and Implantium		4,5	R	0193
DIO IMPLANTS	SM System	4,5/5/5,3	Regular/Wide	R/NR	0013
DIO IMPLANTS	UF II Narrow	3/3,3	Narrow	R/NR	0014
DIO IMPLANTS	UF II	3,8/4/4,5/5/5,5	Regular	R/NR	0030
DIO IMPLANTS	External	3,3/3,8	Narrow 3,5	R/NR	0023
DIO IMPLANTS	External	3,75/4/4,5	Regular 4,1	R/NR	0024
DIO IMPLANTS	External	5/5,3/5,5/6	Wide 5,1	R/NR	0061
DIO IMPLANTS	Internal OCTA		4.8	R/NR	0074
DIO IMPLANTS	Multi Unit		Universal	R	0247
DMI DENTAL SUPPLY	DCI/DSI	3,3/3,5/3,75/4,2/5/6	3,75	R/NR	0040
DSP BIOMEDICAL	Hexágono Externo	3,75/4/5//3,5/3,8/4,3	4,1	R/NR	0024
EASY IMPLANT	Master C	3,5	3,5 (Ocean)	R/NR	0004
EASY IMPLANT	Master C	4	4 (Ocean)	R/NR	0004
EASY IMPLANT	Master C	4,5	4,5 (Lilas)	R/NR	0030
EASY IMPLANT	Master C	5	5 (Lilas)	R/NR	0030
EASY IMPLANT	Master S	3,3	3,3 (Ocean)	R/NR	0004
EASY IMPLANT	Master S	3,75	3,75 (Lilas)	R/NR	0030
EASY IMPLANT	Master S	4,25	4,25 (Lilas)	R/NR	0030
EASY IMPLANT	Master S	4,75	4,75 (Lilas)	R/NR	0030
EASY IMPLANT	Master L	3,3	3,3 (Lilas)	R/NR	0030
EASY IMPLANT	Master L	3,75	3,75 (Lilas)	R/NR	0030
EASY IMPLANT	Master L	4,25	4,25 (Lilas)	R/NR	0030
EASY IMPLANT	Master L	4,75	4,75 (Lilas)	R/NR	0030

## COMPATIBILITIES AVAILABLE

BRAND	MODEL	IMPLANT Ø	PLATFORM	ROTATION	COMPATIBILITY CODE
EASY IMPLANT	Hexcel-S	3,3	3,3	R/NR	0003
EASY IMPLANT	Hexcel-S	3,75	4,1	R/NR	0024
EASY IMPLANT	Hexcel-S	4,25	4,1	R/NR	0024
EASY IMPLANT	Hexcel-S	4,75	5	R/NR	0058
EASY IMPLANT	MINI	3	3	NR	0176
EASY IMPLANT	Multi Unit Conical Abutment		Universal	R	0025
ECKERMANN	Hexagon	3/3,5/4/4,5/5	4,1	R/NR	0024
ECKERMANN	Winner	3/3,5/4	3,5	R/NR	0040
ECKERMANN	Winner	4/4,5/5	4,5	R/NR	0041
ECKERMANN	Winner	3/3,5/4	3,5	ZIO	0042
ECKERMANN	Winner	4/4,5/5	4,5	ZIO	0043
ELITE MEDICA	Conexión Externa	3,75	Narrow	R/NR	0023
ELITE MEDICA	Conexión Externa	4	Regular	R/NR	0024
ELITE MEDICA	Conexión Externa	5	Wide	R/NR	0061
EUROTEKNIKA	Naturactis	3,5	3,4	R/NR	0004
EUROTEKNIKA	Naturactis	4	3,8	R/NR	0004
EUROTEKNIKA	Naturactis	4,5	4,3	R/NR	0004
EUROTEKNIKA	Naturactis	5	4,8	R/NR	0004
EUROTEKNIKA	Uneva	3,6	4,1	R/NR	0024
EUROTEKNIKA	Uneva	4,1	4,1	R/NR	0024
EUROTEKNIKA	Uneva (Platform Switching)	4,8	4,1	R/NR	0024
EUROTEKNIKA	Uneva (Platform Switching)	6	4,1	R/NR	0024
EUROTEKNIKA	Natea	3,6/4,1/4,8	Narrow	R/NR	0004
EUROTEKNIKA	Natea	3,6/4,1/4,8	Regular	R/NR	0004



## COMPATIBILITIES AVAILABLE

BRAND	MODEL	IMPLANT Ø	PLATFORM	ROTATION	COMPATIBILITY CODE
EUROTEKNIKA	Natea	6	Wide	R/NR	0004
EUROTEKNIKA	Aesthetica	4,1	4,8	R/NR	0074
EUROTEKNIKA	Aesthetica	4,1	4,8	R/NR	0037
EUROTEKNIKA	Aesthetica	4,8	6,5	R/NR	0096
EUROTEKNIKA	Naturall	3,5	Narrow	R/NR	0004
EUROTEKNIKA	Naturall	4/4,5	Regular	R/NR	0004
EUROTEKNIKA	Naturall	5	Wide	R/NR	0004
EUROTEKNIKA	Multi Unit Tetra	Universal	Universal	R	0025
F&B IMPLANT (FIT & BRILLIANT)	FA Submerged Fixture	3,9	Narrow	R/NR	0030
F&B IMPLANT (FIT & BRILLIANT)	FA Submerged Fixture	4,1/4,4	Regular	R/NR	0030
F&B IMPLANT (FIT & BRILLIANT)	FA Submerged Fixture	4,8	Wide	R/NR	0030
F&B IMPLANT (FIT & BRILLIANT)	FA Submerged Fixture	5,3/5,8/6,3/6,8	Ultra-Wide	R/NR	0030
GALIMPLANT	Conexión Externa	3,5/4	4	R/NR	0024
GALIMPLANT	Conexión Interna	3,5	3,5	R/NR	0004
GALIMPLANT	Conexión Interna	4	4	R/NR	0004
GALIMPLANT	Conexión Interna	5	5	R/NR	0004
GALIMPLANT	Pilar multi-posicion recto/Pilar multi-posicion angulado	Universal	Universal	R	0025
GC TECH	AADVA Standard / Tapered Implants	3,3	Narrow	R/NR	0196
GC TECH	AADVA Standard / Tapered Implants	4	Regular	R/NR	0197
GC TECH	AADVA Standard / Tapered Implants	5	Wide	R/NR	0198
GLOBAL D (TEKKA)	In-Kone Universal	3,5/4/4,5/5	Universal	R/NR	0152
GLOBAL D (TEKKA)	In-Kone Primo	3,5/4/4,5/5	Universal	R/NR	0152
GMI (ILERIMPLANT)	Phoenix	3,3/3,75/4	Standard 4,1	R/NR	0024
GMI (ILERIMPLANT)	Phoenix	5	Wide 5,1	R/NR	0061

## COMPATIBILITIES AVAILABLE

BRAND	MODEL	IMPLANT Ø	PLATFORM	ROTATION	COMPATIBILITY CODE
GMI (ILERIMPLANT)	Frontier	3,3/3,75/4,25	RP 3,3	R/NR	0040
GMI (ILERIMPLANT)	Frontier	4,75/5,75	WP 4,3	R/NR	0041
GMI (ILERIMPLANT)	Universal	Universal	PS-RP 4,8	R	0025
GT MEDICAL	Best Fit Octógono Interno	3,7/4,3/4,8	Regular	R/NR	0074
GT MEDICAL	Best Fit Octógono Interno	3,7/4,3/4,8	Regular	R/NR	0037
GT MEDICAL	Best Fit Hexágono Interno	3,7/4,1/4,3/4,8	Wide	R/NR	0005
GT MEDICAL	Best Fit Hexágono Externo	3,5	Narrow	R/NR	0023
GT MEDICAL	Best Fit Hexágono Externo	4,1	Regular	R/NR	0024
GT MEDICAL	Best Fit Hexágono Externo	5,1	Wide	R/NR	0061
HAHN IMPLANT (GLIDEWELL)	Hahn Tapered Implant	3,5/4,3	3,5/4,3	R/NR	0021
HAHN IMPLANT (GLIDEWELL)	Hahn Tapered Implant	5	5	R/NR	0022
HAHN IMPLANT (GLIDEWELL)	Hahn Tapered Implant	7	7	R/NR	0124
HAHN IMPLANT (GLIDEWELL)	Multi-Unit Abutment system	Universal	Universal	R	0025
HIOSEN	ETII SA / ETIII SA	3,5	Mini	R/NR	0029
HIOSEN	ETII SA / ETIII SA / ETIV SA	4/4,5/5	Regular	R/NR	0030
HIOSEN	ETIII BA	3,5	Mini	R/NR	0029
HIOSEN	ETIII BA	4/4,5/5	Regular	R/NR	0030
HI-TEC	Tapered Self Thread	3,3/3,75	3,5	R/NR	0040
HI-TEC	Tapered Self Thread	4,2/5	4,5	R/NR	0041
HI-TEC	Logic Plus	3,5	3,7	R/NR	0040
HI-TEC	Logic Plus	4,3	3,9	R/NR	0040
IBS	Magic FC	4/4,5/5/5,5/6/6,5	3,8	R/NR	0030
IBS	N.R. Fix	3/3,5	3,8	R/NR	0030
IDO IMPLANTS	I Do Implant	3,8/4/4,5/5/5,5/6/7	Universal	R/NR	0030

## COMPATIBILITIES AVAILABLE

BRAND	MODEL	IMPLANT Ø	PLATFORM	ROTATION	COMPATIBILITY CODE
IHDE DENTAL (IMBIODENT)	Bone Level Plus	3,3	3,3	R/NR	0033
IHDE DENTAL (IMBIODENT)	Bone Level Plus	4,1	4,1	R/NR	0035
IHDE DENTAL (IMBIODENT)	Bone Level Plus	4,8	4,8	R/NR	0035
IMPLANT DIRECT	RePlus / Replant / Reactive	3,5/3,7/4,2	3,5	R/NR	0026
IMPLANT DIRECT	RePlus / Replant / Reactive	4,3/4,7	4,3	R/NR	0027
IMPLANT DIRECT	RePlus / Replant / Reactive	5/5,7	5	R/NR	0028
IMPLANT DIRECT	Legacy	3,7/4,2	3,5	R/NR	0040
IMPLANT DIRECT	Legacy	4,7/5,2	4,5	R/NR	0041
IMPLANT DIRECT	Swishplant / Swishplus	4,1/4,8	4,8	R/NR	0074
IMPLANT DIRECT	Swishplant / Swishplus	4,1/4,8	4,8	R/NR	0037
IMPLANT DIRECT	Swishplant / Swishplus	4,8/5,7	6,5	R/NR	0096
IMPLANT DIRECT	SwishActive	3,3	3	R/NR	0021
IMPLANT DIRECT	SwishActive	4,1/4,8	3,4	R/NR	0022
IMPLANT DIRECT	Interactive	3,2/3,7	3	R/NR	0021
IMPLANT DIRECT	Interactive	4,3/5	3,4	R/NR	0022
IMPLANT DIRECT	Simply Iconic	3,2/3,7/4,2	Purple 3.0	R/NR	0021
IMPLANT DIRECT	Simply Iconic	4,7/5,2/5,7	Gold 3.4	R/NR	0022
IMPLANT GENESIS	Aktiv System	3,5/3,75/4,2/5	Standard	R/NR	0040
IMPLANTSWISS	Bone Level	3,3	3,3	R/NR	0004
IMPLANTSWISS	Bone Level	3,7	3,7	R/NR	0030
IMPLANTSWISS	Bone Level	4,3	4,3	R/NR	0030
IMPLANTSWISS	Bone Level	4,8	4,8	R/NR	0030
IMPLANTSWISS	Bone Level	5,5	5,5	R/NR	0030
IMPLANTSWISS	Multi Unit Abutment	Universal	4,8	R	0025

## COMPATIBILITIES AVAILABLE

BRAND	MODEL	IMPLANT Ø	PLATFORM	ROTATION	COMPATIBILITY CODE
INTRA-LOCK	Unihex	4	Regular	R/NR	0024
INTRA-LOCK	Unihex	4,75	Wide	R/NR	0024
INTRA-LOCK	IntraHex	3,75/4	3,5	R/NR	0040
INTRA-LOCK	IntraHex	4,75	4,5	R/NR	0041
JDENTALCARE	JDEvolution/JDEvolution Plus	3,7	3,7	R/NR	0040
JDENTALCARE	JDEvolution/JDEvolution Plus	4,3/5	4	R/NR	0040
JDENTALCARE	JDEvolution/JDEvolution Plus	6	5	R/NR	0040
JDENTALCARE	JD Pterygo	4	4	R/NR	0040
JDENTALCARE	JD ICON	3,9	3,9	R/NR	0022
JDENTALCARE	JD ICON	4,3	4	R/NR	0022
JDENTALCARE	JD ICON	5	4,7	R/NR	0022
JDENTALCARE	JD ICON Plus	3,7	3,7	R/NR	0015
JDENTALCARE	JD ICON Plus	4,3	4	R/NR	0015
JDENTALCARE	JD ICON Plus	5	4,8	R/NR	0015
JDENTALCARE	JD ICON Plus T	3,5	3,5	R/NR	0015
JDENTALCARE	JD ICON Plus T	4	3,5	R/NR	0015
JDENTALCARE	JD ICON Plus T	4,5	3,5	R/NR	0015
JDENTALCARE	Conical Abutment		Universal	R	0025
KEystone	Restore	3,75/4	RD 4,1	R/NR	0024
KEystone	Internal TiLobe PrimaConnex	3,3/3,5	3,5	R/NR	0044
KEystone	Internal TiLobe PrimaConnex	4/4,1	4,1	R/NR	0045
KEystone	Internal TiLobe PrimaConnex	5	5	R/NR	0046
KEystone	Internal TiLobe Prima Plus	3,5	3,5	R/NR	0044
KEystone	Internal TiLobe Prima Plus	4,1	4,1	R/NR	0045

## COMPATIBILITIES AVAILABLE

BRAND	MODEL	IMPLANT Ø	PLATFORM	ROTATION	COMPATIBILITY CODE
KEYSTONE	Internal TiLobe Prima Plus	5/6	5	R/NR	0046
KLOCKNER	Essential Cone	3,5/4/4,5	4,5	R/NR	0054
KLOCKNER	KL	3,3	Narrow	R/NR	0023
KLOCKNER	KL	3,7/4,2	Regular	R/NR	0024
KLOCKNER	KL	4,7	Wide	R/NR	0061
KLOCKNER	Vega	3,5	NV	R/NR	0082
KLOCKNER	Vega	4/4,5	RV	R/NR	0083
KLOCKNER	Vega+	3,6	NV	R/NR	0082
KLOCKNER	Vega+	4,1/4,6	RV	R/NR	0083
KLOCKNER	Multi Unit Permanent	4,2	Universal	R	0173
LASAK	Bioniq	2,9	QN (Amarillo)	R/NR	0166
LASAK	Bioniq	3,5	QR (Azul)	R/NR	0167
LASAK	Bioniq	4	QR (Azul)	R/NR	0167
LASAK	Bioniq	5	QR (Azul)	R/NR	0167
LEADER	Tixos Internal Hex	3,3	3,5	R/NR	0040
LEADER	Tixos Internal Hex	3,75	4	R/NR	0040
LEADER	Tixos External Hex	3,3/3,75	4,1	R/NR	0024
LEADER	Tixos External Hex	5	5	R/NR	0058
MEDENTIKA	Multi Unit		Universal	R	0025
MEDENTIS	Premium/Active Master	3,3	3,3 (Pink)	R/NR	0249
MEDENTIS	Premium/Active Master	3,75	3,75 (Red)	R/NR	0125
MEDENTIS	Premium/Active Master	4,1	4,1 (Green)	R/NR	0125
MEDENTIS	Premium/Active Master	4,8	4,8 (Blue)	R/NR	0125
MEGAGEN	AnyRidge	3,5	Small	R/NR	0015

## COMPATIBILITIES AVAILABLE

BRAND	MODEL	IMPLANT Ø	PLATFORM	ROTATION	COMPATIBILITY CODE
MEGAGEN	AnyRidge	4/4,5	Regular	R/NR	0015
MEGAGEN	AnyRidge	5/5,5	Wide	R/NR	0015
MEGAGEN	AnyOne Internal	3,5/4/4,5/5/6/7	General	R/NR	0030
MEGAGEN	AnyOne External	3,5	Small 3,5	R/NR	0023
MEGAGEN	AnyOne External	4	Regular 4,1	R/NR	0024
MEGAGEN	AnyOne External	4,5	Regular 4,5	R/NR	0024
MEGAGEN	AnyOne External	5	Wide 5	R/NR	0058
MEGAGEN	AnyOne External	6	SuperWide 5,5	R/NR	0058
MEGAGEN	Cone Abutment	Universal	4,8	R/NR	0074
MEGAGEN	Mini Narrow Ridge	3/3,4	Mini	R/NR	0014
MEGAGEN	ExFeel	3,5	Small	R/NR	0037
MEGAGEN	ExFeel	4,1	Regular	R/NR	0037
MEGAGEN	ExFeel	4,8/5	Wide	R/NR	0037
MEGAGEN	Cone Abutment	Universal	3,8	R	0128
MEGAGEN	Multi Unit N Type	Multi Unit N Type	Universal	R	0025
MICRODENT	Universal	2,8/3,25	3,5	R/NR	0003
MICRODENT	Universal	3,3/3,5/3,75/4	4,1	R/NR	0024
MICRODENT	Universal	4,2/5	5,1	R/NR	0058
MICRODENT	System	2,8/3,25	3,5	R/NR	0003
MICRODENT	Ektos	3,7/4,2	3,5	R/NR	0040
MIS	Lance	3,75/4,2	Standard	R/NR	0024
MIS	Lance	5	Wide	R/NR	0058
MIS	Seven	3,3	Narrow	R/NR	0019
MIS	Seven	3,75/4,2	Standard	R/NR	0040

## COMPATIBILITIES AVAILABLE

BRAND	MODEL	IMPLANT Ø	PLATFORM	ROTATION	COMPATIBILITY CODE
MIS	Seven	5/6	Wide	R/NR	0041
MIS	M4	3,3	Narrow	R/NR	0019
MIS	M4	3,75/4,2	Standard	R/NR	0040
MIS	M4	5/6	Wide	R/NR	0041
MIS	C1	3,3	Narrow	R/NR	0016
MIS	C1	3,75/4,2	Standard	R/NR	0017
MIS	C1	5	Wide	R/NR	0018
MIS	V3	3,9/4,3/5	Standard	R/NR	0017
MIS	Multi-Unit		General	R	0020
MOZO-GRAU (TICARE)	MG Osseous	3,3	3,4 Mini	R/NR	0003
MOZO-GRAU (TICARE)	MG Osseous	3,4/3,75/4,25	4,1 Standard	R/NR	0024
MOZO-GRAU (TICARE)	MG Osseous	5	5 Maxi	R/NR	0061
MOZO-GRAU (TICARE)	MG Inhex	3,3	2,3 Mini	R/NR	0109
MOZO-GRAU (TICARE)	MG Inhex	3,75/4,25	2,8 Standard	R/NR	0004
MOZO-GRAU (TICARE)	MG Inhex	5	3,8 Maxi	R/NR	0005
MPI	Conexión Externa HE Privilege	3,3	3,5	R/NR	0009
MPI	Conexión Externa HE Privilege	3,3/4	4,1	R/NR	0024
MPI	Conexión Externa HE Privilege	5	5	R/NR	0058
MPI	Privilege CM	3,5/4	Regular	R/NR	0004
MPI	Privilege CM	5	Wide	R/NR	0005
MPI	Excellence CM	3,5/4	Regular	R/NR	0004
MPI	Excellence CM	5	Wide	R/NR	0005
NEOBIOTECH	EB External System	3,5	Narrow	R/NR	0023
NEOBIOTECH	IS Implant System	3,2	S-Narrow	R/NR	0029

## COMPATIBILITIES AVAILABLE

BRAND	MODEL	IMPLANT Ø	PLATFORM	ROTATION	COMPATIBILITY CODE
NEOBIOTECH	IS Implant System	3,5	Narrow	R/NR	0030
NEOBIOTECH	IS Implant System	4	Regular	R/NR	0030
NEOBIOTECH	IS Implant System	4,5	Regular	R/NR	0030
NEOBIOTECH	IS Implant System	5	Wide	R/NR	0030
NEOBIOTECH	IS Implant System		4,8	R	0025
NEODENT	Helix GM/Drive GM/Titamax GM	3,5/3,75/4/4,3/5/6	Regular	R/NR	0186
NEODENT	Smart HE	3,75/4	4,1	R/NR	0024
NEODENT	Mini Pilar CM / Mini Pilar Angulado CM	Mini Pilar CM / Mini Pilar Angulado CM	Universal	R	0025
NEOSS	ProActive Straight/Tapered/Edge	3,5 Green	Standard	R/NR	0047
NEOSS	ProActive Straight/Tapered/Edge	4 Yellow	Standard	R/NR	0047
NEOSS	ProActive Straight/Tapered/Edge	4,5 Blue	Standard	R/NR	0048
NEOSS	ProActive Straight/Tapered/Edge	5 Peach	Standard	R/NR	0048
NEOSS	ProActive Straight/Tapered/Edge	5,5 Lilac	Standard	R/NR	0048
NEOSS	ProActive Wide	6	Standard	R/NR	0048
NEOSS	ProActive Sinus	6,5	Standard	R/NR	0048
NEOSS	Short Implant	3,5/4/4,5	Standard	R/NR	0047
NEOSS	Short Implant	5/5,5/6/6,5	Standard	R/NR	0048
NOBEL BIOCARE	Branemark	3,3	Narrow	R/NR	0023
NOBEL BIOCARE	Branemark	3,75/4	Regular	R/NR	0024
NOBEL BIOCARE	Branemark	5/6	Wide	R/NR	0061
NOBEL BIOCARE	Replace	3,5	Narrow	R/NR	0026
NOBEL BIOCARE	Replace	4,3	Regular	R/NR	0027
NOBEL BIOCARE	Replace	5	Wide	R/NR	0028
NOBEL BIOCARE	Replace	6	Platform 6	R/NR	0129

## COMPATIBILITIES AVAILABLE

BRAND	MODEL	IMPLANT Ø	PLATFORM	ROTATION	COMPATIBILITY CODE
NOBEL BIOCARE	Active/Replace Conical Connection	3	Mini 3.0	R/NR	0159
NOBEL BIOCARE	Active/Replace Conical Connection	3,5	Narrow	R/NR	0021
NOBEL BIOCARE	Active/Replace Conical Connection	4,3/5	Regular	R/NR	0022
NOBEL BIOCARE	Active/Replace Conical Connection	5,5	Wide	R/NR	0124
NOBEL BIOCARE	NobelSpeedy	3,3	Narrow	R/NR	0023
NOBEL BIOCARE	NobelSpeedy	4/5	Regular	R/NR	0024
NOBEL BIOCARE	NobelSpeedy	5/6	Wide	R/NR	0061
NOBEL BIOCARE	NobelParallel	3,75	Narrow	R/NR	0021
NOBEL BIOCARE	NobelParallel	4,3/5	Regular	R/NR	0022
NOBEL BIOCARE	NobelParallel	5,5	Wide	R/NR	0124
NOBEL BIOCARE	Multi-Unit	Regular	Regular	R	0025
NORIS MEDICAL	Tuff	3,3/3,75/4,2/5/6	3,75	R/NR	0040
NORIS MEDICAL	Tuff TT	3,3/3,75/4,2/5/6	3,75	R/NR	0040
NORIS MEDICAL	Onix	3,3/3,75/4,2/5/6	3,75	R/NR	0040
NORIS MEDICAL	Cortical	4,0/5/6	3,75	R/NR	0040
NORIS MEDICAL	PteryCore	4,2	3,75	R/NR	0040
NORIS MEDICAL	PteryFit	4,2	3,75	R/NR	0040
NORMON	Normoimplant HE	3,25/3,75/4,25/4,75	4,1	R/NR	0024
NORMON	Normoimplant HI	3,75/4,25/4,75	3,5	R/NR	0040
NOVA IMPLANTS	PSI/PCI	3,3/3,75/4,2/5/6	3,75	R/NR	0040
OSSTEM IMPLANT	TS	3,5	Mini 3,5	R/NR	0029
OSSTEM IMPLANT	TS	4/4,5/5/6/7	Regular	R/NR	0030
OSSTEM IMPLANT	US	3,3/3,5	Mini 3,5	R/NR	0023
OSSTEM IMPLANT	US	3,75/4/4,5	Regular 4,1	R/NR	0024

## COMPATIBILITIES AVAILABLE

BRAND	MODEL	IMPLANT Ø	PLATFORM	ROTATION	COMPATIBILITY CODE
OSSTEM IMPLANT	US	5/5,5	Wide 5,1	R/NR	0061
OSSTEM IMPLANT	US	5/5,5	Wide PS 5	R/NR	0058
OSTEOPLUS	She	3,45	3,45	R/NR	0009
OSTEOPLUS	She	3,75 / 4	4	R/NR	0024
OSTEOPLUS	Shi	3,3 / 3,75 / 4,2	3,5	R/NR	0040
OXY	K1 Line	3,5/4/4,5/5	Regular	R/NR	0015
OXY	K1 Line	5,5/6/6,5	Wide	R/NR	0015
OXY	PSK Line	3,5/4/4,5/5	Regular	R/NR	0015
OXY	MD Line KONE	3,75/4.25/5	Regular	R/NR	0015
OXY	MD Line Ext	3,75/4,25	Standard	R/NR	0024
PALTOP	Advanced classic	3,25	Narrow (blue)	R/NR	0229
PALTOP	Advanced classic	6	Wide (purple)	R/NR	0041
PALTOP	Advanced +	3,25	Narrow (blue)	R/NR	0229
PALTOP	Advanced +	6	Wide (purple)	R/NR	0041
PALTOP	Dynamic	3,25	Narrow (blue)	R/NR	0229
PALTOP	Dynamic	6	Wide (purple)	R/NR	0041
PALTOP	Conical Active	3,25/3,75/4,2/5	Standard	R/NR	0029
PALTOP	Advanced classic	3,75/4,2/5	Standard	ZIO	0042
PALTOP	Advanced +	3,75/4,2/5	Standard	ZIO	0042
PALTOP	Dynamic	3,75/4,2/5	Standard	ZIO	0042
PALTOP	DIVA/ACTIVE	3,75/4,2/5	Standard	ZIO	0042
PALTOP	Advanced classic	3,75/4,2/5	Standard	R	0040
PALTOP	Advanced +	3,75/4,2/5	Standard	R	0040
PALTOP	Dynamic	3,75/4,2/5	Standard	R	0040

## COMPATIBILITIES AVAILABLE

BRAND	MODEL	IMPLANT Ø	PLATFORM	ROTATION	COMPATIBILITY CODE
PALTOP	DIVA/ACTIVE	3,75/4,2/5	Standard	R	0040
PALTOP	Universal Multi-Unit	Multi-Unit	Universal	R	0181
PHIBO	TSH/BNT Serie 3	3,6	4	R/NR	0024
PHIBO	TSH/BNT Serie 4	4,2	4	R/NR	0024
PROCLINIC	Cilindrico Externo/Cónico Externo	3,75/4,25//3,5/4	4,1 Estandar	R/NR	0024
PROCLINIC	Cilindrico Externo/Cónico Externo	5	5 Maxi	R/NR	0058
PROCLINIC	Cilindrico Interno/Cónico Interno	3,3/3,75/4,25/5//3,5/4/5	3,5	R/NR	0040
PROCLINIC	SP Octa	3,3/4,1/4,8	4,8	R/NR	0074
PROCLINIC	SP Octa	3,3/4,1/4,8	4,8	R/NR	0037
PROCLINIC	SP Octa	4,8	6,5	R/NR	0096
PROCLINIC	Aqua CM	3,5/4/5	2,82	R/NR	0004
RADHEX	PHE	3,5	3,5	R/NR	0023
RADHEX	PHE	4/4,5/5	4,1	R/NR	0024
RADHEX	PHI	3,75	3,5	R/NR	0040
RADHEX	PHI	4,5/5	4,5	R/NR	0041
REFLECT	Rapid	3,0	3,0	R/NR	0159
REFLECT	Rapid	3,5	NP	R/NR	0021
REFLECT	Rapid	4,3/5/5,5	RP	R/NR	0022
REFLECT	Recover	3,5	NP	R/NR	0021
REFLECT	Recover	4,3/5	RP	R/NR	0022
REFLECT	Aspire	3,5/4	Aqua(Estrecha)	R/NR	0004
REFLECT	Aspire	5	Lilac (Ancha)	R/NR	0005
REFLECT	Tapered Screw	3,5	3,5	R/NR	0040
REFLECT	Tapered Screw	4,1/4,7	4,5	R/NR	0041

## COMPATIBILITIES AVAILABLE

BRAND	MODEL	IMPLANT Ø	PLATFORM	ROTATION	COMPATIBILITY CODE
SEWON MEDIX	IH2 SLA SYSTEM	3,5	Mini	R/NR	0029
SEWON MEDIX	IH2 SLA SYSTEM	3,5/4/4,5/5	Regular	R/NR	0030
SEWON MEDIX	IH2 RBM SYSTEM	3,5	Mini	R/NR	0029
SEWON MEDIX	IH2 RBM SYSTEM	3,5/4/4,5/5	Regular	R/NR	0030
SEWON MEDIX	IH SYSTEM	3,5/4/4,5/5	Universal	R	0025
SIC INVENT	HEXAGONAL SYSTEM SICace	3,4/4	3,3	R/NR	0170
SIC INVENT	HEXAGONAL SYSTEM SICace	4,5/5	4,2	R/NR	0171
SIC INVENT	HEXAGONAL SYSTEM SICMax	3,4/4,2	3,3	R/NR	0170
SIC INVENT	HEXAGONAL SYSTEM SICMax	4,7/5,2	4,2	R/NR	0171
SIC INVENT	HEXAGONAL SYSTEM SICtapered	3,4/4,2	3,3	R/NR	0170
SIC INVENT	HEXAGONAL SYSTEM SICtapered	4,7/5,2	4,2	R/NR	0171
SIGNO VINCES	Duo	4,6	4,1	R/NR	0024
SIGNO VINCES	Inttegra	3,75/4	4,1	R/NR	0024
SIGNO VINCES	Compact	4,5	CM3,8	R/NR	0004
SIGNO VINCES	Duocon	3,8	CM3,8	R/NR	0004
SIGNO VINCES	Duocon	4,6/5,5	CM4,6	R/NR	0005
SIGNO VINCES	Infra	3,3/3,8/4,6	CM	R/NR	0004
SIN IMPLANTS	HI SW	3,8	3,8	R/NR	0039
SIN IMPLANTS	Tryon	3,25/3,75/4	4,1	R/NR	0024
SIN IMPLANTS	Tryon CO	4	4,1	R/NR	0024
SIN IMPLANTS	Revolution	3,25/3,75/4	4,1	R/NR	0024
SIN IMPLANTS	Stylus	4	4,1	R/NR	0024
SOUTHERN IMPLANTS	Tri-Nex	3,5	3,5	R/NR	0026
SOUTHERN IMPLANTS	Tri-Nex	4,3	4,3	R/NR	0027

## COMPATIBILITIES AVAILABLE

BRAND	MODEL	IMPLANT Ø	PLATFORM	ROTATION	COMPATIBILITY CODE
SOUTHERN IMPLANTS	Tri-Nex	5	5	R/NR	0028
SOUTHERN IMPLANTS	Tri-Nex	6	6	R/NR	0129
SOUTHERN IMPLANTS	IT Connection	3,3/4/4,1/4,9/5	4,8	R/NR	0037
SOUTHERN IMPLANTS	IT Connection	4,9/5/6	6,5	R/NR	0096
SOUTHERN IMPLANTS	External Hex	3,25	3,4	R/NR	0003
SOUTHERN IMPLANTS	External Hex	3,75/4	4,1	R/NR	0024
SOUTHERN IMPLANTS	External Hex	4,7/5	5	R/NR	0058
SOUTHERN IMPLANTS	External Hex	5,7/6	6	R/NR	0058
SOUTHERN IMPLANTS	Deep Conical	3	2,45	R/NR	0109
SOUTHERN IMPLANTS	Deep Conical	3,5/4	2,95/3,1	R/NR	0004
SOUTHERN IMPLANTS	Deep Conical	5	4,1	R/NR	0005
SOUTHERN IMPLANTS	Internal Hex	3,75/4,2/5	Universal	R/NR	0040
SOUTHERN IMPLANTS	Provata	4/5/6	Standard	R/NR	0040
SOUTHERN IMPLANTS	Compact Conical	4,8	4,8	R	0025
STERI-OSS	Hex-Loc	3,25	3,3	R/NR	0023
STERNGOLD	STERN EX	3,75/4/5	4,1	R/NR	0024
STRAUMANN	Tissue Level	3,3	3,5	R/NR	0160
STRAUMANN	Tissue Level	3,3/4,1/4,8	Regular 4,8	R/NR	0037
STRAUMANN	Tissue Level	4,8	Wide 6,5	R/NR	0096
STRAUMANN	Synocta		Regular 4,8	R/NR	0074
STRAUMANN	Synocta		Wide 6,5	R/NR	0137
STRAUMANN	Bone Level Tapered SC	2,9	SC- 2,9	R/NR	0135
STRAUMANN	Bone Level	3,3	NC- 3,3	R/NR	0033
STRAUMANN	Bone Level	4,1	RC-4,1	R/NR	0035

## COMPATIBILITIES AVAILABLE

BRAND	MODEL	IMPLANT Ø	PLATFORM	ROTATION	COMPATIBILITY CODE
STRAUMANN	Bone Level	4,8	RC-4,8	R/NR	0035
STRAUMANN	BLX	3,5/3,75/4/4,5	RB (Regular Base)	R/NR	0207
STRAUMANN	BLX	5/5,5/6,5	WB (Wide Base)	R/NR	0208
STRAUMANN	TLX / TLX S	3,75/4,5	NT	R/NR	0260
STRAUMANN	TLX / TLX S	3,75/4,5	RT	R/NR	0261
STRAUMANN	TLX / TLX S	5,5/6,5	WT	R/NR	0262
STRAUMANN	Screw-Retained	NC/RC 04,6	Universal	R	0101
SYBRON IMPLANT SOLUTIONS	Endopore (Innova)	4,1	4,1	R/NR	0024
TBR	Hex-Conic	5	Wide	R/NR	0058
TBR	Connect / Infinity	3,5	3,5	R/NR	0266
TBR	Connect / Infinity	4	4	R/NR	0267
TBR	Connect / Infinity	5	5	R/NR	0268
TITANIUM-FIX	b-fix	3,5/4	Regular	R/NR	0004
TITANIUM-FIX	b-fix	4,5/5	Larga	R/NR	0005
TREE-OSS	Simple	3,3/3,75/5	3,75 Amarillo	R/NR	0040
TREE-OSS	Rapid/Anatomic	3,3	3,5 Rosa	R/NR	0023
TREE-OSS	Rapid/Anatomic	3,75/4	4,1 Amarillo	R/NR	0024
TREE-OSS	Rapid/Anatomic	5	5,1 Azul	R/NR	0061
TREE-OSS	Anatomic/HS	3,5	3,5 Rosa	R/NR	0026
TREE-OSS	Anatomic/HS	4,3	4,3 Amarillo	R/NR	0027
TREE-OSS	Anatomic/HS	5	5 Azul	R/NR	0028
TREE-OSS	Multi Unit		Universal	R	0025
TRI DENTAL IMPLANTS	TRI-Vent	3,75/4,1/4,7	3,5	ZIO	0042
TRI DENTAL IMPLANTS	TRI-Vent	3,75/4,1/4,7	3,5	R	0040

## COMPATIBILITIES AVAILABLE

BRAND	MODEL	IMPLANT Ø	PLATFORM	ROTATION	COMPATIBILITY CODE
TRINON	QZ	3,5/3,75/4,5	4	R/NR	0024
TRINON	QK	4	4,8	R/NR	0074
TRINON	QK	4	4,8	R/NR	0037
UFIT	Gt2	3,5	Mini	R/NR	0004
UFIT	Gt2	4/4,5	Regular	R/NR	0005
UFIT	Gt2	5	Wide	R/NR	0005
UFIT	Gt2	5,5/6/6,5/7	Ultra-wide	R/NR	0005
UFIT	Nt2	3,5	Mini	R/NR	0004
UFIT	Nt2	4/4,5	Regular	R/NR	0005
UFIT	Nt2	5	Wide	R/NR	0005
UFIT	Nt2	5,5/6/6,5/7	Ultra-wide	R/NR	0005
VULKAN IMPLANTS	IN-Hex	3,3/3,75/4,2/5	3,75	R/NR	0040
WIN	WIN	3,30/3,75/4,25/5	3,75	R/NR	0040
WIN	WIN	Universal	Universal	R	0025
XIVE	Xive	3	3	R/NR	0084
XIVE	Xive	3,4	3,4	R/NR	0038
XIVE	Xive	3,8	3,8	R/NR	0039
XIVE	Xive	4,5	4,5	R/NR	0085
XIVE	Xive	5,5	5,5	R/NR	0086
YES IMPLANT	S-SYSTEM	3,3/3,5	Narrow	R/NR	0030
YES IMPLANT	S-SYSTEM	4/4,5	Regular	R/NR	0030
YES IMPLANT	S-SYSTEM	5/5,5	Wide	R/NR	0030
ZIACOM	OEX	3,75/4,25	RP 4,1	R/NR	0024
ZIMMER	Screw-Vent	3,7/4,1	3,5	R/NR	0040

## COMPATIBILITIES AVAILABLE

BRAND	MODEL	IMPLANT Ø	PLATFORM	ROTATION	COMPATIBILITY CODE
ZIMMER	Screw-Vent	6	5,7	R/NR	0080
ZIMMER	TSX Implant	3,1	2,9	R/NR	0178
ZIMMER	TSX Implant	3,7/4,1/4,7	3,5	R/NR	0040
ZIMMER	TSX Implant	5,4/6	4,5	R/NR	0041
ZIMMER	Swiss-Plus	3,7/4,1/4,8	4,8	R/NR	0074
ZIMMER	Swiss-Plus	3,7/4,1/4,8	4,8	R/NR	0037
ZIMMER	Eztetic	3,1	2,9	R/NR	0178
ZIMMER	Screw-Vent	3,7/4,1	3,5	ZIO	0042
ZIMMER	Screw-Vent	4,7	4,5	ZIO	0043
ZIMMER	TSX Implant	3,7/4,1/4,7	3,5	ZIO	0042
ZIMMER	TSX Implant	5,4/6	4,5	ZIO	0043
ZIMMER	Tapered Abutment	Universal	Universal	R	0205



DYNAMIC ABUTMENT® SOLUTIONS

# MULTI-UNIT DAS SYSTEM

Work different, work better

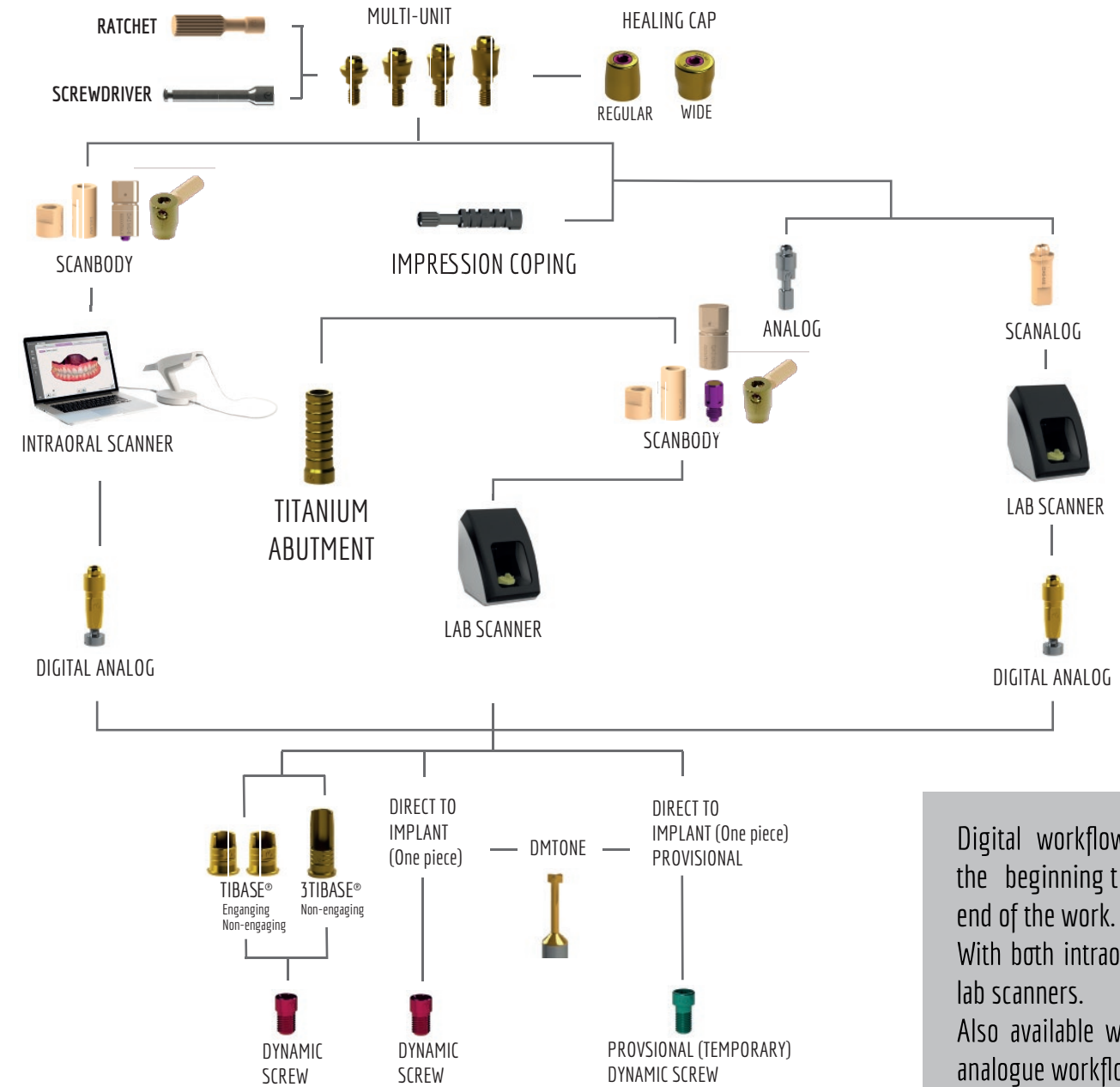

Digital workflow from the beginning to the end of the work. With both intraoral and lab scanners. Also available with full analogue workflow.

# CAD-CAM MULTI-UNIT WORKFLOW



# MULTI-UNIT

The Multi-unit abutment has been carefully designed to rehabilitate partially or fully edentulous arches, as well as individual.

Maximum diameter of the MU is 4mm, being narrower it avoids contact with the bone

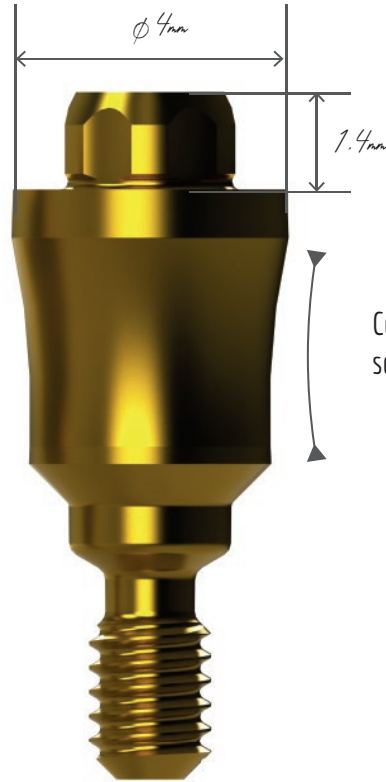

Lower cone height which allows greater disparallelism than the classic multi-unit.

Divergence between implants: 50°

Concave design facilitates healing and soft tissue adaptation.

Available in different gingival heights.

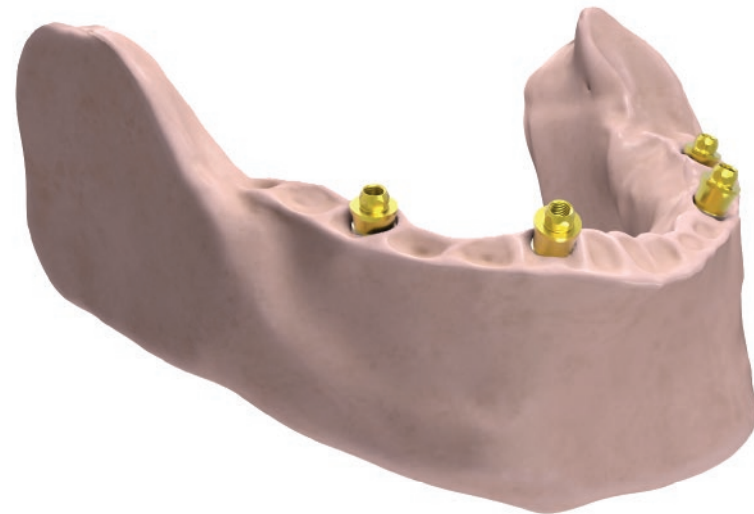
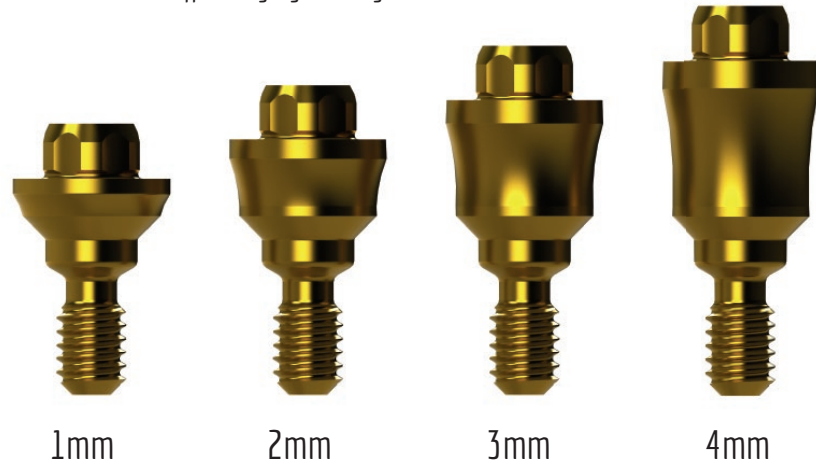

## MU Insertion Procedure

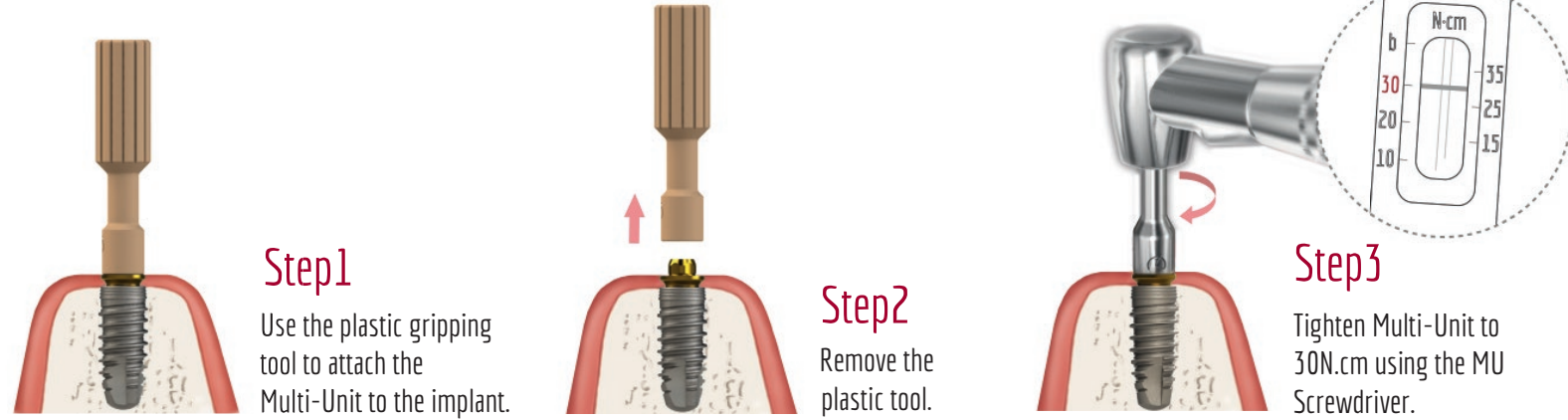

**Step1**

Use the plastic gripping tool to attach the Multi-Unit to the implant.

**Step2**

Remove the plastic tool.

**Step3**

Tighten Multi-Unit to 30N.cm using the MU Screwdriver.

## MU Healing Caps

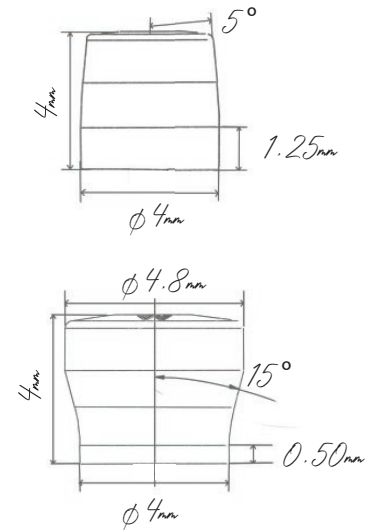
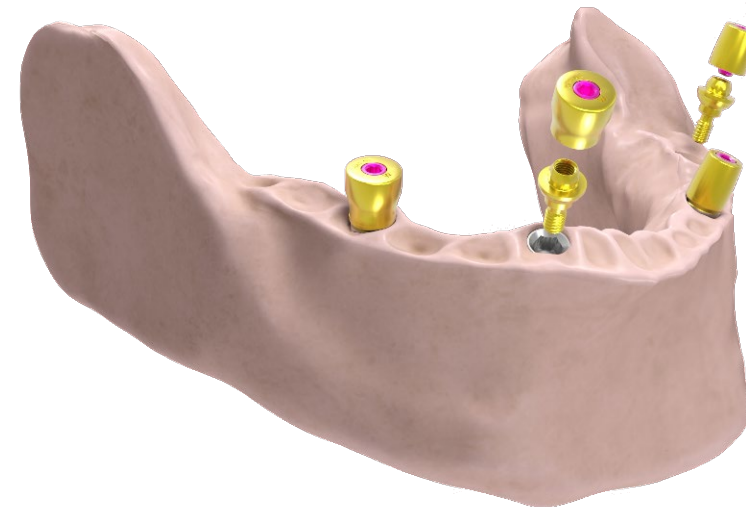

Healing cap Regular



Healing cap Wide

## MULTI-UNIT SCANBODY



3 different scanbodi available in order to choo in which situation is bett to use 4,5mm, 8mm Dynamic  $\mu$ Scanbody wi magnet system.

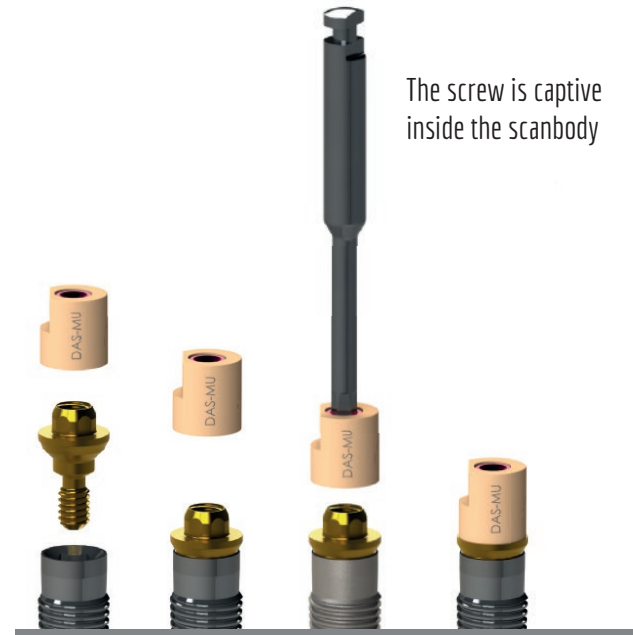
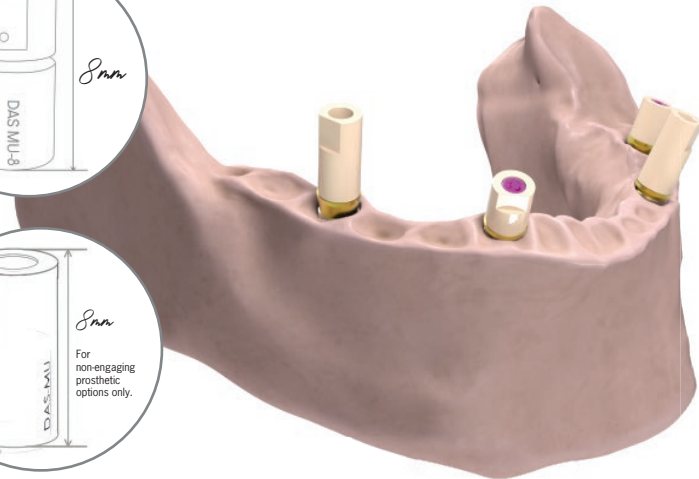

## DIGITAL ANALOG

Digital analog of the dental implant to simulate implant position in a 3D printed dental model.

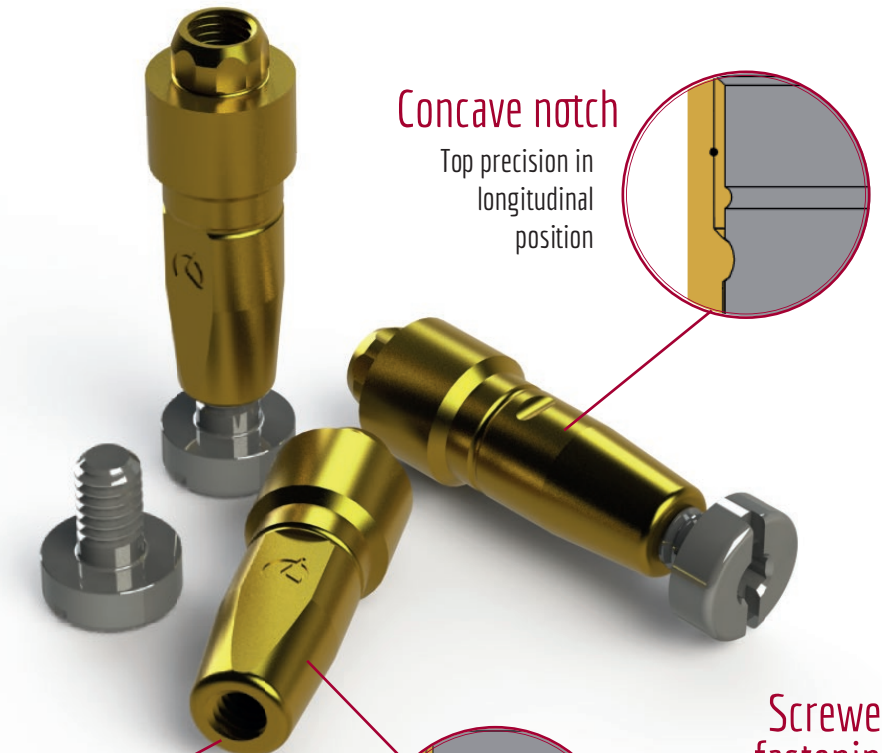

## MULTI-UNIT SCANALOG

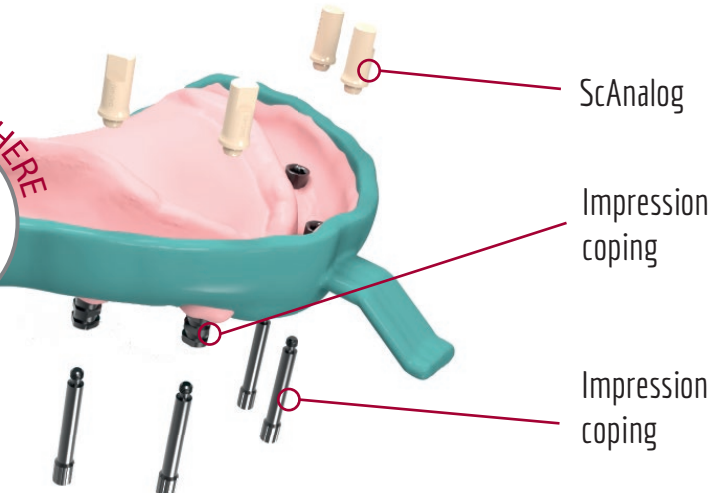

## DYNAMIC $\mu$ SCANBODY

All components of DAS System can also Dynamic  $\mu$ Scanbody implant and select v gingival height Mult

You can scan wit  $\mu$ Scanbody and ther Dynamic  $\mu$ Scanbody MU components.

For non-engaging prosti

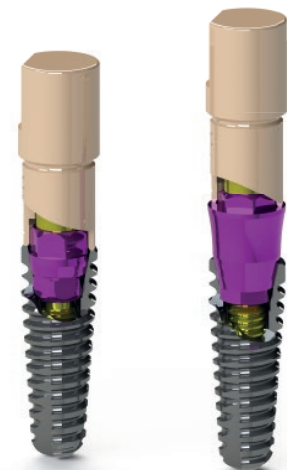

## ANALOG

Also available traditional analog for plaster model.

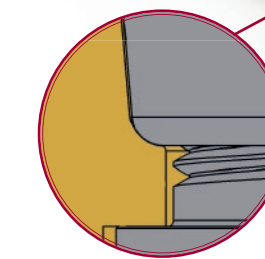

Accuracy of orientation guaranteed

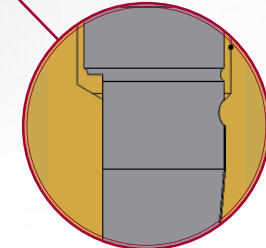

Longitudinal cut to avoid rotation X-Y

Screwed fastening

Prevents the analog from moving in Z

# DYNAMIC TIBASE®

To correct ANGULATION up to 45°

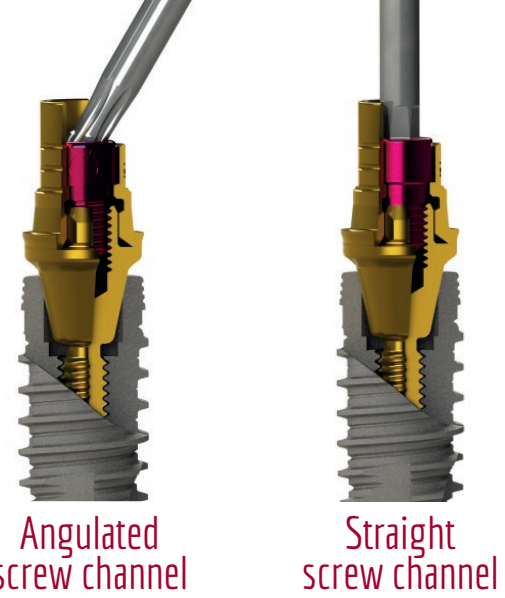

Angulated screw channel  
Straight screw channel



TIBASE® NON-ENGAGING  
TIBASE® ENGAGING  
3TIBASE® NON-ENGAGING

## CAD DESIGN

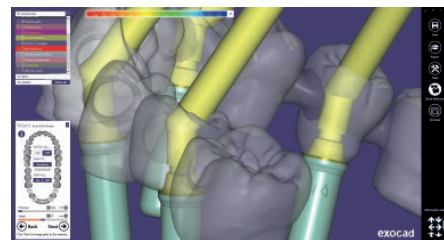

DAS Multi-Unit system allows changes the MU in the library without rescanning or redesigning the case. That facilitates the lab and clinic work, as technician can change the MU without the need to make a new appointment with the patient to re-scan.

If we make a NR case, the option of changing MU is not allow in the design.

## DIRECT TO IMPLANT (One piece)

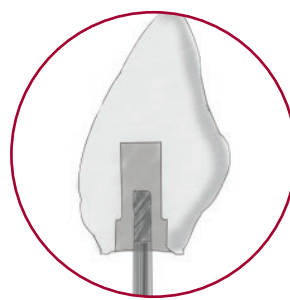

Step 1  
Crown with pre drill



Step 2  
Crown with angled channel

## DMTONE DYNAMIC MILLING TOOL



Final restorations 0-45°

Direct to implant libraries available R/NR

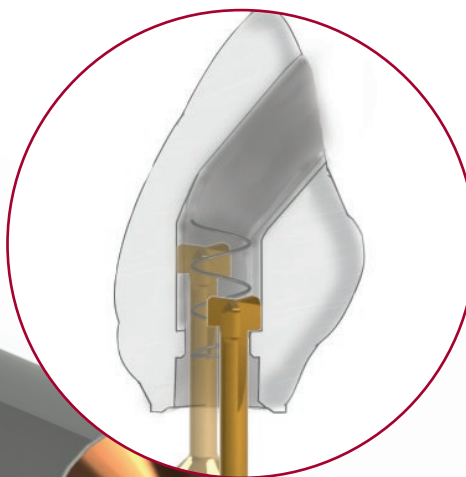

### Step 3 DMTONE

Crown with Dynamic Milling Tool. Milling the screw seat and increasing the diameter of the straight channel.



Dynamic screw

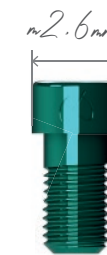

Provisional (temporary) Dynamic screw

Greater seating thickness  
Greater contact surface between the screw and the material for greater safety in soft materials.

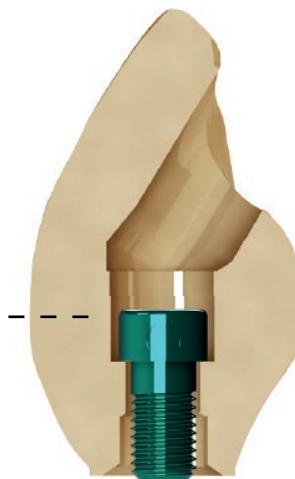

Provisional (temporary) restorations up to 35°

Provisional (temporary) Direct to implant libraries available R/NR

# MILLING OPTIONS

## Rotatory restoration

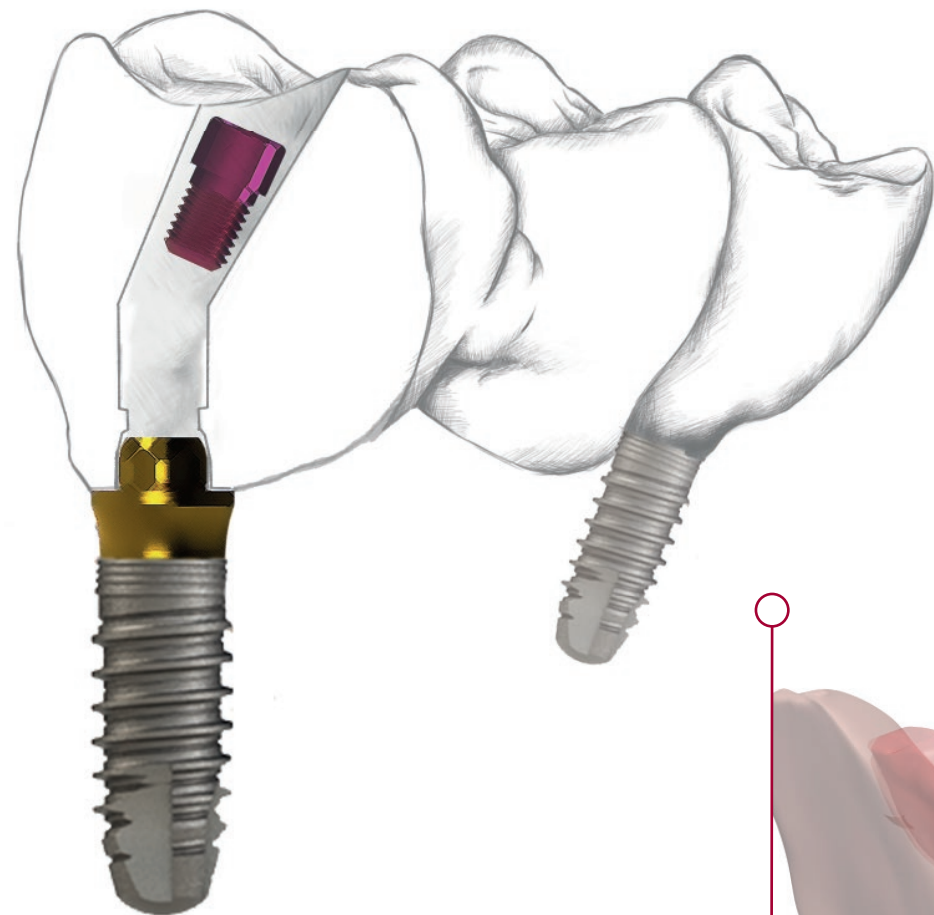

The Multi-Unit DAS System offers you different library options for further support in working with rotary Multi-Unit.

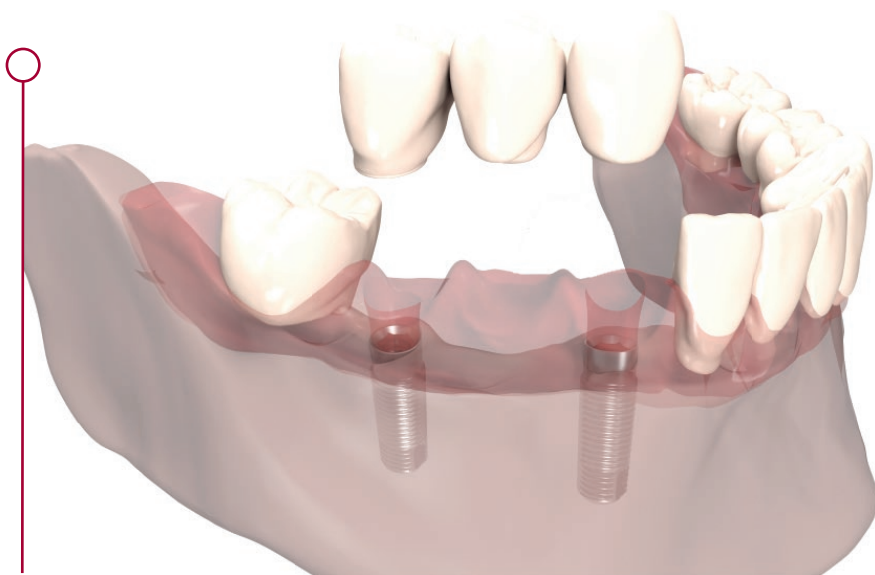

The greater the support surface, the lesser the degree of divergence.

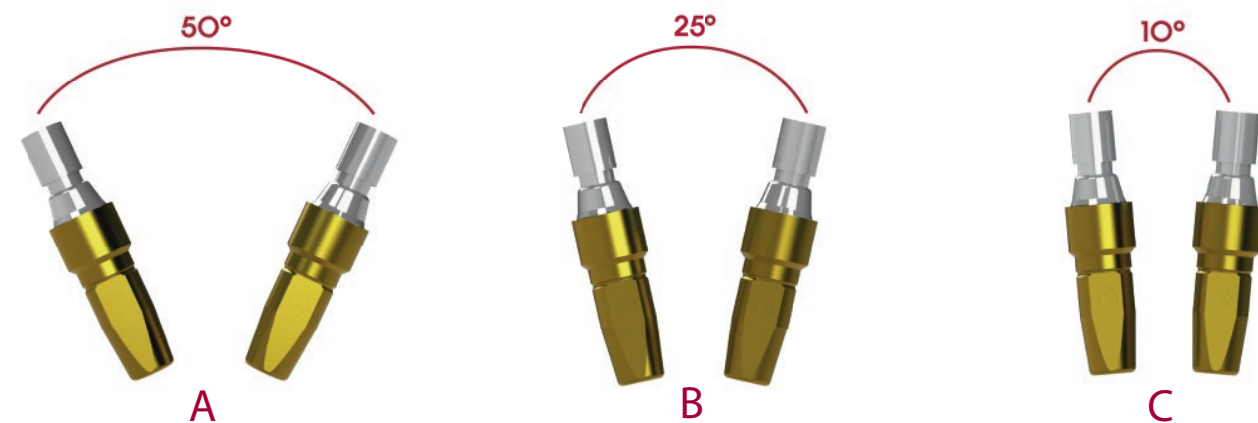
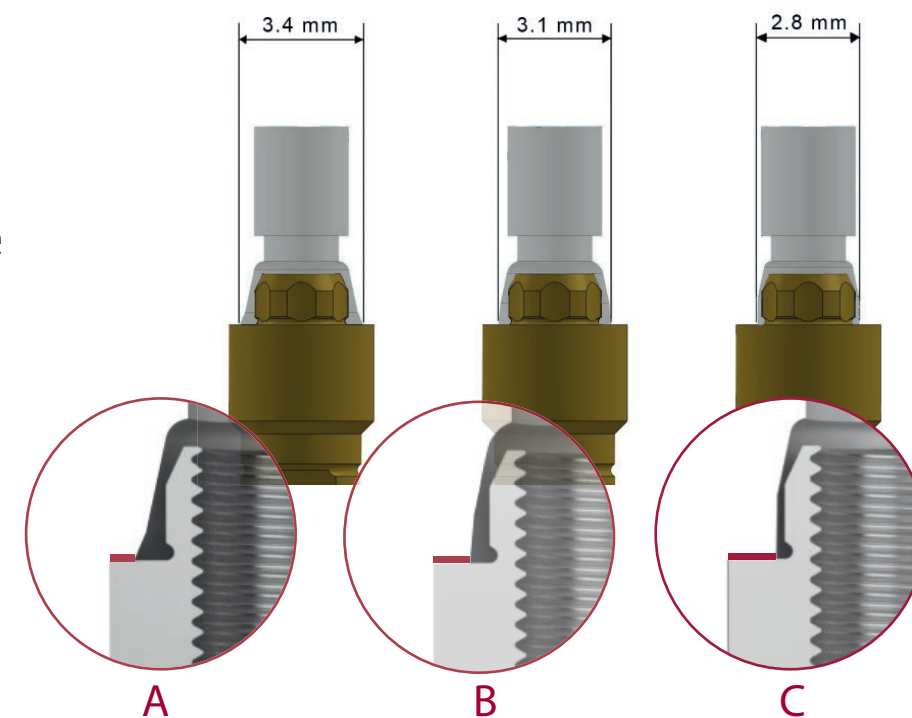

Option A: Default in the DAS library.

Options B and C: contact [das@dynamicabutment.com](mailto:das@dynamicabutment.com)

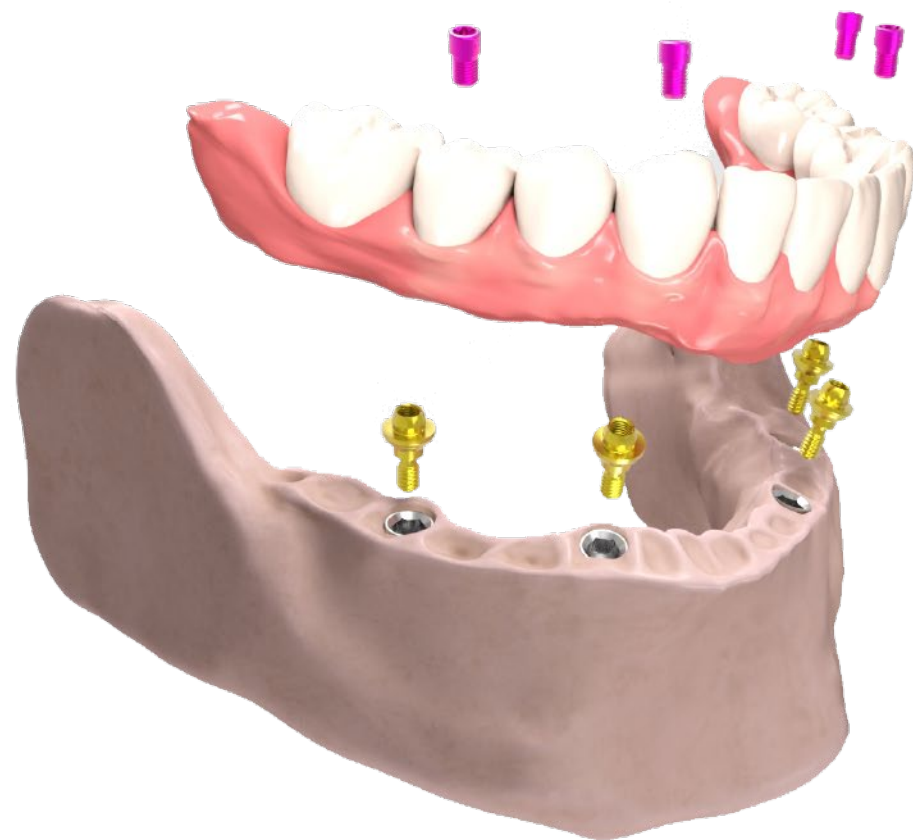

## LIST OF MULTI-UNIT COMPATIBILITIES AVAILABLE

AB	BTK	GMI (ILERIMPLANT)	MICRODENT	SIGNO VINCES
ACE	B&W	GT MEDICAL	MIS	SIN IMPLANTS
ADIN	CAMLOG	HAHN IMPLANT (GLIDEWELL)	MOZO-GRAU (TICARE)	SOUTHERN IMPLANTS
ALFA-GATE	CONEXÃO SISTEMA DE PRÓTESE	HIOSSSEN	MPI	STERNGOLD
ALPHABIO	CORTEX	HI-TEC	NEOBIOTECH	STRAUMANN
ANCLADEN	DENTIS	IBS	NEODENT	SYBRON IMPLANT SOLUTIONS
ANKYLOS	DENTIUM	IDO IMPLANTS	NOBEL BIOCARE	TITANIUM-FIX
ANTHOGYR	DIO IMPLANTS	IHDE DENTAL (IMBIODENT)	NORIS MEDICAL	TREE-OSS
ARDS	DMI DENTAL SUPPLY	IMPLANT DIRECT	NORMON	TRI DENTAL IMPLANTS
ASTRA	DSP BIOMEDICAL	IMPLANT GENESIS	OSSTEM IMPLANT	TRINON
AVINENT	EASY IMPLANT	IMPLANTSWISS	OSTEOPLUS	UFIT
BIOCONCEPT	ECKERMANN	INTRA-LOCK	OXY	VULKAN IMPLANTS
BIOGENESIS	ELITE MEDICA	JDENTALCARE	PALTOP	XIVE
BIOHORIZONS	EUROTEKNIKA	KEYSTONE	PHIBO	YES IMPLANT
BIOMET 3i	F&B IMPLANT (FIT & BRILLIANT)	KLOCKNER	PROCLINIC	ZIACOM
BIONER	GALIMPLANT	LEADER	RADHEX	ZIMMER
BIOTEC	GLOBAL D (TEKKA)	MEDENTIS	REFLECT	
BTI		MEGAGEN	SEWON MEDIX	

## COMPATIBILITIES AVAILABLE

BRAND	MODEL	IMPLANT Ø	PLATFORM	ROTATION	COMPATIBILITY CODE
AB	I2	3,5/3,75/4,2/4,5/	Standard	R	0040
AB	I2	5/6	Standard	R	0040
AB	I22	3,75/4,22	Standard	R	0040
AB	I5	3,5/3,75/4,2/4,5/	Standard	R	0040
AB	I5	5/6/7/8	Standard	R	0040
AB	I55	3,75/4,2/4,5	Standard	R	0040
AB	I55	5/6/7/8	Standard	R	0040
AB	I10	4,2/5	Standard	R	0040
AB	I15	6/7/8	Standard	R	0040
ACE	External Hex	3,75/4	RP 4,1	R	0024
ACE	Infinity Internal Hex	3,7/4,1	3,5	R	0040
ADIN	Swell	3,3	3,45	R	0040
ADIN	Swell	3,75/4,2	3,6	R	0040
ADIN	Swell	5	4	R	0040
ADIN	Swell	6	4,6	R	0040
ADIN	Touareg-S / Touareg-OS	3,5	3,45	R	0040
ADIN	Touareg-S / Touareg-OS	3,75/4,2	3,6	R	0040
ADIN	Touareg-S / Touareg-OS	5	4	R	0040
ADIN	Touareg-S / Touareg-OS	6	5	R	0040
ADIN	Touareg CloseFit	3,5	RP	R	0021
ADIN	Touareg CloseFit	4,3/5	WP	R	0022
ALFA-GATE	Bioactive S-line/SLA	3,3/3,75/4,2/4,7/5,2/6	3,75	R	0040
ALFA-GATE	Conical	3,5	NP	R	0021
ALFA-GATE	Conical	4,3/5	RP	R	0022

## COMPATIBILITIES AVAILABLE

BRAND	MODEL	IMPLANT Ø	PLATFORM	ROTATION	COMPATIBILITY CODE
ALPHABIO	Internal Hex Connection (IH) SPI	3,3/3,75/4,2/5/6	Universal	R	0040
ALPHABIO	Internal Hex Connection (IH) ICE	3,7/3,75/4,2/4,65/5,3	Universal	R	0040
ALPHABIO	Internal Hex Connection (IH) DFI	3,3/3,75/4,2/5	Universal	R	0040
ALPHABIO	Internal Hex Connection (IH) ATID	3,3/3,75/4,2/5/6	Universal	R	0040
ALPHABIO	Internal Hex Connection (IH) NEO	3,75/4,2/5	3,5	R	0040
ALPHABIO	Conical Hex Connection (CHC) NICE	3,2	Narrow	R	0136
ALPHABIO	Conical Hex Connection (CHC) NEO	3,2/3,5	Narrow	R	0136
ALPHABIO	Conical Standard Connection (CS)	3,75/4,2/5	Standard	R	0169
ANCLADEN	Anclalock	3,75/4,25/5	3,5	R	0040
ANKYLOS	Ankylos	3,5	3,5	R	0075
ANKYLOS	Ankylos	4,5	4,5	R	0075
ANKYLOS	Ankylos	5,5	5,5	R	0075
ANKYLOS	Ankylos	7	7	R	0075
ANTHOGRYR	Anthofit HE	3,5/3,75/4	R (4,1)	R	0024
ARDS	Smart	3,75/4,2/4,5	3,75	R	0040
ARDS	Classic	3,3/3,75/4,2/5/6	3,75	R	0040
ARDS	Premium	3,3/3,75/4,2/5/6	3,75	R	0040
ARDS	CIT	3,3/3,75/4,2/5/6	3,75	R	0040
ASTRA	Aqua	3,5/4	Aqua(Estrecha)	R	0004
ASTRA	Evolution (Interno)	3,6	3,6	R	0006
ASTRA	Evolution (Interno)	4,2	4,2	R	0007
ASTRA	Evolution (Interno)	4,8	4,8	R	0091
AVINENT	HE/EC	3,3/3,8/4/4,2/4,8//4,5/5	4,1	R	0024
AVINENT	HI/IC	3,1//3,5/4	3,5	R	0040



## COMPATIBILITIES AVAILABLE

BRAND	MODEL	IMPLANT Ø	PLATFORM	ROTATION	COMPATIBILITY CODE
BIOHORIZONS	Tapered Plus	3,8	3 (Grey)	R	0102
BIOHORIZONS	Tapered Plus	4,6	3,5 (Yellow)	R	0040
BIOHORIZONS	Mount-free Tapered Internal	3/3,4	3 (Grey)	R	0102
BIOHORIZONS	Mount-free Tapered Internal	3,8	3,5 (Yellow)	R	0040
BIOHORIZONS	Tapered Pro	3,8	3 (Grey)	R	0102
BIOHORIZONS	Tapered Pro	4,2/4,6	3,5 (Yellow)	R	0040
BIOHORIZONS	Tapered Short	4,6	3,5 (Yellow)	R	0040
BIOHORIZONS	Tapered PTG	4,2	3,5 (Yellow)	R	0040
BIOHORIZONS	Tapered Tissue Level	3/3,8	3,5 (Yellow)	R	0040
BIOMET 3i	Certain	3,25/4	3,4	R	0001
BIOMET 3i	Certain	4/5	4,1	R	0002
BIONER	Hikelt	3,8	3,95	R	0040
BIONER	TopDM	3,5	3,5	R	0021
BIONER	TopDM	4	4	R	0021
BIONER	TopDM	5	5	R	0021
BIOTEC	SPR/CIM	3,3	3,3	R	0040
BIOTEC	SPR/CIM	3,75	3,75	R	0040
BIOTEC	SPR/SPTT/CIM	4,2	4,2	R	0040
BIOTEC	SPR/SPTT/CIM	5	5	R	0040
BTI	Interna	3,3/3,5/3,75	3,5	R	0257
BTI	Interna Universal	3,3/3,5/3,75/4/4,25	Universal 4,1	R	0010
BTI	Interna Universal Plus	4,5/5/5,5	Universal Plus 4,1	R	0010
BTK	Klassic / Konic	3,25/4	3,5 IR	R	0040
B&W	Cónico Hexagono Interno CIH	3,3/4	4	R	0040

## COMPATIBILITIES AVAILABLE

BRAND	MODEL	IMPLANT Ø	PLATFORM	ROTATION	COMPATIBILITY CODE
CAMLOG	Conelog Screw-Line/Progressive-Line	3,3	3,3	R	0119
CAMLOG	Conelog Screw-Line/Progressive-Line	3,8	3,8	R	0120
CAMLOG	Conelog Screw-Line/Progressive-Line	4,3	4,3	R	0121
CONEXÃO SISTEMA DE PRÓTESE	Flash	3,5/4,3/5	Universal	R	0021
CONEXÃO SISTEMA DE PRÓTESE	Torq	3,5/3,75/4	Universal	R	0021
CONEXÃO SISTEMA DE PRÓTESE	Expand	3,75/4/5	Universal	R	0021
CORTEX	Internal Hex Dynamix	3,3/3,8/4,2/5/6	3,75	R	0040
CORTEX	Internal Hex Classix	3,3/3,8/4,2/5/6	3,75	R	0040
CORTEX	Internal Hex Saturn	3,8/4,2	3,5	R	0040
CORTEX	Conical Dynamix	3,3/3,8/4,2	RP	R	0004
CORTEX	Conical Classix	3,3/3,8/4,2	RP	R	0004
CORTEX	Conical Magix	3,3/3,8/4,2	RP	R	0004
DENTIS	OneQ-SL	3,9/4,2/4,7/5,2	Regular	R	0030
DENTIS	OneQ-SL	6/7/8	Wide	R	0030
DENTIS	s-Clean Tapered / Tapered II	3,7	Mini	R	0030
DENTIS	s-Clean Tapered / Tapered II	4,1/4,3	Regular	R	0030
DENTIS	s-Clean Tapered / Tapered II	4,8	Wide	R	0030
DENTIS	s-Clean Straight	4,1/4,8	4,1/4,8	R	0030
DENTIS	s-Clean Save	5,5/6	5,5/6	R	0030
DENTIS	SQ-SL	4/4,5/5	Regular	R	0030
DENTIS	SQ-SL	6/7/8	Wide	R	0030
DENTIUM	SuperLine and Implantium	3,4	3,6	R	0030
DENTIUM	SuperLine and Implantium	3,8	4	R	0030
DENTIUM	SuperLine and Implantium	4,3	4,5	R	0030

## COMPATIBILITIES AVAILABLE

BRAND	MODEL	IMPLANT Ø	PLATFORM	ROTATION	COMPATIBILITY CODE
AVINENT	HI/IC	3,3/3,8/4/4,2/4,8//4,5/5	4,1	R	0040
BIOCONCEPT	BC Bone Level	3,3	Narrow	R	0033
BIOCONCEPT	BC Bone Level	4,1/4,8	Regular	R	0035
BIOCONCEPT	BV Tapered Bone Level	3,5	Narrow	R	0029
BIOCONCEPT	BV Tapered Bone Level	4/4,5/5	Regular	R	0030
BIOGENESIS	3icon	3,75/4/4,3/4,5	Regular (Blue)	R	0024
BIOHORIZONS	Tapered Internal	3/3,4	3 (Grey)	R	0102
BIOHORIZONS	Tapered Internal	3,8	3,5 (Yellow)	R	0040
BIOHORIZONS	Tapered Plus	3,8	3 (Grey)	R	0102
BIOHORIZONS	Tapered Plus	4,6	3,5 (Yellow)	R	0040
BIOHORIZONS	Mount-free Tapered Internal	3/3,4	3 (Grey)	R	0102
BIOHORIZONS	Mount-free Tapered Internal	3,8	3,5 (Yellow)	R	0040
BIOHORIZONS	Tapered Pro	3,8	3 (Grey)	R	0102
BIOHORIZONS	Tapered Pro	4,2/4,6	3,5 (Yellow)	R	0040
BIOHORIZONS	Tapered Short	4,6	3,5 (Yellow)	R	0040
BIOHORIZONS	Tapered PTG	4,2	3,5 (Yellow)	R	0040
BIOHORIZONS	Tapered Tissue Level	3/3,8	3,5 (Yellow)	R	0040
BIOMET 3i	Osseotite External Hex	3,75/4	4,1	R	0024
BIOMET 3i	Certain	3,25/4	3,4	R	0001
BIOMET 3i	Certain	4/5	4,1	R	0002
BIONER	Ikelt / Bikelt	3,3/3,75/4	4,1	R	0024
BIONER	Hikelt	3,8	3,95	R	0040
BIONER	TopDM	3,5	3,5	R	0021
BIONER	TopDM	4	4	R	0021

## COMPATIBILITIES AVAILABLE

BRAND	MODEL	IMPLANT Ø	PLATFORM	ROTATION	COMPATIBILITY CODE
BIOTEC	SPR/CIM	3,3	3,3	R	0040
BIOTEC	SPR/CIM	3,75	3,75	R	0040
BIOTEC	SPR/SPTT/CIM	4,2	4,2	R	0040
BIOTEC	SPR/SPTT/CIM	5	5	R	0040
BTI	Externa Universal	3,75/4	Universal 4,1	R	0024
BTI	Externa Universal Plus	4,5/5	Universal Plus 4,1	R	0024
BTI	Interna	3,3/3,5/3,75	3,5	R	0257
BTI	Interna Universal	3,3/3,5/3,75/4/4,25	Universal 4,1	R	0010
BTI	Interna Universal Plus	4,5/5/5,5	Universal Plus 4,1	R	0010
BTK	Klassic / Konic	3,25PL/3,75/4	4,1 ER	R	0024
BTK	Klassic / Konic	3,25/4	3,5 IR	R	0040
B&W	Hexágono Externo	3,75/4	4,1	R	0024
B&W	Cónico Hexagono Interno CIH	3,3/4	4	R	0040
CAMLOG	Conelog Screw-Line/Progressive-Line	3,3	3,3	R	0119
CAMLOG	Conelog Screw-Line/Progressive-Line	3,8	3,8	R	0120
CAMLOG	Conelog Screw-Line/Progressive-Line	4,3	4,3	R	0121
CONEXÃO SISTEMA DE PRÓTESE	Flash	3,5/4,3/5	Universal	R	0021
CONEXÃO SISTEMA DE PRÓTESE	Torq	3,5/3,75/4	Universal	R	0021
CONEXÃO SISTEMA DE PRÓTESE	Expand	3,75/4/5	Universal	R	0021
CORTEX	Internal Hex Dynamix	3,3/3,8/4,2/5/6	3,75	R	0040
CORTEX	Internal Hex Classix	3,3/3,8/4,2/5/6	3,75	R	0040
CORTEX	Internal Hex Saturn	3,8/4,2	3,5	R	0040
CORTEX	Conical Dynamix	3,3/3,8/4,2	RP	R	0004
CORTEX	Conical Classix	3,3/3,8/4,2	RP	R	0004

## COMPATIBILITIES AVAILABLE

BRAND	MODEL	IMPLANT Ø	PLATFORM	ROTATION	COMPATIBILITY CODE
CORTEX	Conical Magix	3,3/3,8/4,2	RP	R	0004
DENTIS	OneQ-SL	3	Narrow	R	0014
DENTIS	OneQ-SL	3,9/4,2/4,7/5,2	Regular	R	0030
DENTIS	OneQ-SL	6/7/8	Wide	R	0030
DENTIS	s-Clean Tapered / Tapered II	3,7	Mini	R	0030
DENTIS	s-Clean Tapered / Tapered II	4,1/4,3	Regular	R	0030
DENTIS	s-Clean Tapered / Tapered II	4,8	Wide	R	0030
DENTIS	s-Clean Straight	4,1/4,8	4,1/4,8	R	0030
DENTIS	s-Clean Save	5,5/6	5,5/6	R	0030
DENTIS	SQ-SL	3,5	Narrow	R	0014
DENTIS	SQ-SL	4/4,5/5	Regular	R	0030
DENTIS	SQ-SL	6/7/8	Wide	R	0030
DENTIS	e-Clean	4,1	Regular	R	0024
DENTIUM	SuperLine and Implantium	3,4	3,6	R	0030
DENTIUM	SuperLine and Implantium	3,8	4	R	0030
DENTIUM	SuperLine and Implantium	4,3	4,5	R	0030
DENTIUM	SuperLine and Implantium	4,8	5	R	0030
DENTIUM	SuperLine and Implantium	4,8	6	R	0030
DIO IMPLANTS	UF II Narrow	3/3,3	Narrow	R	0014
DIO IMPLANTS	UF II	3,8/4/4,5/5/5,5	Regular	R	0030
DIO IMPLANTS	External	3,75/4/4,5	Regular 4,1	R	0024
DMI DENTAL SUPPLY	DCI/DSI	3,3/3,5/3,75/4,2/5/6	3,75	R	0040
DSP BIOMEDICAL	Hexágono Externo	3,75/4/5//3,5/3,8/4,3	4,1	R	0024
EASY IMPLANT	Master C	3,5	3,5 (Ocean)	R	0004

## COMPATIBILITIES AVAILABLE

BRAND	MODEL	IMPLANT Ø	PLATFORM	ROTATION	COMPATIBILITY CODE
EASY IMPLANT	Master C	4	4 (Ocean)	R	0004
EASY IMPLANT	Master C	4,5	4,5 (Lilas)	R	0030
EASY IMPLANT	Master C	5	5 (Lilas)	R	0030
EASY IMPLANT	Master S	3,3	3,3 (Ocean)	R	0004
EASY IMPLANT	Master S	3,75	3,75 (Lilas)	R	0030
EASY IMPLANT	Master S	4,25	4,25 (Lilas)	R	0030
EASY IMPLANT	Master S	4,75	4,75 (Lilas)	R	0030
EASY IMPLANT	Master L	3,3	3,3 (Lilas)	R	0030
EASY IMPLANT	Master L	3,75	3,75 (Lilas)	R	0030
EASY IMPLANT	Master L	4,25	4,25 (Lilas)	R	0030
EASY IMPLANT	Master L	4,75	4,75 (Lilas)	R	0030
EASY IMPLANT	Hexcel-S	3,75	4,1	R	0024
EASY IMPLANT	Hexcel-S	4,25	4,1	R	0024
ECKERMANN	Hexagon	3/3,5/4/4,5/5	4,1	R	0024
ELITE MEDICA	Conexión Externa	4	Regular	R	0024
EUROTEKNIKA	Naturactis	3,5	3,4	R	0004
EUROTEKNIKA	Naturactis	4	3,8	R	0004
EUROTEKNIKA	Naturactis	4,5	4,3	R	0004
EUROTEKNIKA	Naturactis	5	4,8	R	0004
EUROTEKNIKA	Uneva	3,6	4,1	R	0024
EUROTEKNIKA	Uneva	4,1	4,1	R	0024
EUROTEKNIKA	Uneva (Platform Switching)	4,8	4,1	R	0024
EUROTEKNIKA	Uneva (Platform Switching)	6	4,1	R	0024
EUROTEKNIKA	Natea	3,6/4,1/4,8	Narrow	R	0004

## COMPATIBILITIES AVAILABLE

BRAND	MODEL	IMPLANT Ø	PLATFORM	ROTATION	COMPATIBILITY CODE
EUROTEKNIKA	Natea	3,6/4,1/4,8	Regular	R	0004
EUROTEKNIKA	Natea	6	Wide	R	0004
EUROTEKNIKA	Naturall	3,5	Narrow	R	0004
EUROTEKNIKA	Naturall	4/4,5	Regular	R	0004
EUROTEKNIKA	Naturall	5	Wide	R	0004
F&B IMPLANT (FIT & BRILLIANT)	FA Submerged Fixture	3,9	Narrow	R	0030
F&B IMPLANT (FIT & BRILLIANT)	FA Submerged Fixture	4,1/4,4	Regular	R	0030
F&B IMPLANT (FIT & BRILLIANT)	FA Submerged Fixture	4,8	Wide	R	0030
F&B IMPLANT (FIT & BRILLIANT)	FA Submerged Fixture	5,3/5,8/6,3/6,8	Ultra-Wide	R	0030
GALIMPLANT	Conexión Externa	3,5/4	4	R	0024
GALIMPLANT	Conexión Interna	3,5	3,5	R	0004
GALIMPLANT	Conexión Interna	4	4	R	0004
GALIMPLANT	Conexión Interna	5	5	R	0004
GLOBAL D (TEKKA)	In-Kone Universal	3,5/4/4,5/5	Universal	R	0152
GLOBAL D (TEKKA)	In-Kone Primo	3,5/4/4,5/5	Universal	R	0152
GMI (ILERIMPLANT)	Phoenix	3,3/3,75/4	Standard 4,1	R	0024
GT MEDICAL	Best Fit Hexágono Externo	4,1	Regular	R	0024
HAHN IMPLANT (GLIDEWELL)	Hahn Tapered Implant	3,5/4,3	3,5/4,3	R	0021
HAHN IMPLANT (GLIDEWELL)	Hahn Tapered Implant	5	5	R	0022
HIOSSSEN	ETII SA / ETIII SA	3,5	Mini	R	0029
HIOSSSEN	ETII SA / ETIII SA / ETIV SA	4/4,5/5	Regular	R	0030
HIOSSSEN	ETIII BA	3,5	Mini	R	0029
HIOSSSEN	ETIII BA	4/4,5/5	Regular	R	0030
HI-TEC	Tapered Self Thread	3,3/3,75	3,5	R	0040

## COMPATIBILITIES AVAILABLE

BRAND	MODEL	IMPLANT Ø	PLATFORM	ROTATION	COMPATIBILITY CODE
HI-TEC	Logic Plus	3,5	3,7	R	0040
HI-TEC	Logic Plus	4,3	3,9	R	0040
IBS	Magic FC	4/4,5/5/5,5/6/6,5	3,8	R	0030
IBS	N.R. Fix	3/3,5	3,8	R	0030
IDO IMPLANTS	I Do Implant	3,8/4/4,5/5/5,5/6/7	Universal	R	0030
IHDE DENTAL (IMBIODENT)	Bone Level Plus	3,3	3,3	R	0033
IHDE DENTAL (IMBIODENT)	Bone Level Plus	4,1	4,1	R	0035
IHDE DENTAL (IMBIODENT)	Bone Level Plus	4,8	4,8	R	0035
IMPLANT DIRECT	Legacy	3,7/4,2	3,5	R	0040
IMPLANT DIRECT	SwishActive	3,3	3	R	0021
IMPLANT DIRECT	SwishActive	4,1/4,8	3,4	R	0022
IMPLANT DIRECT	Interactive	3,2/3,7	3	R	0021
IMPLANT DIRECT	Interactive	4,3/5	3,4	R	0022
IMPLANT DIRECT	Simply Iconic	3,2/3,7/4,2	Purple 3.0	R	0021
IMPLANT DIRECT	Simply Iconic	4,7/5,2/5,7	Gold 3.4	R	0022
IMPLANT GENESIS	Aktiv System	3,5/3,75/4,2/5	Standard	R	0040
IMPLANTSWISS	Bone Level	3,3	3,3	R	0004
IMPLANTSWISS	Bone Level	3,7	3,7	R	0030
IMPLANTSWISS	Bone Level	4,3	4,3	R	0030
IMPLANTSWISS	Bone Level	4,8	4,8	R	0030
IMPLANTSWISS	Bone Level	5,5	5,5	R	0030
INTRA-LOCK	Unihex	4	Regular	R	0024
INTRA-LOCK	Unihex	4,75	Wide	R	0024
INTRA-LOCK	IntraHex	3,75/4	3,5	R	0040

## COMPATIBILITIES AVAILABLE

BRAND	MODEL	IMPLANT Ø	PLATFORM	ROTATION	COMPATIBILITY CODE
JDENTALCARE	JD Evolution/JDEvolution Plus	3,7	3,7	R	0040
JDENTALCARE	JD Evolution/JDEvolution Plus	4,3/5	4	R	0040
JDENTALCARE	JD Evolution/JDEvolution Plus	6	5	R	0040
JDENTALCARE	JD Pterygo	4	4	R	0040
JDENTALCARE	JD ICON	3,9	3,9	R	0022
JDENTALCARE	JD ICON	4,3	4	R	0022
JDENTALCARE	JD ICON	5	4,7	R	0022
JDENTALCARE	JD ICON Plus	3,7	3,7	R	0015
JDENTALCARE	JD ICON Plus	4,3	4	R	0015
JDENTALCARE	JD ICON Plus	5	4,8	R	0015
JDENTALCARE	JD ICON Plus T	3,5	3,5	R	0015
JDENTALCARE	JD ICON Plus T	4	3,5	R	0015
JDENTALCARE	JD ICON Plus T	4,5	3,5	R	0015
KEYSTONE	Restore	3,75/4	RD 4,1	R	0024
KLOCKNER	KL	3,7/4,2	Regular	R	0024
LEADER	Tixos Internal Hex	3,3	3,5	R	0040
LEADER	Tixos Internal Hex	3,75	4	R	0040
LEADER	Tixos External Hex	3,3/3,75	4,1	R	0024
MEDENTIS	Premium/Active Master	3,75	3,75 (Red)	R	0125
MEDENTIS	Premium/Active Master	4,1	4,1 (Green)	R	0125
MEDENTIS	Premium/Active Master	4,8	4,8 (Blue)	R	0125
MEGAGEN	AnyRidge	3,5	Small	R	0015
MEGAGEN	AnyRidge	4/4,5	Regular	R	0015
MEGAGEN	AnyRidge	5/5,5	Wide	R	0015

## COMPATIBILITIES AVAILABLE

BRAND	MODEL	IMPLANT Ø	PLATFORM	ROTATION	COMPATIBILITY CODE
MEGAGEN	AnyOne Internal	3,5/4/4,5/5/6/7	General	R	0030
MEGAGEN	AnyOne External	4	Regular 4,1	R	0024
MEGAGEN	AnyOne External	4,5	Regular 4,5	R	0024
MEGAGEN	Mini Narrow Ridge	3/3,4	Mini	R	0014
MICRODENT	Universal	3,3/3,5/3,75/4	4,1	R	0024
MIS	Lance	3,75/4,2	Standard	R	0024
MIS	Seven	3,75/4,2	Standard	R	0040
MIS	M4	3,75/4,2	Standard	R	0040
MIS	C1	3,3	Narrow	R	0016
MIS	C1	3,75/4,2	Standard	R	0017
MIS	V3	3,9/4,3/5	Standard	R	0017
MOZO-GRAU (TICARE)	MG Osseous	3,4/3,75/4,25	4,1 Standard	R	0024
MOZO-GRAU (TICARE)	MG Inhex	3,75/4,25	2,8 Standard	R	0004
MPI	Conexión Externa HE Privilege	3,3/4	4,1	R	0024
MPI	Privilege CM	3,5/4	Regular	R	0004
MPI	Excellence CM	3,5/4	Regular	R	0004
NEOBIOTECH	IS Implant System	3,2	S-Narrow	R	0029
NEOBIOTECH	IS Implant System	3,5	Narrow	R	0030
NEOBIOTECH	IS Implant System	4	Regular	R	0030
NEOBIOTECH	IS Implant System	4,5	Regular	R	0030
NEOBIOTECH	IS Implant System	5	Wide	R	0030
NEODENT	Helix GM/Drive GM/Titamax GM	3,5/3,75/4/4,3/5/6	Regular	R	0186
NEODENT	Smart HE	3,75/4	4,1	R	0024
NOBEL BIO CARE	Branemark	3,75/4	Regular	R	0024

## COMPATIBILITIES AVAILABLE

BRAND	MODEL	IMPLANT Ø	PLATFORM	ROTATION	COMPATIBILITY CODE
NOBEL BIOCARE	Active/Replace Conical Connection	3	Mini 3.0	R	0159
NOBEL BIOCARE	Active/Replace Conical Connection	3,5	Narrow	R	0021
NOBEL BIOCARE	Active/Replace Conical Connection	4,3/5	Regular	R	0022
NOBEL BIOCARE	NobelSpeedy	4/5	Regular	R	0024
NOBEL BIOCARE	NobelParallel	3,75	Narrow	R	0021
NOBEL BIOCARE	NobelParallel	4,3/5	Regular	R	0022
NORIS MEDICAL	Tuff	3,3/3,75/4,2/5/6	3,75	R	0040
NORIS MEDICAL	Tuff TT	3,3/3,75/4,2/5/6	3,75	R	0040
NORIS MEDICAL	Onix	3,3/3,75/4,2/5/6	3,75	R	0040
NORIS MEDICAL	Cortical	4,0/5/6	3,75	R	0040
NORIS MEDICAL	PteryCore	4,2	3,75	R	0040
NORIS MEDICAL	PteryFit	4,2	3,75	R	0040
NORMON	Normoimplant HE	3,25/3,75/4,25/4,75	4,1	R	0024
OSSTEM IMPLANT	TS	3,5	Mini 3,5	R	0029
OSSTEM IMPLANT	TS	4/4,5/5/6/7	Regular	R	0030
OSSTEM IMPLANT	US	3,75/4/4,5	Regular 4,1	R	0024
OSTEOPLUS	She	3,75 / 4	4	R	0024
OSTEOPLUS	Shi	3,3 / 3,75 / 4,2	3,5	R	0040
OXY	K1 Line	3,5/4/4,5/5	Regular	R	0015
OXY	K1 Line	5,5/6/6,5	Wide	R	0015
OXY	PSK Line	3,5/4/4,5/5	Regular	R	0015
OXY	MD Line KONE	3,75/4,25/5	Regular	R	0015
OXY	MD Line Ext	3,75/4,25	Standard	R	0024
PALTOP	Conical Active	3,25/3,75/4,2/5	Standard	R	0029

## COMPATIBILITIES AVAILABLE

BRAND	MODEL	IMPLANT Ø	PLATFORM	ROTATION	COMPATIBILITY CODE
PHIBO	TSH/BNT Serie 3	3,6	4	R	0024
PHIBO	TSH/BNT Serie 4	4,2	4	R	0024
PROCLINIC	Cilindrico Externo/Cónico Externo	3,75/4,25//3,5/4	4,1 Estandar	R	0024
PROCLINIC	Cilindrico Interno/Cónico Interno	3,3/3,75/4,25/5//3,5/4/5	3,5	R	0040
PROCLINIC	Aqua CM	3,5/4/5	2,82	R	0004
RADHEX	PHE	4/4,5/5	4,1	R	0024
REFLECT	Rapid	3,0	3,0	R	0159
REFLECT	Rapid	3,5	NP	R	0021
REFLECT	Rapid	4,3/5/5,5	RP	R	0022
REFLECT	Recover	3,5	NP	R	0021
REFLECT	Recover	4,3/5	RP	R	0022
REFLECT	Aspire	3,5/4	Aqua(Estrecha)	R	0004
REFLECT	Tapered Screw	3,5	3,5	R	0040
SEWON MEDIX	IHZ SLA SYSTEM	3,5	Mini	R	0029
SEWON MEDIX	IHZ SLA SYSTEM	3,5/4/4,5/5	Regular	R	0030
SEWON MEDIX	IHZ RBM SYSTEM	3,5	Mini	R	0029
SEWON MEDIX	IHZ RBM SYSTEM	3,5/4/4,5/5	Regular	R	0030
SIGNO VINCES	Duo	4,6	4,1	R	0024
SIGNO VINCES	Inttegra	3,75/4	4,1	R	0024
SIGNO VINCES	Compact	4,5	CM3,8	R	0004
SIGNO VINCES	Duocon	3,8	CM3,8	R	0004
SIGNO VINCES	Infra	3,3/3,8/4,6	CM	R	0004
SIN IMPLANTS	HI SW	3,8	3,8	R	0039
SIN IMPLANTS	Tryon	3,25/3,75/4	4,1	R	0024

## COMPATIBILITIES AVAILABLE

BRAND	MODEL	IMPLANT Ø	PLATFORM	ROTATION	COMPATIBILITY CODE
SIN IMPLANTS	Tryon CO	4	4,1	R	0024
SIN IMPLANTS	Revolution	3,25/3,75/4	4,1	R	0024
SIN IMPLANTS	Stylus	4	4,1	R	0024
SOUTHERN IMPLANTS	External Hex	3,75/4	4,1	R	0024
SOUTHERN IMPLANTS	Deep Conical	3,5/4	2,95/3,1	R	0004
SOUTHERN IMPLANTS	Internal Hex	3,75/4,2/5	Universal	R	0040
SOUTHERN IMPLANTS	Provata	4/5/6	Standard	R	0040
STERNGOLD	STERN EX	3,75/4/5	4,1	R	0024
STRAUMANN	Bone Level	3,3	NC- 3,3	R	0033
STRAUMANN	Bone Level	4,1	RC-4,1	R	0035
STRAUMANN	Bone Level	4,8	RC-4,8	R	0035
STRAUMANN	BLX	3,5/3,75/4/4,5	RB (Regular Base)	R	0207
STRAUMANN	BLX	5/5,5/6,5	WB (Wide Base)	R	0208
STRAUMANN	TLX / TLX S	3,75/4,5	NT	R	0260
STRAUMANN	TLX / TLX S	3,75/4,5	RT	R	0261
STRAUMANN	TLX / TLX S	5,5/6,5	WT	R	0262
SYBRON IMPLANT SOLUTIONS	Endopore (Innova)	4,1	4,1	R	0024
TITANIUM-FIX	b-fix	3,5/4	Regular	R	0004
TREE-OSS	Simple	3,3/3,75/5	3,75 Amarillo	R	0040
TREE-OSS	Rapid/Anatomic	3,75/4	4,1 Amarillo	R	0024
TRI DENTAL IMPLANTS	TRI-Vent	3,75/4,1/4,7	3,5	R	0040
TRINON	Q2	3,5/3,75/4,5	4	R	0024
UFIT	Gt2	3,5	Mini	R	0004
UFIT	Nt2	3,5	Mini	R	0004

## COMPATIBILITIES AVAILABLE

BRAND	MODEL	IMPLANT Ø	PLATFORM	ROTATION	COMPATIBILITY CODE
VULKAN IMPLANTS	IN-Hex	3,3/3,75/4,2/5	3,75	R	0040
VULKAN IMPLANTS	IN-Hex	3,3/3,75/4,2/5	Universal	R	
XIVE	Xive	3,8	3,8	R	0039
YES IMPLANT	S-SYSTEM	3,3/3,5	Narrow	R	0030
YES IMPLANT	S-SYSTEM	4/4,5	Regular	R	0030
YES IMPLANT	S-SYSTEM	5/5,5	Wide	R	0030
ZIACOM	OEX	3,75/4,25	RP 4,1	R	0024
ZIMMER	Screw-Vent	3,7/4,1	3,5	R	0040
ZIMMER	TSX Implant	3,7/4,1/4,7	3,5	R	0040

# DAS MU LIBRARIES

## DAS MU premium library



### MU Scanbody

DAS\_MU\_4.5\_XXXX\*\_PREMIUM  
 DAS\_MU\_8\_XXXX\*\_PREMIUM  
 DAS\_MU\_DS8\_XXXX\*\_PREMIUM



### MU ScAnalog

DAS\_MU\_SA\_XXXX\*\_PREMIUM

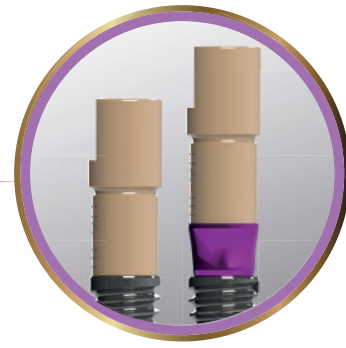

### Dynamic μScanbody

DAS\_MU\_I/IG\_XXXX\*\_PREMIUM

\*XXXX= compatibility code

# MU DAS SYSTEM COMPONENTS

 **Ratchet**  
 49.409.000.01-2

 **Screwdriver**  
 43.321.316.01-2

 **Healing Cap Regular**  
 40.320.003.88-2 (Captive screw)

 **Healing Cap Wide**  
 40.320.003.89-2 (Captive screw)

 **Impression coping**  
 29.301.000.10-2 (Engaging)  
 29.301.000.11-2 (Non-engaging)

 **Analog**  
 22.612.209.01-2

 **Titanium Abutment**  
 35.312.209.21-2

 **Digital Analog**  
 34.312.209.01-2

 **MU ScAnalog**  
 23.412.209.01-2

 **MU Scanbody 4,5mm**  
 53.412.209.01-2

 **MU Scanbody 8mm**  
 53.422.209.02-2 (R)

 **MU Dynamic μScanbody**  
 52.408.137.01-2

 **Dynamic μScanbody adaptor**  
 50.312.209.01-2

 **Screwdriver adaptor**  
 43.621.410.01-2  
 43.624.410.01-2  
 43.630.410.01-2

 **Scanbody Reference**  
 54.322.209.31-2

 **PeeK pins**  
 49.414.000.01-1 (6mm)  
 49.415.000.01-2 (9mm)  
 49.416.000.01-1 (13mm)

 **MU Dynamic TiBase®**  
 31.312.209.01-2 (Engaging)

 **MU Dynamic TiBase®**  
 31.322.209.01-2 (Non-engaging)

 **MU Dynamic 3TiBase®**  
 31.322.209.21-2 (Non-engaging)

 **Dynamic Screw**  
 41.320.040.01-2

 **Provisional (temporary) Dynamic Screw**  
 41.320.050.02-2

 **Straight Screw**  
 40.320.003.06-2

 **Dynamic Screwdriver**  
 43.618.201.01-2 (18mm)  
 43.624.201.01-2 (24mm)  
 43.632.201.01-2 (32mm)

 **Screwdriver Hex.1,2**  
 43.601.103.02-2

 **MU DMTone**  
 33.390.716.01-2 Shank Ø3  
 33.490.716.01-2 Shank Ø4  
 33.690.716.01-2 Shank Ø6



# TALLADIUM GUARANTEE

## TERMS AND CONDITIONS

These guarantee terms and conditions ("T&C") cover the entire range of Talladium products ("Products"), manufactured by TALLADIUM ESPAÑA S.L. and distributed by Geoda Medical S.L. or official dealers. The guarantee described in these T&C is exclusively in benefit of the clinician ("Clinician") and of the dental technician ("Technician") and not for the benefit of third parties or institutions, including patients.

## GUARANTEE PERIOD

TALLADIUM ESPAÑA S.L. offers a lifelong guarantee for its entire range of products starting from the date of issue of the invoice.

## GUARANTEE SCOPE

Subject to the limitations and exceptions described in these T&C, TALLADIUM ESPAÑA S.L. will offer the following benefits:

**QUALITY:** If there are defects in the materials or in the manufacturing of the Product, TALLADIUM ESPAÑA S.L. will replace the Product with no additional cost.

**SAFETY:** If, having complied with all the product indications, the prosthesis should have to be made again, due to a fault in the Dynamic Abutment® or Dynamic Titanium Base® system, TALLADIUM ESPAÑA S.L. will replace the abutments and screws necessary to remake the prosthesis, as well as the costs derived from its manufacturing.

In case of having used our products and having complied with all the product indications, the implants suffer any damage, TALLADIUM ESPAÑA S.L. will pay the cost of the implants. This coverage will only be valid during the first 6 months after the collocation of the prosthesis which includes our products.

## CLAIM REQUIREMENTS AND PROCEDURE

To receive the benefits indicated in these T&C, the treating Clinician must satisfy the following requirements:

- The claim must be notified to TALLADIUM ESPAÑA S.L. within (30) days since the date the claimed defect was detected.
- This requires that the Clinician or Technician must contact the customer service department by telephone or by e-mail to make the claim.
- A claim form will be completed, which, together with a document or report which justifies the faulty Product and the faulty Product itself, will be sent by the customer to TALLADIUM ESPAÑA S.L. offices, within the previously indicated period.
- Clinicians or Technicians presenting a claim in agreement with these T&C must be up to date in any payments owing to TALLADIUM ESPAÑA S.L. or to any of its subsidiaries, at the time when the claim form is presented.
- All the use procedures of our Products must be carried out in agreement with the instructions of TALLADIUM ESPAÑA S.L. as well as in accordance with commonly accepted dentistry practices.
- The expenses derived from this procedure will be assumed by the customer. The return shipping costs will be assumed by TALLADIUM ESPAÑA S.L. in all those cases covered by these T&C.

Regardless of the guarantee rights, claims should be notified as soon as possible in order to comply with regulatory requirements.

## GENERAL LIMITATIONS OF THIS GUARANTEE

With the exception of the guarantee described in these T&C, neither TALLADIUM ESPAÑA S.L. nor its representatives, nor third parties manufacturing or distributing the Products, represent or offer a guarantee, agreement or any other express or implicit, oral or written, commitment, with respect to the Products (without limitation), including guarantees involved in the marketing, durability or suitability for individual uses or purposes.

In addition and within the maximum extent permitted by the relative law, TALLADIUM ESPAÑA S.L. rejects (on its own behalf, and on behalf of its representatives and third parties that manufacture or distribute Products) any responsibility with respect to any direct or indirect damage caused, which may result from or be a consequence of the design, composition of the dental prosthesis into which the Products are integrated.

## GUARANTEE EXCLUSIONS

TALLADIUM ESPAÑA S.L. limits this guarantee to:

- Transformed abutments that form part of the dental prosthesis. But not the screws used to anchor them.
- Clinical screws that have been in the mouth for more than 2 years.

## AMENDMENT OR SUSPENSION OF THE GUARANTEE

TALLADIUM ESPAÑA S.L. reserves the right to amend or withdraw these T&C at any time and without prior notification. Any modification or suspension shall not affect products already placed in patients.

Ed.2019-01



VIRGINIA WOOLF, 17 · 25005 · LLEIDA (SPAIN)

INTERNATIONAL +34 973 289 580

das@dynamicabutment.com

SPAIN +34 973 289 580

spain@dynamicabutment.com



**DYNAMIC  
ABUTMENT®  
SOLUTIONS**

Virginia Woolf, 17  
25005 · Lleida (Spain)

INTERNATIONAL +34 873 450 709  
das@dynamicabutment.com

SPAIN +34 973 289 580  
spain@dynamicabutment.com



@dynamicabutmentsolutions

