

SOLUCIONES CAD-CAM

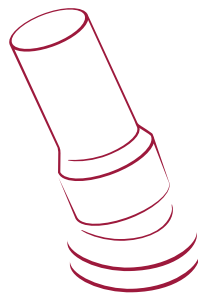

DYNAMIC
ABUTMENT®
SOLUTIONS

SOLUCIONES
CAD-CAM
2016

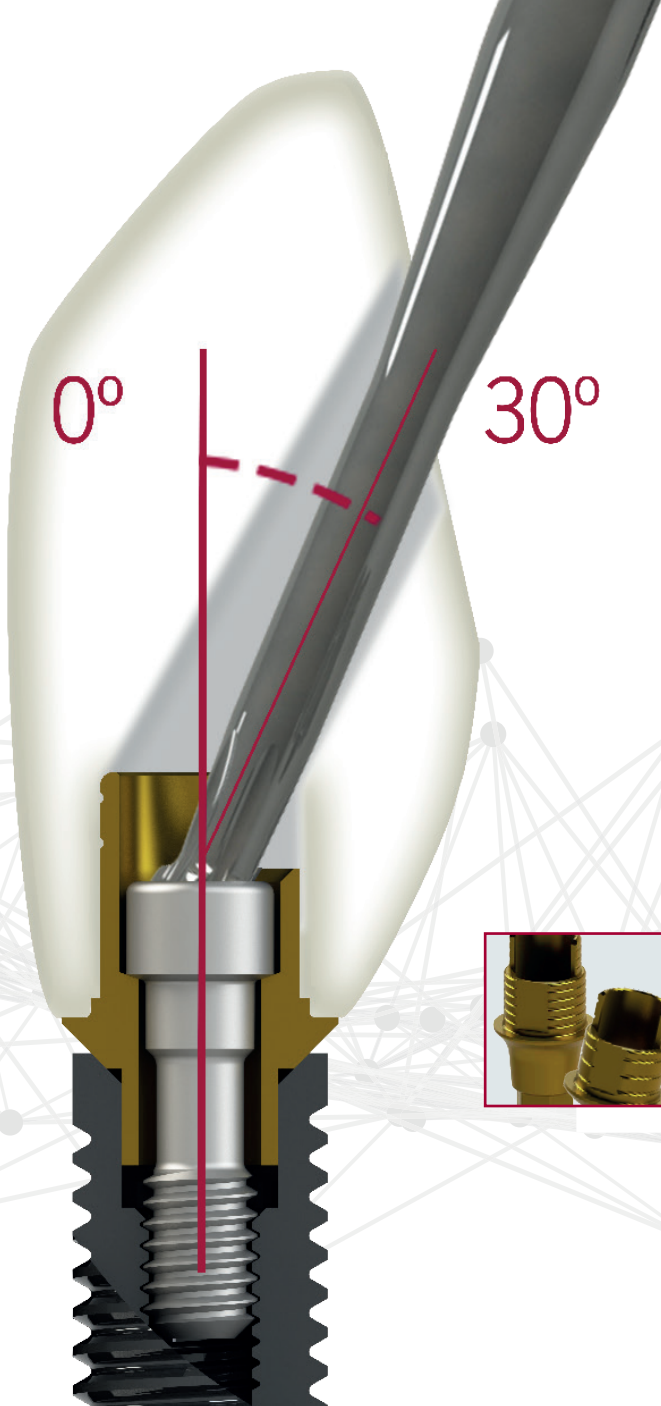
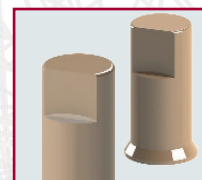

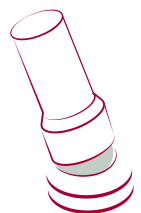

DYNAMIC
ABUTMENT®
SOLUTIONS



DYNAMIC ABUTMENT® SOLUTIONS

AV. BLONDEL, 54 3º · 25002 · LLEIDA (SPAIN)

TEL. +34 973 289 580

International: das@dynamicabutment.com

España: spain@dynamicabutment.com

www.dynamicabutment.es

Dynamic Abutment® Solutions es la marca comercial del fabricante Talladium España S.L

Todas las marcas y nombres comerciales citados en este catálogo están registradas por sus respectivas firmas. Las imágenes que aparecen son orientativas. Todas las referencias y textos de este catálogo son validos salvo error tipográfico.

Talladium España s.l se reserva el derecho de modificar este documento sin previo aviso.

Talladium España s.l no se hace responsable del buen funcionamiento de sus productos si no se contemplan las indicaciones correspondientes a cada referencia.

La información que se muestra en este catálogo está dirigida exclusivamente al profesional del sector dental.

 Aprobación, mediante organismo notificado, del aseguramiento del sistema de calidad total según normativa comunitaria, para productos sanitarios de clase IIB.

Clase IIB incluye: tornillos, interfases y bloques.



Encuentre todas las compatibilidades de nuestros productos en nuestra tienda online (Solo España):

www.dynamicabutmentstore.es





Dynamic Abutment® Solutions es la marca que engloba, entre otros, la totalidad de los productos diseñados por nuestro centro de I+D+i, para proveer soluciones que resuelvan los problemas de posicionamiento desfavorable de los implantes mejorando la estética y funcionalidad de la prótesis.

Apostamos por la innovación y damos respuesta a las nuevas exigencias del sector. Nos adaptamos a las necesidades de nuestros clientes.

En este sentido hemos incorporado nuevos productos al mercado como la Interfase Dinámica® con su aportación tecnológica al tratamiento digital para la elaboración de prótesis con canal angulado mediante Cad-Cam: el sistema consta de la Interfase Dinámica®, el conjunto tornillo-destornillador Dinámico, scanbodies y librerías disponibles para los principales softwares Cad del mercado.

Hoy en día Dynamic Abutment® Solutions presenta nuevos desarrollos con tecnología propia aplicados al campo del diseño digital. Una amplia cartera de productos desarrollados como parte de un completo sistema para cad-cam, que incluye además todos los recursos digitales precisos para resolver la complejidad de las angulaciones en un entorno cad-cam, permitiendo correcciones de ángulo de hasta 30°.

La tecnología aportada para el tratamiento de las angulaciones en todos los procesos de trabajo necesarios para elaborar prótesis dentales, desde los más tradicionales a las últimas técnicas digitales, ha sido desarrollada y patentada por nuestro Centro de I+D+i dentro del programa ANGULATED OWN TECHNOLOGY que asegura el tratamiento óptimo de los casos de angulaciones en la elaboración de prótesis dentales. La innovación y la calidad de nuestros productos son nuestro principal objetivo para responder a las exigencias del sector y de nuestros clientes.

Esteban Xam-mar
CEO Dynamic Abutment Solutions



Angulated
Own Technology
DYNAMIC ABUTMENT® SOLUTIONS

INDÍCE

3	<i>EMPRESA</i>
6	<i>DEPARTAMENTO DE INVESTIGACIÓN Y DESARROLLO</i>
6	<i>ATENCIÓN AL CLIENTE</i>
7	<i>CENTRO DE CALIDAD</i>
7	<i>DEPARTAMENTO INTERNACIONAL</i>
8	<i>SISTEMA DINÁMICO PARA ESTRUCTURAS FRESADAS</i>
9	<i>SEGURIDAD & TRAZABILIDAD</i>
10	<i>INTERFASE DINÁMICA® 3.0</i>
11	<i>SCANBODY DE PEEK PARA INTERFASE DINÁMICA® 3.0</i>
12	<i>PROCESO DE ESCANEO Y SOFTWARE CAD</i>
13	<i>SOFTWARE CAD</i>
14	<i>DISEÑO CAM</i>
15	<i>TRABAJO REALIZADO CON 3SHAPE E INTERFASE DINÁMICA® 3.0</i>
16	<i>CILINDROS PRE-FRESADOS</i>
18	<i>RÉPLICAS / TORNILLOS RECTOS / COMPLEMENTOS</i>
19	<i>COMPATIBILIDADES INTERFASE DINÁMICA® 3.0</i>
51	<i>COMPATIBILIDADES CILINDRO PRE-FRESADO</i>
83	<i>SOPORTES PARA CILINDROS PRE-FRESADOS</i>
84	<i>TORNILLOS DINÁMICOS</i>
85	<i>DESTORNILLADOR DINÁMICO</i>
86	<i>TORNILLOS RECTOS</i>
87	<i>DESTORNILLADORES PILARES MECANIZADOS</i>

3.0 TI-BASE COMPATIBILITIES

COMPATIBILIDADES INTERFASE DINÁMICA® 3.0

ACE	B&W	KEYSTONE
ADIN	CAMLOG	KLOCKNER
ALPHABIO	CONEXÃO SISTEMA DE PROTESE	LEADER
ANCLADEN	CORTEX	MEGAGEN
ANTHOGRYR	DENTALTECH	MICRODENT
ARDS	DENTIS	MIS
ASTRA	DENTIUM,	MOZO GRAU
AVINENT	DIO IMPLANTS	MPI
BIOGENESIS	DSP BIOMEDICAL	NEOBIOTECH
BIOHORIZON,	ELITE MEDICAL	NEODENT
BIOMET 3I	EUROTEKNIKA	NOBEL BIOCARE
BIOLOK	GALIMPLANT	OSSEOLIFE
BIONER	GMI	OSSTEM IMPLANT
BTI	GT MEDICAL	OSTEOPLUS
BTK	HI-TECH	PHIBO
	IMBIODENT	PROCLINIC
	IMPLANT DIRECT	RADHEX
	JDENTALCARE	SGS
		SIGNO VINCES
		STRAUMANN
		SYBRON IMPLANTS SOLUTIONS
		TITANIUM-FIX
		TRI DENTAL IMPLANTS
		TRINON
		XIVE
		ZIMMER

Ver índice compatibilidades completo. Pág. 19

PRE-MILLED ABUTMEN BLANKS COMPATIBILITIES

COMPATIBILIDADES CILINDROS PRE-FRESADOS

ACE	IMPLANT DIRECT	SIGNO VINCES
ADIN	JDENTALCARE	STRAUMANN
ALPHABIO	KEYSTONE	SYBRON IMPLANTS SOLUTIONS
ANCLADEN	KLOCKNER	TITANIUM-FIX
ANTHOGRYR	LEADER	TRI DENTAL IMPLANTS
ARDS	MEGAGEN	TRINON
ASTRA	MICRODENT	ZIMMER
AVINENT	MIS	
BIOGENESIS	MOZO GRAU	
BIOHORIZON	MPI	
BIOMET 3I	NEODENT	
BIONER	NOBEL BIOCARE	
BTI	OSSEOLIFE	
BTK	OSSTEM IMPLANT	
B&W	OSTEOPLUS	
CAMLOG	PHIBO	
CORTEX	PROCLINIC	
DENTALTECH	RADHEX	
DENTIUM	SGS	
DIO IMPLANTS		
DSP BIOMEDICAL		
ELITE MEDICAL		
EUROTEKNIKA		
GALIMPLANT		
GMI		
GT MEDICAL		
HI-TECH		
IMBIODENT		

Ver índice compatibilidades completo. Pág. 51



DEPARTAMENTO DE INVESTIGACIÓN & DESARROLLO

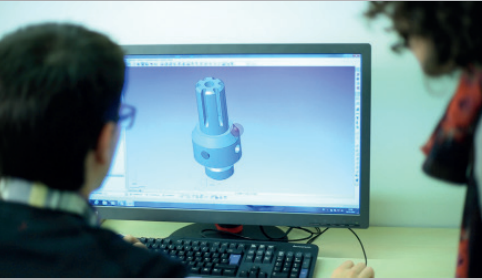

La investigación e innovación en soluciones protésicas son el sello distintivo que mantiene a Dynamic Abutment Solutions® como el referente en sistemas angulados.

La proximidad a las necesidades de los profesionales y la filosofía innovadora de la marca permiten a nuestro equipo técnico estar a la vanguardia del sector en el desarrollo de producto, desarrollo en el que priman a su vez las máximas prestaciones que aporta el producto, la facilidad de uso en cada trabajo y la mejora del resultado estético.



ATENCIÓN AL CLIENTE

El centro exclusivo de Atención al Cliente responde a sus consultas y necesidades de inmediato, con soporte directo del departamento técnico de I+D para resolver los casos más técnicos y complejos.



CENTRO DE CALIDAD



Disponemos de un Centro de Calidad propio para garantizar que todos nuestros productos cumplen con los más altos niveles de calidad, así como la normativa sanitaria en vigor. Dotado de las últimas tecnologías en cuanto a control y medición, así como tratamientos físico-químicos de nuestros productos. Dispone de sala blanca ISO-8.

DEPARTAMENTO INTERNACIONAL



Nuestro departamento internacional sigue proyectando y consolidando nuestros productos y servicios integrales a nivel mundial con presencia en mercados de más de 30 países.

SISTEMA DINÁMICO PARA ESTRUCTURAS FRESADAS

El conjunto tornillo-destornillador del sistema Pilar Dinámico® 3.0 se utiliza en aquellos casos en los que es necesario rectificar la entrada de los tornillos debido a una posición desfavorable de los implantes, mejorando así la funcionalidad y estética de las estructuras fresadas.

Destornillador Dinámico

Destornillador con cabeza hexalobular, exclusivo del sistema Pilar Dinámico® 3.0; longitudes: 18 -24 -32mm.

Vástago con conexión para contra ángulo para facilitar su uso con carraca dinamométrica o manual mediante los adaptadores o mangos correspondientes.

Tornillos Dinámicos

Abarcan todas las métricas de rosca de implante disponibles en el mercado. Se utilizan junto al Pilar Dinámico® 3.0, a la Interfase Dinámica® 3.0 o para estructuras fresadas con canal de orificio de tornillo angulado hasta 30°: por ello disponemos de varias longitudes de cada métrica para facilitar la adaptación a sus estructuras.

Todos los tornillos se entregan perfectamente identificados con su número de lote y referencia, permiten la correcta trazabilidad y registro de cada tornillo en el carnet para el paciente y en el historial clínico o del laboratorio.

Se deben manipular exclusivamente con el destornillador Dinámico 3.0. Todos están fabricados en Titanio grado V.

SEGURIDAD & TRAZABILIDAD

Dynamic Abutment Solutions es fabricante de la gama de productos “Sistema Dinámico 3.0”, que engloba al Pilar Dinámico®, el sistema tornillo y destornillador Dinámico y la Interfase Dinámica. Todos ellos son productos exclusivos y **patentados**, y elaborados siguiendo unos criterios de calidad muy estrictos.

Dynamic Abutment Solutions entrega junto al Sistema Dinámico 3.0 un carnet para el paciente junto a las respectivas etiquetas para identificar la posición dental en la que se ha colocado nuestro sistema en la ficha del paciente en clínica y laboratorio.

Es de suma importancia que estos datos queden registrados en el historial del paciente, para futuras reposiciones de material y conocer que debe utilizar un destornillador especial para colocar y retirar la prótesis realizada con el Sistema Dinámico y así evitar futuros contratiempos. Se consigue así mantener un control exhaustivo de la trazabilidad de nuestros productos, que además de dar cumplimiento a la normativa sanitaria vigente, facilita la reposición del material y el conocimiento del instrumental más adecuado para manipular los componentes del Sistema Dinámico.

Exclusividad

Todos nuestros productos son marcados en el proceso de fabricación para garantizar la exclusividad de cada pieza y controlar la trazabilidad.

Este logotipo es único y exclusivo de Dynamic Abutment® Solutions y garantiza que los productos son originales y han superado con éxito los más altos estándares de nuestro Centro de Calidad



Carnet para el paciente



Etiquetas identificativas



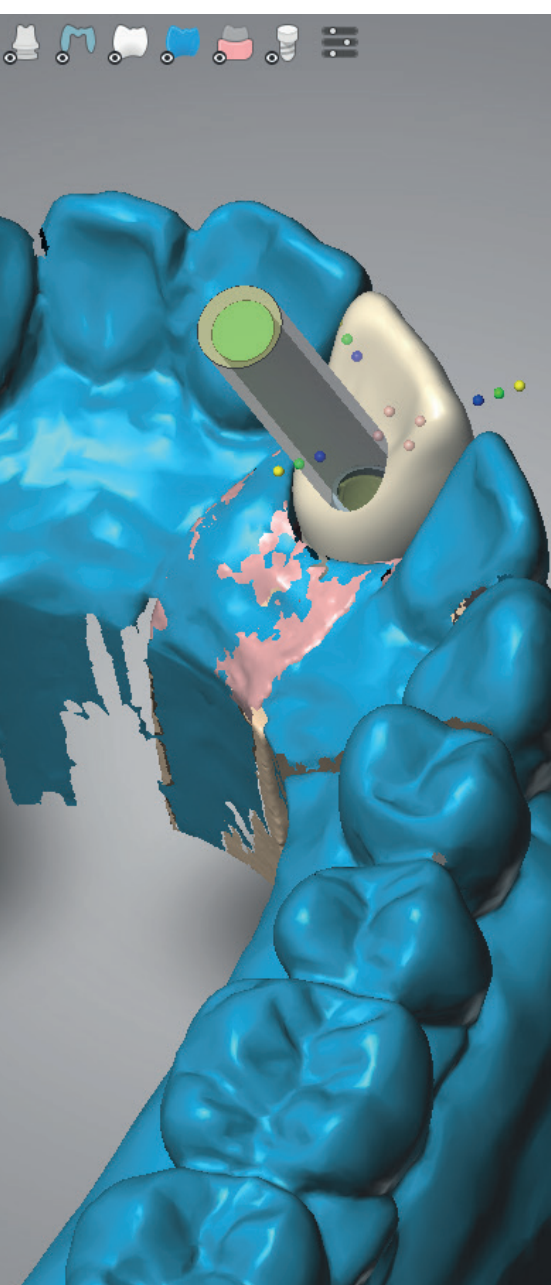

INTERFASE DINÁMICA® 3.0

Tecnología

Interfase de Titanio grado V con un anodizado dorado para mejorar la estética del trabajo. Para estructuras en Cad-Cam fabricadas en Zirconio, metal y PMMA, para aportar soluciones a las prótesis individuales y múltiples en la corrección del posicionamiento desfavorable del implante. Con la Interfase Dinámica protegemos y mejoramos la acción mecánica de fijación de la prótesis con el tornillo y contacto de la estructura con el implante en Titanio.

Se reducen los fracasos de rotura en estructuras de Zirconio y se mejora el ajuste pasivo en estructuras de metal, pudiendo en ambos casos corregir angulaciones.

La interfase está diseñada para trabajar con el conjunto tornillo-destornillador del sistema Pilar Dinámico® 3.0, disponiendo de toda la seguridad que proporciona el conjunto del sistema Pilar Dinámico® 3.0. Corrección de la angulación de 0° a 30°.

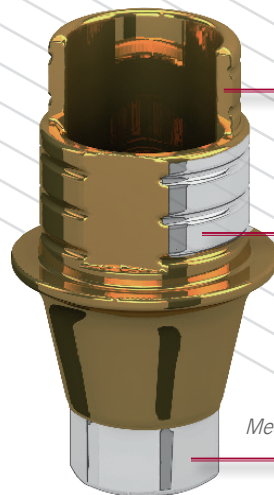

Cajeado lateral que permite la entrada del tornillo y destornillador Dinámico

Retenciones exteriores que aseguran un buen agarre con el cemento

Mecanizado de precisión de hasta +/- 5 micras

Plataforma estrecha: máxima angulación 25°

Plataforma regular/ancha: máxima angulación 30°

SCANBODY DE PEEK PARA INTERFASE DINÁMICA® 3.0

Ref. SBIND3MURP/PK

Ref. SBIND3RP/PK



Ref. SBIND3NP/PK

Ref. SBIND3OCR/PK

Detecta la posición y orientación del implante dental o del análogo en los procesos de escaneo. Solo es preciso disponer de cuatro scanbodies para usar las más de 240 compatibilidades.

Ajuste perfecto

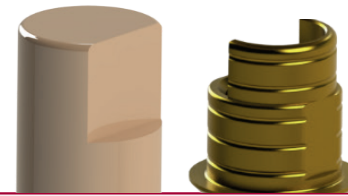

Z Posición

XY Orientación

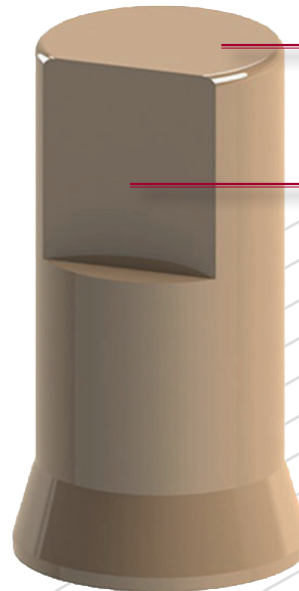

PROCESO DE ESCANEEO Y SOFTWARE CAD

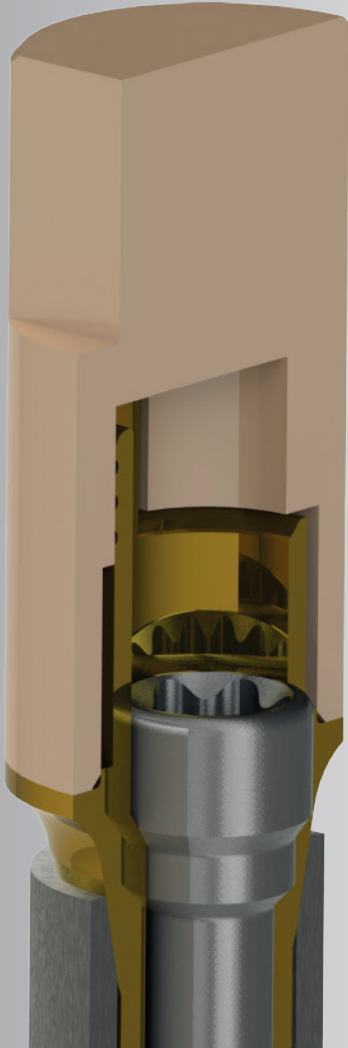

El scanbody se fija y se ajusta perfectamente a la Interfase Dinámica® 3.0 gracias a su diseño impidiendo su rotación.

A continuación se procede al escaneo del Scanbody y se detecta con precisión la posición del implante.

Gracias a la versatilidad de la Interfase Dinámica 3.0 pueden conseguirse trabajos altamente estéticos, angulando la entrada del tornillo de 0° hasta 30°, utilizando el tornillo y destornillador del sistema Pilar Dinámico® 3.0

Asistencia Técnica

Desde nuestro Servicio de atención al Cliente (Tel +34 973 289 580), ofrecemos asistencia inmediata para cualquier consulta y para la instalación de las librerías de software CAD.

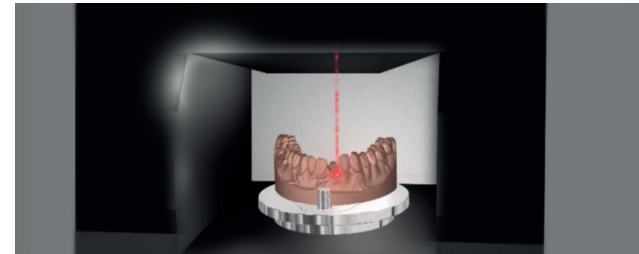
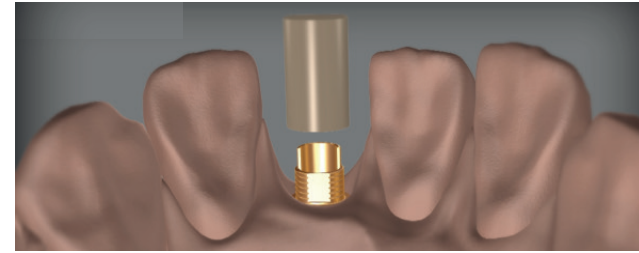

SOFTWARE CAD

La tecnología CAD/CAM representa en estos momentos la apuesta más innovadora en la elaboración de prótesis sobre implante y supone un avance en las restauraciones protésicas convencionales, permitiendo el diseño de rehabilitaciones extremadamente precisas y de mayor calidad.

Las Interfase Dinámica® 3.0 de Dynamic Abutment® Solutions es una aportación tecnológica al tratamiento digital para la elaboración de sistemas angulados mediante CAD-CAM: el sistema dinámico incluye la Interfase Dinámica®, el conjunto tornillo-destornillador Dinámico, scanbodies y librerías disponibles para los principales softwares CAD del mercado: Exocad, 3Shape, Dentalwings, Imetric y EGS.

3shape 

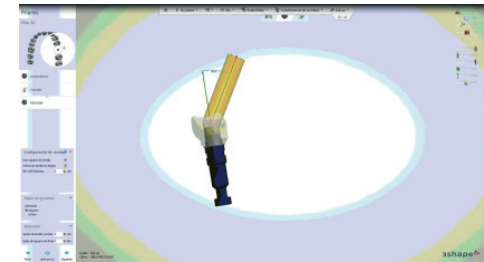

exocad
Imetric

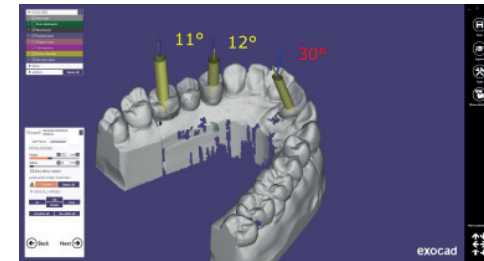

 dental wings

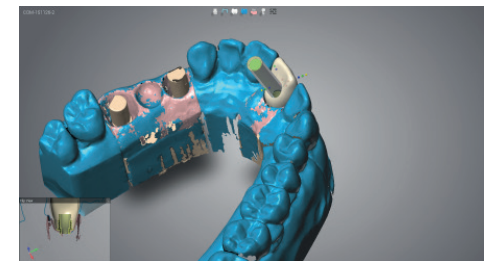

egs
Enhanced Geometry Solutions

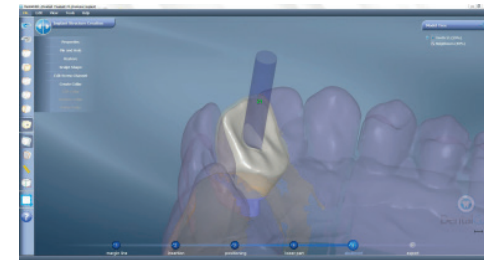

DISEÑO CAM

Adaptarse a las tecnologías más innovadoras en la industria dental es uno de los objetivos de Dynamic Abutment® Solutions, así como asegurar que nuestros clientes puedan utilizarlos de una manera sencilla. Por lo tanto, y como resultado de nuestra colaboración con los principales desarrolladores de software CAM, nuestros productos fueron testeados con éxito.

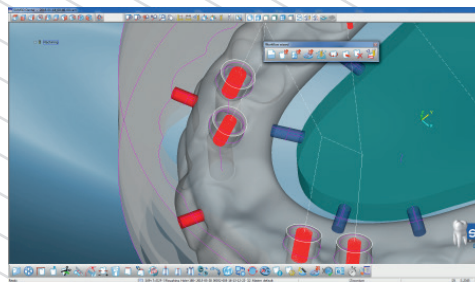
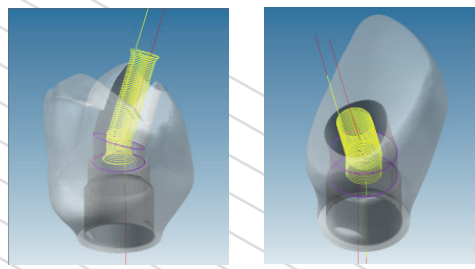
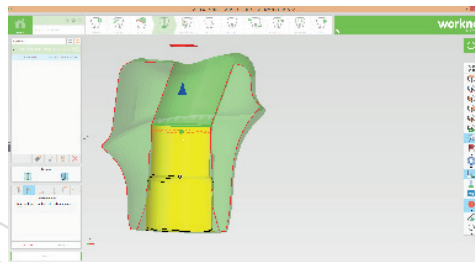

TRABAJO REALIZADO CON 3SHAPE E INTERFASE DINÁMICA® 3.0

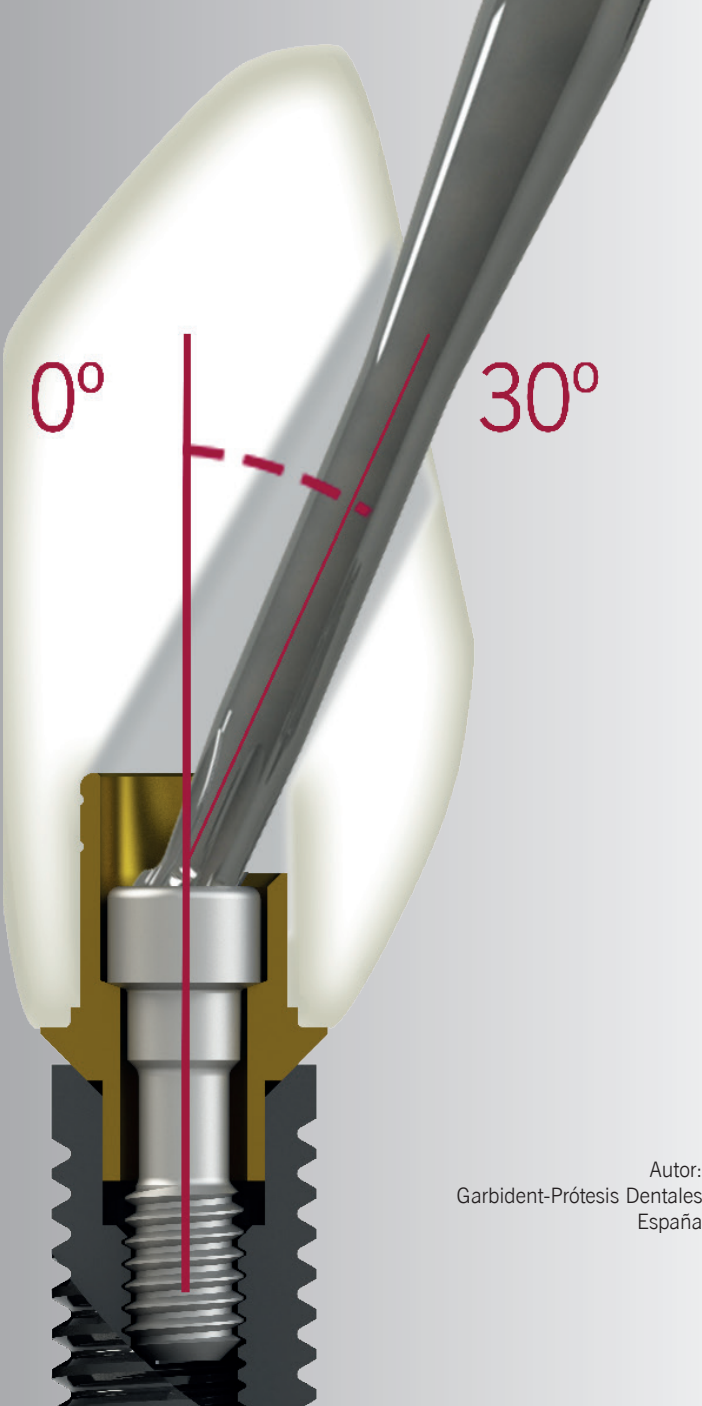

Autor:
Garbident-Prótesis Dentales
España

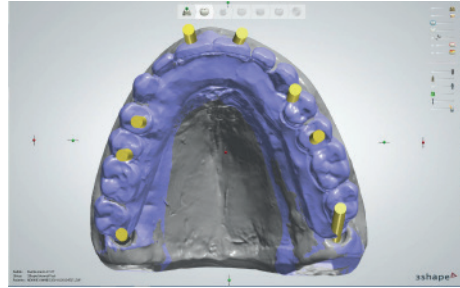

Esta imagen muestra las chimeneas anguladas de acuerdo con el diseño previo.

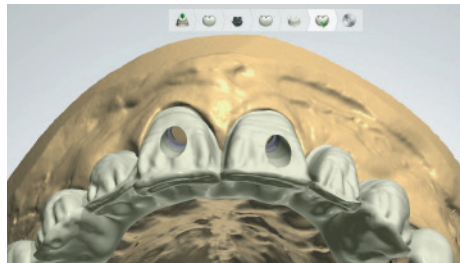
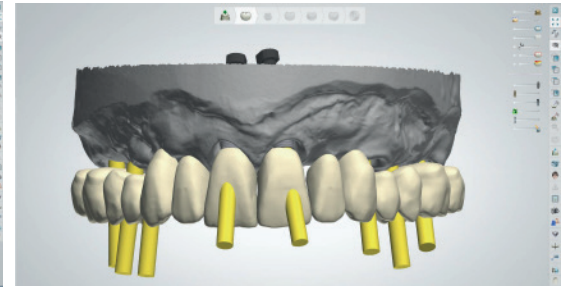

Ver el ángulo de los agujeros de los tornillos, sin corrección del ángulo.

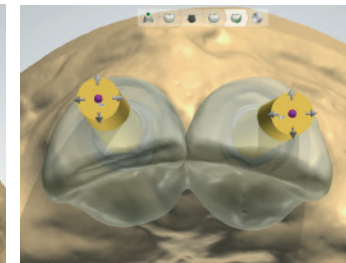

Diseño de la estructura sin angulación.

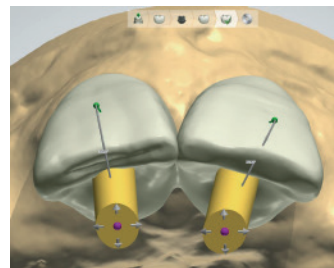
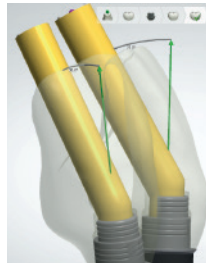

Diseño de la estructura con 30° de angulación.



Resultado de la restauración después del proceso de fabricación.

CILINDROS PRE-FRESADOS

Los nuevos cilindros con la conexión pre-mecanizada fabricados en Titanio para cementar y en Cromo-cobalto para cargar cerámica, han sido mecanizados con unos ajustes en la conexión de hasta ± 5 micras.

Estos cilindros disponen de una sujeción en la zona posterior con una geometría en V de diseño propio que asegura su posición en máquina con total precisión, unificando así en un único soporte universal todas las conexiones de implantes.



Sujeción con
geometría
en V

Este tipo de sujeción protege la conexión del implante durante todo el proceso de fresado al quedar libre de esfuerzos mecánicos. Compatibles con un amplio listado de sistemas de implantes.

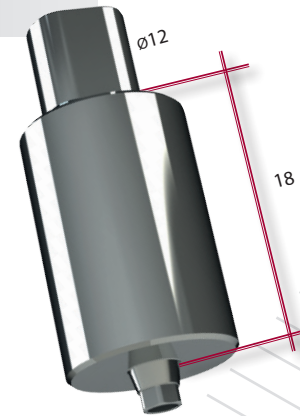

Mecanizado de precisión hasta ± 5 micras

Optimizado para una mejor estrategia de fresado

Un único soporte universal para todos los cilindros

Reducción de costes y tiempo

Se entregan conjuntamente con tornillo

El sistema de sujeción posterior protege la conexión al quedar libre de esfuerzos mecánicos durante el proceso de fresado.



Soporte para máquinas CNC con cabezal rotatorio compatible con el sistema EROWA 10x10.

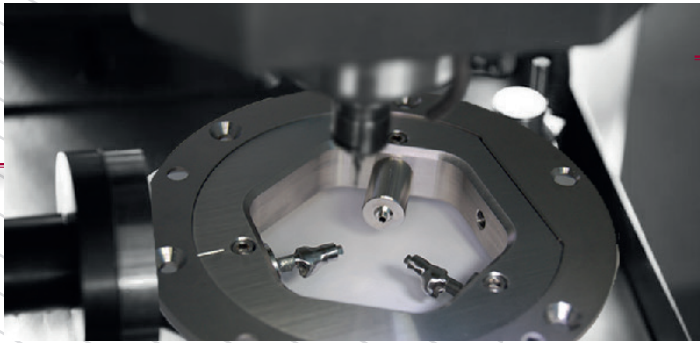

Soporte tipo disco estándar de diámetro de 98mm para posicionar de manera rápida y precisa 3 cilindros con sujeción posterior a la conexión del implante.

En caso de ser de su interés, podemos diseñar y fabricar el soporte a medida para su máquina de fresado.



Titanium grado V
ISO 5832-3

Para cementar coronas individualizadas

Cromo Cobalto
ISO 5832-12

Para aplicar cerámica directamente



RÉPLICAS



Réplica de implante realizado en acero inoxidable, reproduce la conexión del implante.

TORNILLOS RECTOS

Abarcan todas las métricas de rosca de implante disponibles en el mercado. Disponibles varias longitudes de cada métrica para facilitar la adaptación a sus estructuras fresadas. Fabricados en Titanio grado V.



COMPLEMENTOS



Mango manual

Fabricados en acero inoxidable. Se utilizan para conectar las puntas de destornillador con conexión de contra ángulo.

Mango manual largo para laboratorio Ref. MNLB

Ideal para la manipulación de modelos en el laboratorio.
Longitud: 55,65mm.



Mango manual para clínica Ref. MNCL80

Mango de clínica: se utiliza para colocar la prótesis en boca antes del control de torque en la clínica.
Longitud: 15,65mm



Carraca Universal Ref. CCUNI

Carraca dinamométrica de conexión cuadrada de 4mm. Torque 10-35N.cm

Adaptadores para carraca

Pieza que conecta la punta de destornillador con conexión a contraángulo con la carraca dinamométrica.



Adaptadores para carraca universal
Ref. MNADPCA
Conexión cuadrada 4mm



Adaptadores para carraca Straumann
Ref. SPACC-STR
Conexión tipo Straumann

3.0 TI-BASE COMPATIBILITIES

COMPATIBILIDADES INTERFASE DINÁMICA® 3.0

ACE, 20

External Hex.
Infinity TRI-CAM
Infinity Internal Hex.

ADIN, 20

Swell
Touareg-S/Touareg-OS
Touareg CloseFit

ALPHABIO, 21

External Alphabio
Alphabio Externo
Internal Alphabio
Alphabio Interno

ANCLADEN, 22

Anclalock

ANTHOGYR, 22

Anthofit HE
Ossfit

ARDS, 22

Smart
Classic
Premium

ASTRA, 23

Aqua
Lilac
Uni Abutment
Evolution

AVINENT, 24

HE
HI
Transepitelial

BIOGENESIS, 25

3Icon
Aticon
Iticon

BIOHORIZON, 25

Internal
Interno

BIOMET 3I, 26

Osseofite
Certain

BIOLOK, 26

External Hexagon
Hexágono Externo

BIONER, 26

Ikelt/Bikelt
Hikelt
TopDM
Multi-Unit

BTI, 27

External Connection
Conexión Externa
Internal Connection
Conexión Interna

BTK, 28

Klassik/Konic

B&W, 28

External Connection
Conexión Externa

CAMLOG, 28

Screw-Line

CONEXÃO SISTEMA

DE PRÓTESE, 28

AR-Morse

CORTEX, 29

Dynamix
Classix
Saturn

DENTALTECH, 29

Implogic

DENTIS, 30

S-Clean

DENTIUM, 30

SuperLine and Implantium
SimpleLine II

DIO IMPLANTS, 30

SM System
UF II Narrow
UF II
External

DSP BIOMEDICAL, 31

External Hexagon
Hexágono Externo

ELITE MEDICAL, 31

External Connection
Conexión Externa

EUROTEKNIKA, 32

Naturactis
Uneva
Uneva (Platform Switching)
Natea
Aesthetic
Natural

GALIMPLANT, 33

External Connection
Conexión Externa
Internal Connection
Conexión Interna

GMI, 33

Phoenix
Frontier

GT MEDICAL, 34

Best Fit Internal Octagon
Best Fit Octógono Interno
Best Fit Internal Hexagon
Best Fit Hexágono Interno
Best Fit External Hexagon
Best Fit Hexágono Externo

HI-TECH, 35

Self Thread STL
Self Thread GTI
LGI Plus

IMBIODENT, 35

Imbiódent

IMPLANT DIRECT, 36

Replis/Replant/Reactive
Legacy
Swishplant/Swishplus
Interactive

JDENTALCARE, 37

JDEvolution

KEYSTONE, 37

Restore

KLOCKNER, 37

KL

LEADER, 38

Tixos Internal Hexagon
Tixos Hexágono Interno
Tixos External Hexagon
Tixos Hexágono Externo

MEGAGEN, 38

AnyRidge
AnyOne Internal
AnyOne Interno
AnyOne External
AnyOne Externo

MICRODENT, 39

Mini
Universal
Ektos

MIS, 40

Lance
Seven
M4
C1
V3
Multi-Unit

MOZO GRAU, 41

MG Osseous
MG Inhex

MPI, 41

External Connection EH
Conexión Externa EH
Internal Connection CM
Conexión Interna CM

NEOBIOTECH, 42

EB External System
Sistema Externo EB

NEODENT, 42

Cono Morse Mini Pilar
Smart HE

NOBEL BIOCARE, 42

Branemark
Multi-Unit
Replace
Active

OSSEOLIFE, 43

OEX

OSSTEM IMPLANT, 44

TS
US

OSTEOPLUS, 44

She
Shi

PHIBO, 45

TSH/BTN Serie 3
TSH/BTN Serie 4

PROCLINIC, 45

External Connection
Conexión Externa
Internal Hexagon
Hexágono Interno
Internal Octagon
Octógono Interno

RADHEX, 46

PHE
PHI

SGS, 46

P1
P7

SIGNO VINCES, 47

Compact 4,5
Duo
Duocon 3,8
Integra

STRAUMANN, 48

Internal Octagon
Octógono Interno
Bone Level

SYBRON IMPLANTS

SOLUTIONS, 48

Endopore (Innova)

TITANIUM-FIX, 49

b-fix

TRI DENTAL

IMPLANTS, 49

Tri-Vent

TRINON, 49

Q2
QK

XIVE, 50

Internal
Interno

ZIMMER, 50

Screw-Vent
Swiss-Plus

Compatible with - *Compatible con* ACE

External Hex. - ACE



Platform		Non-Engaging	Engaging	Dynamic screw	Straight screw	Scanbody	Analog	Library code
Plataforma		Rotatorio	No Rotatorio	Tornillo Dinámico	Tornillo recto	Scanbody	Réplica	Código biblioteca
NP	Titanium Titanio	IND3UCS35/TIA	IND3UCH35/TIA	TPDH16L6	TBRA16L70	SBIND3NP/PK	RUC35	DAS_E_0023
RP	Titanium Titanio	IND3UCS41/TIA	IND3UCH41/TIA	TPDH2L6	TBRA2L70	SBIND3RP/PK	RUC41	DAS_E_0024



	Hex.	h.
NP	2,40	0,70
RP	2,70	0,70

Infinity TRI-CAM - ACE



NP	Titanium Titanio	IND3RPLR35/TIA	IND3RPLT35/TIA	TPDH18L75	TRPL18L83	SBIND3NP/PK	RRPL35	DAS_E_0026
RP	Titanium Titanio	IND3RPLR43/TIA	IND3RPLT43/TIA	TPDH2L90	TRPL2L100	SBIND3RP/PK	RRPL43	DAS_E_0027
WP	Titanium Titanio	IND3RPLR50/TIA	IND3RPLT50/TIA	TPDH2L90	TRPL2L100	SBIND3RP/PK	RRPL50	DAS_E_0028

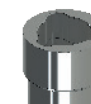

Infinity Internal Hex. - ACE



NP	Titanium Titanio	IND3ZIMR35/TIA	IND3ZIMH35/TIA	TPDH17L71	TZIML76	SBIND3NP/PK	RZIM35	DAS_E_0040
RP	Titanium Titanio	IND3ZIMR45/TIA	IND3ZIMH45/TIA	TPDH17L71	TZIML76	SBIND3RP/PK	RZIM45	DAS_E_0041



Compatible with - *Compatible con* ADIN

Swell - ADIN



Platform		Non-Engaging	Engaging	Dynamic screw	Straight screw	Scanbody	Analog	Library code
Plataforma		Rotatorio	No Rotatorio	Tornillo Dinámico	Tornillo recto	Scanbody	Réplica	Código biblioteca
Ø 3,3	Titanium Titanio Friction-Fit	IND3ZIMR35/TIA	IND3ZIMH35/TIA IND3ZIOHNP/TIA	TPDH17L71	TZIML76	SBIND3NP/PK	RZIM35	DAS_E_0040
Ø 3,75	Titanium Titanio Friction-Fit	IND3ZIMR35/TIA	IND3ZIMH35/TIA IND3ZIOHNP/TIA	TPDH17L71	TZIML76	SBIND3NP/PK	RZIM35	DAS_E_0040
Ø 4,2	Titanium Titanio Friction-Fit	IND3ZIMR35/TIA	IND3ZIMH35/TIA IND3ZIOHNP/TIA	TPDH17L71	TZIML76	SBIND3NP/PK	RZIM35	DAS_E_0040
Ø 5	Titanium Titanio Friction-Fit	IND3ZIMR35/TIA	IND3ZIMH35/TIA IND3ZIOHNP/TIA	TPDH17L71	TZIML76	SBIND3NP/PK	RZIM35	DAS_E_0040
Ø 6	Titanium Titanio Friction-Fit	IND3ZIMR35/TIA	IND3ZIMH35/TIA IND3ZIOHNP/TIA	TPDH17L71	TZIML76	SBIND3NP/PK	RZIM35	DAS_E_0040



Compatible with - *Compatible con* ADIN

Touareg-S/Touareg-OS - ADIN



Platform		Non-Engaging	Engaging	Dynamic screw	Straight screw	Scanbody	Analog	Library code
Plataforma		Rotatorio	No Rotatorio	Tornillo Dinámico	Tornillo recto	Scanbody	Réplica	Código biblioteca
Ø 3,5	Titanium <i>Titanio Friction-Fit</i>	IND3ZIMR35/TIA	IND3ZIMH35/TIA IND3ZIOHNP/TIA	TPDH17L71	TZIML76	SBIND3NP/PK	RZIM35	DAS_E_0040
Ø 3,75	Titanium <i>Titanio Friction-Fit</i>	IND3ZIMR35/TIA	IND3ZIMH35/TIA IND3ZIOHNP/TIA	TPDH17L71	TZIML76	SBIND3NP/PK	RZIM35	DAS_E_0040
Ø 4,2	Titanium <i>Titanio Friction-Fit</i>	IND3ZIMR35/TIA	IND3ZIMH35/TIA IND3ZIOHNP/TIA	TPDH17L71	TZIML76	SBIND3NP/PK	RZIM35	DAS_E_0040
Ø 5	Titanium <i>Titanio Friction-Fit</i>	IND3ZIMR35/TIA	IND3ZIMH35/TIA IND3ZIOHNP/TIA	TPDH17L71	TZIML76	SBIND3NP/PK	RZIM35	DAS_E_0040
Ø 6	Titanium <i>Titanio Friction-Fit</i>	IND3ZIMR35/TIA	IND3ZIMH35/TIA IND3ZIOHNP/TIA	TPDH17L71	TZIML76	SBIND3NP/PK	RZIM35	DAS_E_0040



Touareg CloseFit - ADIN



Platform		Non-Engaging	Engaging	Dynamic screw	Straight screw	Scanbody	Analog	Library code
Plataforma		Rotatorio	No Rotatorio	Tornillo Dinámico	Tornillo recto	Scanbody	Réplica	Código biblioteca
RP Ø 3,5	Titanium <i>Titanio</i>	IND3ACTRNP/TIA	IND3ACTHRP/TIA	TPDH16L73	TACT16L73	SBIND3NP/PK	RACTNP	DAS_E_0021
WP Ø 4,3	Titanium <i>Titanio</i>	IND3ACTRRP/TIA	IND3ACTHRP/TIA	TPDH2L75	TACT2L73	SBIND3RP/PK	RACTRP	DAS_E_0022
Ø 5,0	Titanium <i>Titanio</i>	IND3ACTRRP/TIA	IND3ACTHRP/TIA	TPDH2L75	TACT2L73	SBIND3RP/PK	RACTRP	DAS_E_0022



Compatible with - *Compatible con* ALPHABIO

External Alphabio *Alphabio Externo* - ALPHABIO



Platform		Non-Engaging	Engaging	Dynamic screw	Straight screw	Scanbody	Analog	Library code
Plataforma		Rotatorio	No Rotatorio	Tornillo Dinámico	Tornillo recto	Scanbody	Réplica	Código biblioteca
NP	Titanium <i>Titanio</i>	IND3UCS35/TIA	IND3UCH35/TIA	TPDH16L6	TBRA16L70	SBIND3NP/PK	RUC35	DAS_E_0023
RP	Titanium <i>Titanio</i>	IND3UCS41/TIA	IND3UCH41/TIA	TPDH2L6	TBRA2L70	SBIND3RP/PK	RUC41	DAS_E_0024



	Hex.	h.
NP	2,40	0,70
RP	2,70	0,70

Internal Alphabio *Alphabio Interno* - ALPHABIO



NP	Titanium <i>Titanio</i>	IND3ZIMR35/TIA	IND3ZIMH35/TIA	TPDH17L71	TZIML76	SBIND3NP/PK	RZIM35	DAS_E_0040
RP	Titanium <i>Titanio</i>	IND3ZIMR35/TIA	IND3ZIMH35/TIA	TPDH17L71	TZIML76	SBIND3NP/PK	RZIM35	DAS_E_0040
WP	Titanium <i>Titanio</i>	IND3ZIMR35/TIA	IND3ZIMH35/TIA	TPDH17L71	TZIML76	SBIND3NP/PK	RZIM35	DAS_E_0040



Compatible with - *Compatible con* ANCLADEN

Anclalock - ANCLADEN



Platform	Non-Engaging	Engaging	Dynamic screw	Straight screw	Scanbody	Analog	Library code
Plataforma	Rotatorio	No Rotatorio	Tornillo Dinámico	Tornillo recto	Scanbody	Réplica	Código biblioteca
∅ 3,75 Titanium Titanio	IND3ZIMR35/TIA	IND3ZIMH35/TIA	TPDH17L71	TZIML76	SBIND3NP/PK	RZIM35	DAS_E_0040
∅ 4,25 Titanium Titanio	IND3ZIMR35/TIA	IND3ZIMH35/TIA	TPDH17L71	TZIML76	SBIND3NP/PK	RZIM35	DAS_E_0040
∅ 5 Titanium Titanio	IND3ZIMR35/TIA	IND3ZIMH35/TIA	TPDH17L71	TZIML76	SBIND3NP/PK	RZIM35	DAS_E_0040



Compatible with - *Compatible con* ANTHOGR

Anthofit HE - ANTHOGR



Platform	Non-Engaging	Engaging	Dynamic screw	Straight screw	Scanbody	Analog	Library code
Plataforma	Rotatorio	No Rotatorio	Tornillo Dinámico	Tornillo recto	Scanbody	Réplica	Código biblioteca
RP Titanium Titanio	IND3UCS41/TIA	IND3UCH41/TIA	TPDH2L65	TBRA2L70	SBIND3RP/PK	RUC41	DAS_E_0024



	Hex.	h.
RP	2,70	0,70

Ossfit - ANTHOGR



∅ 4,8 Titanium Titanio	IND3OCR48/TIA	IND3OCO48/TIA	TPDH2L67	TSTR2L67	SBIND3OCR/PK	ROC48	DAS_E_0037
---------------------------	---------------	---------------	----------	----------	--------------	-------	------------



Compatible with - *Compatible con* ARDS

Smart - ARDS



Platform	Non-Engaging	Engaging	Dynamic screw	Straight screw	Scanbody	Analog	Library code
Plataforma	Rotatorio	No Rotatorio	Tornillo Dinámico	Tornillo recto	Scanbody	Réplica	Código biblioteca
∅ 3,75 Titanium Titanio	IND3ZIMR35/TIA	IND3ZIMH35/TIA	TPDH17L71	TZIML76	SBIND3NP/PK	RZIM35	DAS_E_0040
∅ 4,2 Titanium Titanio	IND3ZIMR35/TIA	IND3ZIMH35/TIA	TPDH17L71	TZIML76	SBIND3NP/PK	RZIM35	DAS_E_0040
∅ 4,5 Titanium Titanio	IND3ZIMR35/TIA	IND3ZIMH35/TIA	TPDH17L71	TZIML76	SBIND3NP/PK	RZIM35	DAS_E_0040



Compatible with - *Compatible con* ARDS

Classic - ARDS



Platform		Non-Engaging	Engaging	Dynamic screw	Straight screw	Scanbody	Analog	Library code
<i>Plataforma</i>		<i>Rotatorio</i>	<i>No Rotatorio</i>	<i>Tornillo Dinámico</i>	<i>Tornillo recto</i>	<i>Scanbody</i>	<i>Réplica</i>	<i>Código biblioteca</i>
Ø 3,3	Titanium <i>Titanio</i>	IND3ZIMR35/TIA	IND3ZIMH35/TIA	TPDH17L71	TZIML76	SBIND3NP/PK	RZIM35	DAS_E_0040
Ø 3,75	Titanium <i>Titanio</i>	IND3ZIMR35/TIA	IND3ZIMH35/TIA	TPDH17L71	TZIML76	SBIND3NP/PK	RZIM35	DAS_E_0040
Ø 4,2	Titanium <i>Titanio</i>	IND3ZIMR35/TIA	IND3ZIMH35/TIA	TPDH17L71	TZIML76	SBIND3NP/PK	RZIM35	DAS_E_0040
Ø 5	Titanium <i>Titanio</i>	IND3ZIMR35/TIA	IND3ZIMH35/TIA	TPDH17L71	TZIML76	SBIND3NP/PK	RZIM35	DAS_E_0040
Ø 6	Titanium <i>Titanio</i>	IND3ZIMR35/TIA	IND3ZIMH35/TIA	TPDH17L71	TZIML76	SBIND3NP/PK	RZIM35	DAS_E_0040



Premium - ARDS



Ø 3,3	Titanium <i>Titanio</i>	IND3ZIMR35/TIA	IND3ZIMH35/TIA	TPDH17L71	TZIML76	SBIND3NP/PK	RZIM35	DAS_E_0040
Ø 3,75	Titanium <i>Titanio</i>	IND3ZIMR35/TIA	IND3ZIMH35/TIA	TPDH17L71	TZIML76	SBIND3NP/PK	RZIM35	DAS_E_0040
Ø 4,2	Titanium <i>Titanio</i>	IND3ZIMR35/TIA	IND3ZIMH35/TIA	TPDH17L71	TZIML76	SBIND3NP/PK	RZIM35	DAS_E_0040
Ø 5	Titanium <i>Titanio</i>	IND3ZIMR35/TIA	IND3ZIMH35/TIA	TPDH17L71	TZIML76	SBIND3NP/PK	RZIM35	DAS_E_0040
Ø 6	Titanium <i>Titanio</i>	IND3ZIMR35/TIA	IND3ZIMH35/TIA	TPDH17L71	TZIML76	SBIND3NP/PK	RZIM35	DAS_E_0040



Compatible with - *Compatible con* ASTRA

Aqua - ASTRA



Platform		Non-Engaging	Engaging	Dynamic screw	Straight screw	Scanbody	Analog	Library code
<i>Plataforma</i>		<i>Rotatorio</i>	<i>No Rotatorio</i>	<i>Tornillo Dinámico</i>	<i>Tornillo recto</i>	<i>Scanbody</i>	<i>Réplica</i>	<i>Código biblioteca</i>
RP	Titanium <i>Titanio</i>	IND3ASTRRP/TIA	IND3ASTHRP/TIA	TPDH16L76	TAST16L82	SBIND3RP/PK	RASTRP	DAS_E_0004



Lilac - ASTRA



WP	Titanium <i>Titanio</i>	IND3ASTRWP/TIA	IND3ASTHWP/TIA	TPDH2L90	TAST2L103	SBIND3RP/PK	RASTRP	DAS_E_0005
----	----------------------------	----------------	----------------	----------	-----------	-------------	--------	------------



Compatible with - *Compatible con* ASTRA

Uni Abutment - ASTRA



Platform	Non-Engaging	Engaging	Dynamic screw	Straight screw	Scanbody	Analog	Library code
Plataforma	Rotatorio	No Rotatorio	Tornillo Dinámico	Tornillo recto	Scanbody	Réplica	Código biblioteca
RP Titanium Titanio	IND3AEVUA/TIA	---	TPDH18L45	TEV18L45	SBIND3NP/PK	---	DAS_E_0008



Evolution - ASTRA



Ø 3,6 Titanium Titanio	IND3AEVR36/TIA	IND3AEVH36/TIA	TPDH16L72	TEV16L75	SBIND3NP/PK	---	DAS_E_0006
Ø 4,2 Titanium Titanio	IND3AEVR42/TIA	IND3AEVH42/TIA	TPDH18L74	TEV18L76	SBIND3RP/PK	---	DAS_E_0007



Compatible with - *Compatible con* AVINENT

HE - AVINENT



Platform	Non-Engaging	Engaging	Dynamic screw	Straight screw	Scanbody	Analog	Library code
Plataforma	Rotatorio	No Rotatorio	Tornillo Dinámico	Tornillo recto	Scanbody	Réplica	Código biblioteca
NP Titanium Titanio	IND3UCS35/TIA	IND3UCH35/TIA	TPDH18	---	SBIND3NP/PK	---	DAS_E_0023
RP Titanium Titanio	IND3UCS41/TIA	IND3UCH41/TIA	TPDH2L6	TBRA2L70	SBIND3RP/PK	RUC41	DAS_E_0024



	Hex.	h.
RP	2,70	0,70

HI - AVINENT



Ø 3,5 Titanium Titanio	IND3ZIMR35/TIA	IND3ZIMH35/TIA	TPDH17L71	TZIML76	SBIND3NP/PK	RZIM35	DAS_E_0040
Ø 4,1 Titanium Titanio	IND3ZIMR35/TIA	IND3ZIMH35/TIA	TPDH17L71	TZIML76	SBIND3NP/PK	RZIM35	DAS_E_0040



Transepitelial - AVINENT



RP Titanium Titanio	IND3CO41/TIA	---	TPDH14L39	TMU14L35	SBIND3MURP/PK	RMU48	DAS_E_0025
------------------------	--------------	-----	-----------	----------	---------------	-------	------------



Compatible with - *Compatible con* BIOGENESIS

3Icon - BIOGENESIS



Platform	Non-Engaging	Engaging	Dynamic screw	Straight screw	Scanbody	Analog	Library code
Plataforma	Rotatorio	No Rotatorio	Tornillo Dinámico	Tornillo recto	Scanbody	Réplica	Código biblioteca
NP Titanium Titanio	IND3UCS35/TIA	IND3UCH35/TIA	TPDH16L6	TBRA16L70	SBIND3NP/PK	RUC35	DAS_E_0023
RP Titanium Titanio	IND3UCS41/TIA	IND3UCH41/TIA	TPDH2L6	TBRA2L70	SBIND3RP/PK	RUC41	DAS_E_0024



	Hex.	h.
NP	2,40	0,70
RP	2,70	0,70

Aticon - BIOGENESIS



WP Titanium Titanio	IND3ASTRWP/TIA	IND3ASTHWP/TIA	TPDH2L90	TAST2L103	SBIND3RP/PK	RASTWP	DAS_E_0005
------------------------	----------------	----------------	----------	-----------	-------------	--------	------------



Iticon - BIOGENESIS



RP Titanium Titanio	IND3OCR48/TIA	IND3OCO48/TIA	TPDH2L67	TSTR2L67	SBIND3OCR/PK	ROC48	DAS_E_0037
------------------------	---------------	---------------	----------	----------	--------------	-------	------------



Compatible with - *Compatible con* BIOHORIZON

Internal *Interno* - BIOHORIZON



Platform	Non-Engaging	Engaging	Dynamic screw	Straight screw	Scanbody	Analog	Library code
Plataforma	Rotatorio	No Rotatorio	Tornillo Dinámico	Tornillo recto	Scanbody	Réplica	Código biblioteca
NP Titanium Titanio	IND3ZIMR35/TIA	IND3ZIMH35/TIA	TPDH17L71	TZIML76	SBIND3NP/PK	RZIM35	DAS_E_0040
RP Titanium Titanio	IND3ZIMR45/TIA	IND3ZIMH45/TIA	TPDH17L71	TZIML76	SBIND3RP/PK	RZIM45	DAS_E_0041



Compatible with - *Compatible con* BIOMET 3i

Osseotite - BIOMET 3i



Platform		Non-Engaging	Engaging	Dynamic screw	Straight screw	Scanbody	Analog	Library code
Plataforma		Rotatorio	No Rotatorio	Tornillo Dinámico	Tornillo recto	Scanbody	Réplica	Código biblioteca
NP	Titanium Titanio	IND3UCS33/TIA	IND3UCH33/TIA	TPDH2L65	T3I2L70	SBIND3NP/PK	RUC33	DAS_E_0003
RP	Titanium Titanio	IND3UCS41/TIA	IND3UCH41/TIA	TPDH2L6	T3I2L70	SBIND3RP/PK	RUC41	DAS_E_0024



	Hex.	h.
NP	2,55	0,70
RP	2,70	0,70

Certain - BIOMET 3i



NP	Titanium Titanio	IND3IRNP/TIA	IND3IHNP/TIA	TPDH16L84	T3I16L84	SBIND3NP/PK	R3IINT34	DAS_E_0001
RP	Titanium Titanio	IND3IRRP/TIA	IND3IHRP/TIA	TPDH16L84	T3I16L84	SBIND3RP/PK	R3IINT40	DAS_E_0002



Compatible with - *Compatible con* BIOLOK

External Hexagon *Hexágono Externo* - BIOLOK



Platform		Non-Engaging	Engaging	Dynamic screw	Straight screw	Scanbody	Analog	Library code
Plataforma		Rotatorio	No Rotatorio	Tornillo Dinámico	Tornillo recto	Scanbody	Réplica	Código biblioteca
NP	Titanium Titanio	IND3UCS33/TIA	IND3UCH33/TIA	TPDH2L65	T3I2L70	SBIND3NP/PK	RUC33	DAS_E_0003



	Hex.	h.
NP	2,55	0,70

Compatible with - *Compatible con* BIONER

Ikelt/Bikelt - BIONER



Platform		Non-Engaging	Engaging	Dynamic screw	Straight screw	Scanbody	Analog	Library code
Plataforma		Rotatorio	No Rotatorio	Tornillo Dinámico	Tornillo recto	Scanbody	Réplica	Código biblioteca
RP	Titanium Titanio	IND3UCS41/TIA	IND3UCH41/TIA	TPDH2L6	TBRA2L70	SBIND3RP/PK	RUC41	DAS_E_0024



	Hex.	h.
RP	2,70	0,70

Compatible with - *Compatible con* BIONER

Hikelt - BIONER



Platform		Non-Engaging	Engaging	Dynamic screw	Straight screw	Scanbody	Analog	Library code
Plataforma		Rotatorio	No Rotatorio	Tornillo Dinámico	Tornillo recto	Scanbody	Réplica	Código biblioteca
RP	Titanium	IND3ZIMR35/TIA	IND3ZIMH35/TIA	TPDH17L71	TZIML76	SBIND3NP/PK	RZIM35	DAS_E_0040
Ø 3,8	Titanio							
RP	Titanium	IND3ZIMR45/TIA	IND3ZIMH45/TIA	TPDH17L71	TZIML76	SBIND3RP/PK	RZIM45	DAS_E_0041
Ø 4,7	Titanio							



TopDM - BIONER



Ø 3,5	Titanium	IND3ACTRNP/TIA	IND3ACTHNP/TIA	TPDH16L73	TACT16L73	SBIND3NP/PK	RACTNP	DAS_E_0021
	Titanio							
Ø 4	Titanium	IND3ACTRNP/TIA	IND3ACTHNP/TIA	TPDH16L73	TACT16L73	SBIND3NP/PK	RACTNP	DAS_E_0021
	Titanio							
Ø 5	Titanium	IND3ACTRNP/TIA	IND3ACTHNP/TIA	TPDH16L73	TACT16L73	SBIND3NP/PK	RACTNP	DAS_E_0021
	Titanio							



Multi-Unit - BIONER



RP	Titanium	IND3CO41/TIA	---	TPDH14L39	TMU14L35	SBIND3MURP/PK	RMU48	DAS_E_0025
	Titanio							



Compatible with - *Compatible con* BTI

External Connection *Conexión Externa* - BTI



Platform		Non-Engaging	Engaging	Dynamic screw	Straight screw	Scanbody	Analog	Library code
Plataforma		Rotatorio	No Rotatorio	Tornillo Dinámico	Tornillo recto	Scanbody	Réplica	Código biblioteca
TINY	Titanium	IND3UCS35BT/TIA	IND3UCH35BT/TIA	TPDH2L51	---	SBIND3NP/PK	RUC35BT	DAS_E_0009
	Titanio							
RP	Titanium	IND3UCS41/TIA	IND3UCH41/TIA	TPDH2L6	T312L70	SBIND3RP/PK	RUC41	DAS_E_0024
	Titanio							



	Hex.	h.
TINY	2,50	1,10
RP	2,70	0,70

Internal Connection *Conexión Interna* - BTI



RP	Titanium	IND3BTIRRP/TIA	IND3BTIHRP/TIA	TPDH18L65	TBT118L68	SBIND3RP/PK	RBT41	DAS_E_0010
	Titanio							



Compatible with - *Compatible con* BTK

Klassic/Konic - BTK



Platform		Non-Engaging	Engaging	Dynamic screw	Straight screw	Scanbody	Analog	Library code
Plataforma		Rotatorio	No Rotatorio	Tornillo Dinámico	Tornillo recto	Scanbody	Réplica	Código biblioteca
NP	Titanium Titanio	IND3UCS33/TIA	IND3UCH33/TIA	TPDH18L65	TBT118L68	SBIND3NP/PK	---	DAS_E_0003
RP	Titanium Titanio	IND3UCS41/TIA	IND3UCH41/TIA	TPDH2L6	TBRA2L70	SBIND3RP/PK	RUC41	DAS_E_0024



Compatible with - *Compatible con* B&W

External Connection *Conexión Externa* - B&W



Platform		Non-Engaging	Engaging	Dynamic screw	Straight screw	Scanbody	Analog	Library code
Plataforma		Rotatorio	No Rotatorio	Tornillo Dinámico	Tornillo recto	Scanbody	Réplica	Código biblioteca
RP	Titanium Titanio	IND3UCS41/TIA	IND3UCH41/TIA	TPDH2L6	TBRA2L70	SBIND3RP/PK	RUC41	DAS_E_0024



Compatible with - *Compatible con* CAMLOG

Screw-Line - CAMLOG

*Maxim angulation 20°
*Angulación máxima 20°



Platform		Non-Engaging	Engaging	Dynamic screw	Straight screw	Scanbody	Analog	Library code
Plataforma		Rotatorio	No Rotatorio	Tornillo Dinámico	Tornillo recto	Scanbody	Réplica	Código biblioteca
∅ 3,8*	Titanium Titanio	IND3CAMR38/TIA	IND3CAMH38/TIA	TPDH16L94	TCAM16L105	SBIND3NP/PK	---	DAS_E_0011
∅ 4,3*	Titanium Titanio	IND3CAMR43/TIA	IND3CAMH43/TIA	TPDH16L94	TCAM16L105	SBIND3RP/PK	---	DAS_E_0012

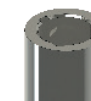

Compatible with - *Compatible con* CONEXÃO SISTEMA DE PRÓTESE

AR-Morse - CONEXÃO SISTEMA DE PRÓTESE



Platform		Non-Engaging	Engaging	Dynamic screw	Straight screw	Scanbody		Library code
Plataforma		Rotatorio	No Rotatorio	Tornillo Dinámico	Tornillo recto	Scanbody		Código biblioteca
∅ 3,75	Titanium Titanio	IND3ACTRNP/TIA	IND3ACTHNP/TIA	TPDH16L73	TACT16L73	SBIND3NP/PK	RACTNP	DAS_E_0021
∅ 4	Titanium Titanio	IND3ACTRNP/TIA	IND3ACTHNP/TIA	TPDH16L73	TACT16L73	SBIND3NP/PK	RACTNP	DAS_E_0021



Compatible with - *Compatible con* CORTEX

Dynamix - CORTEX



Platform	Non-Engaging	Engaging	Dynamic screw	Straight screw	Scanbody	Analog	Library code
<i>Plataforma</i>	<i>Rotatorio</i>	<i>No Rotatorio</i>	<i>Tornillo Dinámico</i>	<i>Tornillo recto</i>	<i>Scanbody</i>	<i>Réplica</i>	<i>Código biblioteca</i>
∅ 4,2 Titanium <i>Titano</i>	IND3ZIMR35/TIA	IND3ZIMH35/TIA	TPDH17L71	TZIML76	SBIND3NP/PK	RZIM35	DAS_E_0040



Classix - CORTEX



∅ 4,2 Titanium <i>Titano</i>	IND3ZIMR35/TIA	IND3ZIMH35/TIA	TPDH17L71	TZIML76	SBIND3NP/PK	RZIM35	DAS_E_0040
---------------------------------	----------------	----------------	-----------	---------	-------------	--------	------------



Saturn - CORTEX



∅ 4,2 Titanium <i>Titano</i>	IND3ZIMR35/TIA	IND3ZIMH35/TIA	TPDH17L71	TZIML76	SBIND3NP/PK	RZIM35	DAS_E_0040
---------------------------------	----------------	----------------	-----------	---------	-------------	--------	------------



Compatible with - *Compatible con* DENTALTECH

Implogic - DENTALTECH



Platform	Non-Engaging	Engaging	Dynamic screw	Straight screw	Scanbody	Analog	Library code
<i>Plataforma</i>	<i>Rotatorio</i>	<i>No Rotatorio</i>	<i>Tornillo Dinámico</i>	<i>Tornillo recto</i>	<i>Scanbody</i>	<i>Réplica</i>	<i>Código biblioteca</i>
∅ 4,5 Titanium <i>Titano</i>	IND3ZIMR45/TIA	IND3ZIMH45/TIA	TPDH17L71	TZIML76	SBIND3RP/PK	RZIM45	DAS_E_0041



Compatible with - *Compatible con* DENTIS

S-Clean - DENTIS

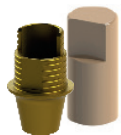

Platform	Non-Engaging	Engaging	Dynamic screw	Straight screw	Scanbody	Analog	Library code	
<i>Plataforma</i>	<i>Rotatorio</i>	<i>No Rotatorio</i>	<i>Tornillo Dinámico</i>	<i>Tornillo recto</i>	<i>Scanbody</i>	<i>Réplica</i>	<i>Código biblioteca</i>	
MINI RP WP	Titanium Titanio	IND3OTSRRP/TIA	IND3OTSHRP/TIA	TPDH2L79	---	SBIND3RP/PK	---	DAS_E_0030



Compatible with - *Compatible con* DENTIUM

SuperLine and Implantium - DENTIUM

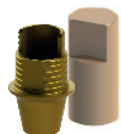

Platform	Non-Engaging	Engaging	Dynamic screw	Straight screw	Scanbody	Analog	Library code	
<i>Plataforma</i>	<i>Rotatorio</i>	<i>No Rotatorio</i>	<i>Tornillo Dinámico</i>	<i>Tornillo recto</i>	<i>Scanbody</i>	<i>Réplica</i>	<i>Código biblioteca</i>	
Ø3,6	Titanium Titanio	IND3OTSRRP/TIA	IND3OTSHRP/TIA	TPDH2L79	---	SBIND3RP/PK	---	DAS_E_0030
Ø4	Titanium Titanio	IND3OTSRRP/TIA	IND3OTSHRP/TIA	TPDH2L79	---	SBIND3RP/PK	---	DAS_E_0030
Ø4,5	Titanium Titanio	IND3OTSRRP/TIA	IND3OTSHRP/TIA	TPDH2L79	---	SBIND3RP/PK	---	DAS_E_0030
Ø5	Titanium Titanio	IND3OTSRRP/TIA	IND3OTSHRP/TIA	TPDH2L79	---	SBIND3RP/PK	---	DAS_E_0030
Ø6	Titanium Titanio	IND3OTSRRP/TIA	IND3OTSHRP/TIA	TPDH2L79	---	SBIND3RP/PK	---	DAS_E_0030



Simpleline II - DENTIUM



Ø 4,8	Titanium Titanio	IND3OCR48/TIA	IND3OCO48/TIA	TPDH2L67	TSTR2L67	SBIND3OCR/PK	---	DAS_E_0037
-------	---------------------	---------------	---------------	----------	----------	--------------	-----	------------



Compatible with - *Compatible con* DIO IMPLANTS

SM System - DIO IMPLANTS



Platform	Non-Engaging	Engaging	Dynamic screw	Straight screw	Scanbody	Analog	Library code	
<i>Plataforma</i>	<i>Rotatorio</i>	<i>No Rotatorio</i>	<i>Tornillo Dinámico</i>	<i>Tornillo recto</i>	<i>Scanbody</i>	<i>Réplica</i>	<i>Código biblioteca</i>	
RP WP	Titanium Titanio	IND3DIORRP/TIA	IND3DIOHRP/TIA	TPDH2L74	TDSM2L74	SBIND3RP/PK	---	DAS_E_0013



Compatible with - *Compatible con* DIO IMPLANTS

UF II Narrow - DIO IMPLANTS



Platform		Non-Engaging	Engaging	Dynamic screw	Straight screw	Scanbody	Analog	Library code
Plataforma		Rotatorio	No Rotatorio	Tornillo Dinámico	Tornillo recto	Scanbody	Réplica	Código biblioteca
NP	Titanium Titanio	IND3DUFNRP/TIA	IND3DUFHNP/TIA	TPDH14L67	---	SBIND3NP/PK	---	DAS_E_0014



UF II - DIO IMPLANTS



	Ø 3,8 Ø 4 Ø 4,5 Ø 5 Ø 5,5	Titanium Titanio	IND3OTSRRP/TIA	IND3OTSHRP/TIA	TPDH2L79	---	SBIND3RP/PK	---	DAS_E_0030
--	---------------------------------------	---------------------	----------------	----------------	----------	-----	-------------	-----	------------



External *Externo* - DIO IMPLANTS



NP	Titanium Titanio	IND3UCS35/TIA	IND3UCH35/TIA	TPDH16L6	TBRA16L70	SBIND3NP/PK	RUC35	DAS_E_0023
RP	Titanium Titanio	IND3UCS41/TIA	IND3UCH41/TIA	TPDH2L6	TBRA2L70	SBIND3RP/PK	RUC41	DAS_E_0024



	Hex.	h.
NP	2,40	0,70
RP	2,70	0,70

Compatible with - *Compatible con* DSP BIOMEDICAL

External Hexagon *Hexágono Externo* - DSP BIOMEDICAL



Platform		Non-Engaging	Engaging	Dynamic screw	Straight screw	Scanbody	Analog	Library code
Plataforma		Rotatorio	No Rotatorio	Tornillo Dinámico	Tornillo recto	Scanbody	Réplica	Código biblioteca
RP	Titanium Titanio	IND3UCS41/TIA	IND3UCH41/TIA	TPDH2L65	TBRA2L70	SBIND3RP/PK	RUC41	DAS_E_0024



	Hex.	h.
RP	2,70	0,70

Compatible with - *Compatible con* ELITE MEDICAL

External Connection *Conexión Externa* - ELITE MEDICAL



Platform		Non-Engaging	Engaging	Dynamic screw	Straight screw	Scanbody	Analog	Library code
Plataforma		Rotatorio	No Rotatorio	Tornillo Dinámico	Tornillo recto	Scanbody	Réplica	Código biblioteca
NP	Titanium Titanio	IND3UCS35/TIA	IND3UCH35/TIA	TPDH16L6	TBRA16L70	SBIND3NP/PK	RUC35	DAS_E_0023
RP	Titanium Titanio	IND3UCS41/TIA	IND3UCH41/TIA	TPDH2L6	TBRA2L70	SBIND3RP/PK	RUC41	DAS_E_0024



	Hex.	h.
NP	2,40	0,70
RP	2,70	0,70

Naturactis - EUROTEKNIKA

Platform		Non-Engaging	Engaging	Dynamic screw	Straight screw	Scanbody	Analog	Library code
Plataforma		Rotatorio	No Rotatorio	Tornillo Dinámico	Tornillo recto	Scanbody	Réplica	Código biblioteca
Ø3,5	Titanium Titanio	IND3ASTRRP/TIA	IND3ASTHRP/TIA	TPDH16L76	TAST16L82	SBIND3RP/PK	RASTRP	DAS_E_0004
Ø4	Titanium Titanio	IND3ASTRRP/TIA	IND3ASTHRP/TIA	TPDH16L76	TAST16L82	SBIND3RP/PK	RASTRP	DAS_E_0004
Ø4,5	Titanium Titanio	IND3ASTRRP/TIA	IND3ASTHRP/TIA	TPDH16L76	TAST16L82	SBIND3RP/PK	RASTRP	DAS_E_0004
Ø5	Titanium Titanio	IND3ASTRRP/TIA	IND3ASTHRP/TIA	TPDH16L76	TAST16L82	SBIND3RP/PK	RASTRP	DAS_E_0004



Uneva - EUROTEKNIKA

Ø3,6	Titanium Titanio	IND3UCS41/TIA	IND3UCH41/TIA	TPDH2L6	TBRA2L70	SBIND3RP/PK	RUC41	DAS_E_0024
Ø4,1	Titanium Titanio	IND3UCS41/TIA	IND3UCH41/TIA	TPDH2L6	TBRA2L70	SBIND3RP/PK	RUC41	DAS_E_0024



RP	Hex.	h.
	2,70	0,70

Uneva (Platform Switching) - EUROTEKNIKA

Ø4,8	Titanium Titanio	IND3UCS41/TIA	IND3UCH41/TIA	TPDH2L6	TBRA2L70	SBIND3RP/PK	---	DAS_E_0024
Ø6	Titanium Titanio	IND3UCS41/TIA	IND3UCH41/TIA	TPDH2L6	TBRA2L70	SBIND3RP/PK	---	DAS_E_0024



RP	Hex.	h.
	2,70	0,70

Natea - EUROTEKNIKA

NP	Titanium Titanio	IND3ASTRRP/TIA	IND3ASTHRP/TIA	TPDH16L76	TAST16L82	SBIND3RP/PK	RASTRP	DAS_E_0004
RP	Titanium Titanio	IND3ASTRRP/TIA	IND3ASTHRP/TIA	TPDH16L76	TAST16L82	SBIND3RP/PK	RASTRP	DAS_E_0004
WP	Titanium Titanio	IND3ASTRWP/TIA	IND3ASTHWP/TIA	TPDH2L90	TAST2L103	SBIND3RP/PK	RASTWP	DAS_E_0005



Aesthetica - EUROTEKNIKA

Ø 4,8	Titanium Titanio	IND3OCR48/TIA	IND3OCO48/TIA	TPDH2L67	TSTR2L67	SBIND3OCR/PK	ROC48	DAS_E_0037
-------	---------------------	---------------	---------------	----------	----------	--------------	-------	------------



Compatible with - *Compatible con* EUROTEKNIKA

Naturall - EUROTEKNIKA



Platform		Non-Engaging	Engaging	Dynamic screw	Straight screw	Scanbody	Analog	Library code
Plataforma		Rotatorio	No Rotatorio	Tornillo Dinámico	Tornillo recto	Scanbody	Réplica	Código biblioteca
NP	Titanium Titanio	IND3ASTRRP/TIA	IND3ASTHRP/TIA	TPDH16L76	TAST16L82	SBIND3RP/PK	RASTRP	DAS_E_0004
RP	Titanium Titanio	IND3ASTRRP/TIA	IND3ASTHRP/TIA	TPDH16L76	TAST16L82	SBIND3RP/PK	RASTRP	DAS_E_0004
WP	Titanium Titanio	IND3ASTRWP/TIA	IND3ASTHWP/TIA	TPDH2L90	TAST2L103	SBIND3RP/PK	RASTWP	DAS_E_0005



Compatible with - *Compatible con* GALIMPLANT

External Connection *Conexión Externa* - GALIMPLANT



Platform		Non-Engaging	Engaging	Dynamic screw	Straight screw	Scanbody	Analog	Library code
Plataforma		Rotatorio	No Rotatorio	Tornillo Dinámico	Tornillo recto	Scanbody	Réplica	Código biblioteca
RP	Titanium Titanio	IND3UCS41/TIA	IND3UCH41/TIA	TPDH2L65	TBRA2L70	SBIND3RP/PK	RUC41	DAS_E_0024



	Hex.	h.
RP	2,70	0,70

Internal Connection *Conexión Interna* - GALIMPLANT



RP	Titanium Titanio	IND3ASTRRP/TIA	IND3ASTHRP/TIA	TPDH16L76	TAST16L82	SBIND3RP/PK	RASTRP	DAS_E_0004
----	---------------------	----------------	----------------	-----------	-----------	-------------	--------	------------



Compatible with - *Compatible con* GMI

Phoenix - GMI



Platform		Non-Engaging	Engaging	Dynamic screw	Straight screw	Scanbody	Analog	Library code
Plataforma		Rotatorio	No Rotatorio	Tornillo Dinámico	Tornillo recto	Scanbody	Réplica	Código biblioteca
RP	Titanium Titanio	IND3UCS41/TIA	IND3UCH41/TIA	TPDH2L6	TBRA2L70	SBIND3RP/PK	RUC41	DAS_E_0024



	Hex.	h.
RP	2,70	0,70

Compatible with - *Compatible con* GMI

Frontier - GMI



Platform		Non-Engaging	Engaging	Dynamic screw	Straight screw	Scanbody	Analog	Library code
Plataforma		Rotatorio	No Rotatorio	Tornillo Dinámico	Tornillo recto	Scanbody	Réplica	Código biblioteca
STANDARD	Titanium Titanio	IND3ZIMR35/TIA	IND3ZIMH35/TIA	TPDH18L75	---	SBIND3NP/PK	---	DAS_E_0040
WP	Titanium Titanio	IND3ZIMR45/TIA	IND3ZIMH45/TIA	TPDH18L75	---	SBIND3RP/PK	---	DAS_E_0041



Compatible with - *Compatible con* GT MEDICAL

Best Fit Internal Octagon *Best Fit Octógono Interno* - GT MEDICAL



Platform		Non-Engaging	Engaging	Dynamic screw	Straight screw	Scanbody	Analog	Library code
Plataforma		Rotatorio	No Rotatorio	Tornillo Dinámico	Tornillo recto	Scanbody	Réplica	Código biblioteca
RP	Titanium Titanio	IND3OCR48/TIA	IND3OCO48/TIA	TPDH2L67	TSTR2L67	SBIND3OCR/PK	ROC48	DAS_E_0037



Best Fit Internal Hexagon *Best Fit Hexágono Interno* - GT MEDICAL



WP	Titanium Titanio	IND3ASTRWP/TIA	IND3ASTHWP/TIA	TPDH2L90	TAST2L103	SBIND3RP/PK	---	DAS_E_0005
----	---------------------	----------------	----------------	----------	-----------	-------------	-----	------------



Best Fit External Hexagon *Best Fit Hexágono Externo* - GT MEDICAL



NP	Titanium Titanio	IND3UCS35/TIA	IND3UCH35/TIA	TPDH16L6	TBRA16L70	SBIND3NP/PK	RUC35	DAS_E_0023
RP	Titanium Titanio	IND3UCS41/TIA	IND3UCH41/TIA	TPDH2L6	TBRA2L70	SBIND3RP/PK	RUC41	DAS_E_0024



	Hex.	h.
NP	2,40	0,70
RP	2,70	0,70

Compatible with - *Compatible con* HI-TECH

Self Thread SLT - HI-TECH



Platform	Non-Engaging	Engaging	Dynamic screw	Straight screw	Scanbody	Analog	Library code
<i>Plataforma</i>	<i>Rotatorio</i>	<i>No Rotatorio</i>	<i>Tornillo Dinámico</i>	<i>Tornillo recto</i>	<i>Scanbody</i>	<i>Réplica</i>	<i>Código biblioteca</i>
Ø3,75 Titanium <i>Titanio</i>	IND3ZIMR35/TIA	IND3ZIMH35/TIA	TPDH17L71	TZIML76	SBIND3NP/PK	RZIM35	DAS_E_0040



Self Thread GTI - HI-TECH



Ø 4,2 Titanium <i>Titanio</i>	IND3ZIMR45/TIA	IND3ZIMH45/TIA	TPDH17L71	TZIML76	SBIND3RP/PK	RZIM45	DAS_E_0041
----------------------------------	----------------	----------------	-----------	---------	-------------	--------	------------



LGI Plus - HI-TECH



Ø4,3 Titanium <i>Titanio</i>	IND3ZIMR35/TIA	IND3ZIMH35/TIA	TPDH17L71	TZIML76	SBIND3NP/PK	RZIM35	DAS_E_0040
---------------------------------	----------------	----------------	-----------	---------	-------------	--------	------------



Compatible with - *Compatible con* IMBIODENT

Imbiotent - IMBIODENT



Platform	Non-Engaging	Engaging	Dynamic screw	Straight screw	Scanbody	Analog	Library code
<i>Plataforma</i>	<i>Rotatorio</i>	<i>No Rotatorio</i>	<i>Tornillo Dinámico</i>	<i>Tornillo recto</i>	<i>Scanbody</i>	<i>Réplica</i>	<i>Código biblioteca</i>
NP Titanium <i>Titanio</i>	IND3BONRNP/TIA	IND3BONHNP/TIA	TPDH16L78	TBON16L79	SBIND3NP/PK	RBONNP	DAS_E_0033
RP Titanium <i>Titanio</i>	IND3BONRRP/TIA	IND3BONHRP/TIA	TPDH16L78	TBON16L79	SBIND3RP/PK	RBONRP	DAS_E_0035



Compatible with - *Compatible con* IMPLANT DIRECT

Replus-Replant-Reactive - IMPLANT DIRECT



Platform		Non-Engaging	Engaging	Dynamic screw	Straight screw	Scanbody	Analog	Library code
<i>Plataforma</i>		<i>Rotatorio</i>	<i>No Rotatorio</i>	<i>Tornillo Dinámico</i>	<i>Tornillo recto</i>	<i>Scanbody</i>	<i>Réplica</i>	<i>Código biblioteca</i>
NP	Titanium <i>Titano</i>	IND3RPLR35/TIA	IND3RPLT35/TIA	TPDH18L75	TRPL18L83	SBIND3NP/PK	---	DAS_E_0026
RP	Titanium <i>Titano</i>	IND3RPLR43/TIA	IND3RPLT43/TIA	TPDH2L90	TRPL2L100	SBIND3RP/PK	---	DAS_E_0027
WP	Titanium <i>Titano</i>	IND3RPLR50/TIA	IND3RPLT50/TIA	TPDH2L90	TRPL2L100	SBIND3RP/PK	---	DAS_E_0028

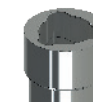

Legacy - IMPLANT DIRECT



NP	Titanium <i>Titano</i>	IND3ZIMR35/TIA	IND3ZIMH35/TIA	TPDH17L71	TZIML76	SBIND3NP/PK	RZIM35	DAS_E_0040
RP	Titanium <i>Titano</i>	IND3ZIMR45/TIA	IND3ZIMH45/TIA	TPDH17L71	TZIML76	SBIND3RP/PK	RZIM45	DAS_E_0041



Swishplant / Swishplus - IMPLANT DIRECT



RP	Titanium <i>Titano</i>	IND3OCR48/TIA	IND3OCO48/TIA	TPDH2L67	TSTR2L67	SBIND3OCR/PK	ROC48	DAS_E_0037
----	---------------------------	---------------	---------------	----------	----------	--------------	-------	------------



Interactive - IMPLANT DIRECT



NP	Titanium <i>Titano</i>	IND3ACTRNP/TIA	IND3ACTHNP/TIA	TPDH16L73	TACT16L73	SBIND3NP/PK	RACTNP	DAS_E_0021
RP	Titanium <i>Titano</i>	IND3ACTRRP/TIA	IND3ACTHRP/TIA	TPDH2L75	TACT2L73	SBIND3RP/PK	RACTRP	DAS_E_0022



Compatible with - *Compatible con* JDENTALCARE

JDEvolution - JDENTALCARE



Platform		Non-Engaging	Engaging	Dynamic screw	Straight screw	Scanbody	Analog	Library code
Plataforma		Rotatorio	No Rotatorio	Tornillo Dinámico	Tornillo recto	Scanbody	Réplica	Código biblioteca
Ø 3,7	Titanium Titanio	IND3ZIMR35/TIA	IND3ZIMH35/TIA	TPDH17L71	TZIML76	SBIND3NP/PK	RZIM35	DAS_E_0040
Ø 4,3	Titanium Titanio	IND3ZIMR35/TIA	IND3ZIMH35/TIA	TPDH17L71	TZIML76	SBIND3NP/PK	RZIM35	DAS_E_0040
Ø 5	Titanium Titanio	IND3ZIMR35/TIA	IND3ZIMH35/TIA	TPDH17L71	TZIML76	SBIND3NP/PK	RZIM35	DAS_E_0040
Ø 6	Titanium Titanio	IND3ZIMR35/TIA	IND3ZIMH35/TIA	TPDH17L71	TZIML76	SBIND3NP/PK	RZIM35	DAS_E_0040



Compatible with - *Compatible con* KEYSTONE

Restore - KEYSTONE



Platform		Non-Engaging	Engaging	Dynamic screw	Straight screw	Scanbody	Analog	Library code
Plataforma		Rotatorio	No Rotatorio	Tornillo Dinámico	Tornillo recto	Scanbody	Réplica	Código biblioteca
RP	Titanium Titanio	IND3UCS41/TIA	IND3UCH41/TIA	TPDH2L6	TBRA2L70	SBIND3RP/PK	RUC41	DAS_E_0024



	Hex.	h.
RP	2,70	0,70

Compatible with - *Compatible con* KLOCKNER

KL - KLOCKNER



Platform		Non-Engaging	Engaging	Dynamic screw	Straight screw	Scanbody	Analog	Library code
Plataforma		Rotatorio	No Rotatorio	Tornillo Dinámico	Tornillo recto	Scanbody	Réplica	Código biblioteca
NP	Titanium Titanio	IND3UCS35/TIA	IND3UCH35/TIA	TPDH16L6	TBRA16L70	SBIND3NP/PK	RUC35	DAS_E_0023
RP	Titanium Titanio	IND3UCS41/TIA	IND3UCH41/TIA	TPDH2L6	T3I2L70	SBIND3RP/PK	RUC41	DAS_E_0024



	Hex.	h.
NP	2,40	0,70
RP	2,70	0,70

Compatible with - *Compatible con* LEADER

Tixos Internal Hexagon *Tixos Hexágono Interno* - LEADER



Platform	Non-Engaging	Engaging	Dynamic screw	Straight screw	Scanbody	Analog	Library code
<i>Plataforma</i>	<i>Rotatorio</i>	<i>No Rotatorio</i>	<i>Tornillo Dinámico</i>	<i>Tornillo recto</i>	<i>Scanbody</i>	<i>Réplica</i>	<i>Código biblioteca</i>
Ø 3,5 Titanium <i>Titanio</i>	IND3ZIMR35/TIA	IND3ZIMH35/TIA	TPDH17L71	TZIML76	SBIND3NP/PK	RZIM35	DAS_E_0040
Ø 4 Titanium <i>Titanio</i>	IND3ZIMR35/TIA	IND3ZIMH35/TIA	TPDH17L71	TZIML76	SBIND3NP/PK	RZIM35	DAS_E_0040



Tixos External Hexagon *Tixos Hexágono Externo* - LEADER



Ø 4,1 Titanium <i>Titanio</i>	IND3UCS41/TIA	IND3UCH41/TIA	TPDH2L6	TBRA2L70	SBIND3RP/PK	RUC41	DAS_E_0024
-------------------------------------	---------------	---------------	---------	----------	-------------	-------	------------



	Hex.	h.
RP	2,70	0,70

Compatible with - *Compatible con* MEGAGEN

AnyRidge - MEGAGEN



Platform	Non-Engaging	Engaging	Dynamic screw	Straight screw	Scanbody	Analog	Library code
<i>Plataforma</i>	<i>Rotatorio</i>	<i>No Rotatorio</i>	<i>Tornillo Dinámico</i>	<i>Tornillo recto</i>	<i>Scanbody</i>	<i>Réplica</i>	<i>Código biblioteca</i>
SMALL RP WP Titanium <i>Titanio</i>	IND3MARRRP/TIA	IND3MARHRP/TIA	TPDH18L80	---	SBIND3RP/PK	---	DAS_E_0015



AnyOne Internal *AnyOne Interno* - MEGAGEN



SMALL RP WP Titanium <i>Titanio</i>	IND3OTSRRP/TIA	IND3OTSHRP/TIA	TPDH2L79	---	SBIND3RP/PK	---	DAS_E_0030
---	----------------	----------------	----------	-----	-------------	-----	------------



Compatible with - *Compatible con* MEGAGEN

AnyOne External *AnyOne Externo* - MEGAGEN



Platform	Non-Engaging	Engaging	Dynamic screw	Straight screw	Scanbody	Analog	Library code
<i>Plataforma</i>	<i>Rotatorio</i>	<i>No Rotatorio</i>	<i>Tornillo Dinámico</i>	<i>Tornillo recto</i>	<i>Scanbody</i>	<i>Réplica</i>	<i>Código biblioteca</i>
SMALL Titanium <i>Titanio</i>	IND3UCS35/TIA	IND3UCH35/TIA	TPDH16L6	TBRA16L70	SBIND3NP/PK	RUC35	DAS_E_0023
RP Titanium <i>Titanio</i>	IND3UCS41/TIA	IND3UCH41/TIA	TPDH2L6	TBRA2L70	SBIND3NP/PK	RUC41	DAS_E_0024



	Hex.	h.
SMALL	2,40	0,70
RP	2,70	0,70

Compatible with - *Compatible con* MICRODENT

Mini - MICRODENT



Platform	Non-Engaging	Engaging	Dynamic screw	Straight screw	Scanbody	Analog	Library code
<i>Plataforma</i>	<i>Rotatorio</i>	<i>No Rotatorio</i>	<i>Tornillo Dinámico</i>	<i>Tornillo recto</i>	<i>Scanbody</i>	<i>Réplica</i>	<i>Código biblioteca</i>
NP Titanium <i>Titanio</i>	IND3UCS33/TIA	IND3UCH33/TIA	TPDH18	---	SBIND3NP/PK	---	DAS_E_0003



	Hex.	h.
NP	2,55	0,70

Universal - MICRODENT



RP Titanium <i>Titanio</i>	IND3UCS41/TIA	IND3UCH41/TIA	TPDH2L6	TBRA2L70	SBIND3RP/PK	RUC41	DAS_E_0024
-------------------------------	---------------	---------------	---------	----------	-------------	-------	------------



	Hex.	h.
RP	2,70	0,70

Ektos - MICRODENT



Ø3,5 Titanium <i>Titanio</i>	IND3ZIMR35/TIA	IND3ZIMH35/TIA	TPDH18L75	TBT118L68	SBIND3NP/PK	---	DAS_E_0040
---------------------------------	----------------	----------------	-----------	-----------	-------------	-----	------------



Compatible with - *Compatible con* MIS

Lance - MIS



Platform	Non-Engaging	Engaging	Dynamic screw	Straight screw	Scanbody	Analog	Library code
<i>Plataforma</i>	<i>Rotatorio</i>	<i>No Rotatorio</i>	<i>Tornillo Dinámico</i>	<i>Tornillo recto</i>	<i>Scanbody</i>	<i>Réplica</i>	<i>Código biblioteca</i>
RP Titanium <i>Titanio</i>	IND3UCS41/TIA	IND3UCH41/TIA	TPDH2L6	TBRA2L70	SBIND3RP/PK	RUC41	DAS_E_0024

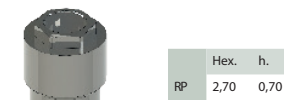

Seven - MIS



NP Titanium <i>Titanio</i>	IND3MM4RNP/TIA	IND3MM4HNP/TIA	TPDH16L71	---	SBIND3NP/PK	---	DAS_E_0019
ST Titanium <i>Titanio</i>	IND3ZIMR35/TIA	IND3ZIMH35/TIA	TPDH17L71	TZIML76	SBIND3NP/PK	RZIM35	DAS_E_0040
WP Titanium <i>Titanio</i>	IND3ZIMR45/TIA	IND3ZIMH45/TIA	TPDH17L71	TZIML76	SBIND3RP/PK	RZIM45	DAS_E_0041



M4 - MIS



NP Titanium <i>Titanio</i>	IND3MM4RNP/TIA	IND3MM4HNP/TIA	TPDH16L71	---	SBIND3NP/PK	---	DAS_E_0019
ST Titanium <i>Titanio</i>	IND3ZIMR35/TIA	IND3ZIMH35/TIA	TPDH17L71	TZIML76	SBIND3NP/PK	RZIM35	DAS_E_0040
WP Titanium <i>Titanio</i>	IND3ZIMR45/TIA	IND3ZIMH45/TIA	TPDH17L71	TZIML76	SBIND3RP/PK	RZIM45	DAS_E_0041



C1 - MIS



NP Titanium <i>Titanio</i>	IND3MC1RNP/TIA	IND3MC1HNP/TIA	TPDH16L71	---	SBIND3NP/PK	---	DAS_E_0016
RP Titanium <i>Titanio</i>	IND3MC1RRP/TIA	IND3MC1HRP/TIA	TPDH17L73	---	SBIND3RP/PK	---	DAS_E_0017
WP Titanium <i>Titanio</i>	IND3MC1RWP/TIA	IND3MC1HWP/TIA	TPDH17L73	---	SBIND3RP/PK	---	DAS_E_0018



V3 - MIS



RP Titanium <i>Titanio</i>	IND3MC1RRP/TIA	IND3MC1HRP/TIA	TPDH17L73	---	SBIND3RP/PK	---	DAS_E_0017
----------------------------------	----------------	----------------	-----------	-----	-------------	-----	------------



Multi-Unit - MIS



GENERAL Titanium <i>Titanio</i>	IND3MMU/TIA	--	TPDH16	---	SBIND3MURP/PK	---	DAS_E_0020
---------------------------------------	-------------	----	--------	-----	---------------	-----	------------



Compatible with - *Compatible con* MOZO-GRAU

MG Osseous - MOZO-GRAU



Platform	Non-Engaging	Engaging	Dynamic screw	Straight screw	Scanbody	Analog	Library code
Plataforma	Rotatorio	No Rotatorio	Tornillo Dinámico	Tornillo recto	Scanbody	Réplica	Código biblioteca
NP Titanium Titanio	IND3UCS33/TiA	IND3UCH33/TiA	TPDH2L65	T3I2L70	SBIND3NP/PK	RUC33	DAS_E_0003
RP Titanium Titanio	IND3UCS41/TiA	IND3UCH41/TiA	TPDH2L6	TBRA2L70	SBIND3RP/PK	RUC41	DAS_E_0024



	Hex.	h.
NP	2,55	0,70
RP	2,70	0,70

MG Inhex - MOZO-GRAU



Platform	Non-Engaging	Engaging	Dynamic screw	Straight screw	Scanbody	Analog	Library code
Plataforma	Rotatorio	No Rotatorio	Tornillo Dinámico	Tornillo recto	Scanbody	Réplica	Código biblioteca
RP Titanium Titanio	IND3ASTRRP/TiA	IND3ASTHRP/TiA	TPDH16L76	TAST16L82	SBIND3RP/PK	RASTRP	DAS_E_0004
WP Titanium Titanio	IND3ASTRWP/TiA	IND3ASTHWP/TiA	TPDH2L90	TAST2L103	SBIND3RP/PK	RASTWP	DAS_E_0005



Compatible with - *Compatible con* MPI

External Connection EH *Conexión Externa HE* - MPI



Platform	Non-Engaging	Engaging	Dynamic screw	Straight screw	Scanbody	Analog	Library code
Plataforma	Rotatorio	No Rotatorio	Tornillo Dinámico	Tornillo recto	Scanbody	Réplica	Código biblioteca
RP Titanium Titanio	IND3UCS41/TiA	IND3UCH41/TiA	TPDH2L6	TBRA2L70	SBIND3RP/PK	RUC41	DAS_E_0024



	Hex.	h.
RP	2,70	0,70

Internal Connection CM *Conexión Interna CM* - MPI



RP Titanium Titanio	IND3ASTRRP/TiA	IND3ASTHRP/TiA	TPDH16L76	TAST16L82	SBIND3RP/PK	RASTRP	DAS_E_0004
WP Titanium Titanio	IND3ASTRWP/TiA	IND3ASTHWP/TiA	TPDH2L90	TAST2L103	SBIND3RP/PK	RASTWP	DAS_E_0005



Compatible with - *Compatible con* NEOBIOTECH

EB External System *Sistema Externo EB* - NEOBIOTECH



Platform	Non-Engaging	Engaging	Dynamic screw	Straight screw	Scanbody	Analog	Library code
<i>Plataforma</i>	<i>Rotatorio</i>	<i>No Rotatorio</i>	<i>Tornillo Dinámico</i>	<i>Tornillo recto</i>	<i>Scanbody</i>	<i>Réplica</i>	<i>Código biblioteca</i>
NP Titanium <i>Titanio</i>	IND3UCS35/TIA	IND3UCH35/TIA	TPDH16L6	TBRA16L70	SBIND3NP/PK	RUC35	DAS_E_0023



	Hex.	h.
RP	2,40	0,70

Compatible with - *Compatible con* NEODENT

Cono Morse Mini Pilar - NEODENT



Platform	Non-Engaging	Engaging	Dynamic screw	Straight screw	Scanbody	Analog	Library code
<i>Plataforma</i>	<i>Rotatorio</i>	<i>No Rotatorio</i>	<i>Tornillo Dinámico</i>	<i>Tornillo recto</i>	<i>Scanbody</i>	<i>Réplica</i>	<i>Código biblioteca</i>
RP Titanium <i>Titanio</i>	IND3CO41/TIA	---	TPDH14L39	TMU14L35	SBIND3MURP/PK	RMU48	DAS_E_0025



Smart HE - NEODENT



RP Ø4,1	Titanium <i>Titanio</i>	IND3UCS41/TIA	IND3UCH41/TIA	TPDH2L70	TBRA2L70	SBIND3RP/PK	---*	DAS_E_0024
------------	----------------------------	---------------	---------------	----------	----------	-------------	------	------------

*Use TPDH2L6 screw for original analog
*Usar tornillo TPDH2L6 para réplica original



	Hex.	h.
RP	2,70	0,70

Compatible with - *Compatible con* NOBEL BIOCARE

Branemark - NOBEL BIOCARE



Platform	Non-Engaging	Engaging	Dynamic screw	Straight screw	Scanbody	Analog	Library code
<i>Plataforma</i>	<i>Rotatorio</i>	<i>No Rotatorio</i>	<i>Tornillo Dinámico</i>	<i>Tornillo recto</i>	<i>Scanbody</i>	<i>Réplica</i>	<i>Código biblioteca</i>
NP Titanium <i>Titanio</i>	IND3UCS35/TIA	IND3UCH35/TIA	TPDH16L6	TBRA16L70	SBIND3NP/PK	RUC35	DAS_E_0023
RP Titanium <i>Titanio</i>	IND3UCS41/TIA	IND3UCH41/TIA	TPDH2L6	TBRA2L70	SBIND3RP/PK	RUC41	DAS_E_0024



	Hex.	h.
NP	2,40	0,70
RP	2,70	0,70

Compatible with - *Compatible con* NOBEL BIOCARE

Multi-Unit - NOBEL BIOCARE



Platform	Non-Engaging	Engaging	Dynamic screw	Straight screw	Scanbody	Analog	Library code
<i>Plataforma</i>	<i>Rotatorio</i>	<i>No Rotatorio</i>	<i>Tornillo Dinámico</i>	<i>Tornillo recto</i>	<i>Scanbody</i>	<i>Réplica</i>	<i>Código biblioteca</i>
RP Titanium <i>Titanio</i>	IND3CO41/TIA	---	TPDH14L39	TMU14L35	SBIND3MURP/PK	RMU48	DAS_E_0025



Replace - NOBEL BIOCARE



NP Titanium <i>Titanio</i>	IND3RPLR35/TIA	IND3RPLT35/TIA	TPDH18L75	TRPL18L83	SBIND3NP/PK	RRPL35	DAS_E_0026
RP Titanium <i>Titanio</i>	IND3RPLR43/TIA	IND3RPLT43/TIA	TPDH2L90	TRPL2L100	SBIND3RP/PK	RRPL43	DAS_E_0027
WP Titanium <i>Titanio</i>	IND3RPLR50/TIA	IND3RPLT50/TIA	TPDH2L90	TRPL2L100	SBIND3RP/PK	RRPL50	DAS_E_0028



Active - NOBEL BIOCARE



NP Titanium <i>Titanio</i>	IND3ACTRNP/TIA	IND3ACTHNP/TIA	TPDH16L73	TACT16L73	SBIND3NP/PK	RACTNP	DAS_E_0021
RP Titanium <i>Titanio</i>	IND3ACTRRP/TIA	IND3ACTHRP/TIA	TPDH2L75	TACT2L73	SBIND3RP/PK	RACTRP	DAS_E_0022



Compatible with - *Compatible con* OSSEOLIFE

OEX - OSSEOLIFE



Platform	Non-Engaging	Engaging	Dynamic screw	Straight screw	Scanbody	Analog	Library code
<i>Plataforma</i>	<i>Rotatorio</i>	<i>No Rotatorio</i>	<i>Tornillo Dinámico</i>	<i>Tornillo recto</i>	<i>Scanbody</i>	<i>Réplica</i>	<i>Código biblioteca</i>
RP Titanium <i>Titanio</i>	IND3UCS41/TIA	IND3UCH41/TIA	TPDH2L6	TBRA2L70	SBIND3RP/PK	RUC41	DAS_E_0024



	Hex.	h.
RP	2,70	0,70

Compatible with - *Compatible con* OSSTEM IMPLANT

TS - OSSTEM IMPLANT

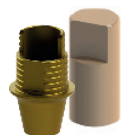

Platform		Non-Engaging	Engaging	Dynamic screw	Straight screw	Scanbody	Analog	Library code
<i>Plataforma</i>		<i>Rotatorio</i>	<i>No Rotatorio</i>	<i>Tornillo Dinámico</i>	<i>Tornillo recto</i>	<i>Scanbody</i>	<i>Réplica</i>	<i>Código biblioteca</i>
MINI*	Titanium <i>Titanio</i>	IND30TSRNP/TIA	IND30TSHNP/TIA	TPDH16L94	TCAM16L105	SBIND3NP/PK	---	DAS_E_0029
RP	Titanium <i>Titanio</i>	IND30TSRRP/TIA	IND30TSHRP/TIA	TPDH2L79	---	SBIND3RP/PK	---	DAS_E_0030

*Maxim angulation 20°
*Angulación máxima 20°



US - OSSTEM IMPLANT



MINI Ø3,5	Titanium <i>Titanio</i>	IND3UCS35/TIA	IND3UCH35/TIA	TPDH16L6	TBRA16L70	SBIND3NP/PK	RUC35	DAS_E_0023
RP Ø4,1	Titanium <i>Titanio</i>	IND3UCS41/TIA	IND3UCH41/TIA	TPDH2L6	TBRA2L70	SBIND3RP/PK	RUC41	DAS_E_0024



	Hex.	h.
NP	2,40	0,70
RP	2,70	0,70

Compatible with - *Compatible con* OSTEOPLUS

She - OSTEOPLUS



Platform		Non-Engaging	Engaging	Dynamic screw	Straight screw	Scanbody	Analog	Library code
<i>Plataforma</i>		<i>Rotatorio</i>	<i>No Rotatorio</i>	<i>Tornillo Dinámico</i>	<i>Tornillo recto</i>	<i>Scanbody</i>	<i>Réplica</i>	<i>Código biblioteca</i>
NP	Titanium <i>Titanio</i>	IND3UCS35BT/TIA	IND3UCH35BT/TIA	TPDH2L65	---	SBIND3NP/PK	RUC35BT	DAS_E_0009
RP	Titanium <i>Titanio</i>	IND3UCS41/TIA	IND3UCH41/TIA	TPDH2L65	TBRA2L70	SBIND3RP/PK	RUC41	DAS_E_0024



	Hex.	h.
NP	2,50	1,10
RP	2,70	0,70

Shi - OSTEOPLUS



Ø3,5	Titanium <i>Titanio</i>	IND3ZIMR35/TIA	IND3ZIMH35/TIA	TPDH17L71	TZIML76	SBIND3NP/PK	RZIM35	DAS_E_0040
------	----------------------------	----------------	----------------	-----------	---------	-------------	--------	------------



Compatible with - *Compatible con* PHIBO

TSH/BTN Serie 3 - PHIBO

Platform	Non-Engaging	Engaging	Dynamic screw	Straight screw	Scanbody	Analog	Library code
<i>Plataforma</i>	<i>Rotatorio</i>	<i>No Rotatorio</i>	<i>Tornillo Dinámico</i>	<i>Tornillo recto</i>	<i>Scanbody</i>	<i>Réplica</i>	<i>Código biblioteca</i>
RP Titanium <i>Titano</i>	IND3UCS41/TiA	IND3UCH41/TiA	TPDH2L6	T3I2L70	SBIND3RP/PK	RUC41	DAS_E_0024



TSH/BTN Serie 4 - PHIBO

RP Titanium <i>Titano</i>	IND3UCS41/TiA	IND3UCH41/TiA	TPDH2L6	T3I2L70	SBIND3RP/PK	RUC41	DAS_E_0024
---------------------------------	---------------	---------------	---------	---------	-------------	-------	------------

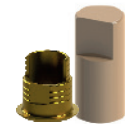

Compatible with - *Compatible con* PROCLINIC

External Connection *Conexión Externa* - PROCLINIC

Platform	Non-Engaging	Engaging	Dynamic screw	Straight screw	Scanbody	Analog	Library code
<i>Plataforma</i>	<i>Rotatorio</i>	<i>No Rotatorio</i>	<i>Tornillo Dinámico</i>	<i>Tornillo recto</i>	<i>Scanbody</i>	<i>Réplica</i>	<i>Código biblioteca</i>
RP Titanium <i>Titano</i>	IND3UCS41/TiA	IND3UCH41/TiA	TPDH2L6	TBRA2L70	SBIND3RP/PK	RUC41	DAS_E_0024

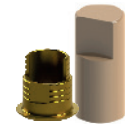

Internal Hexagon *Hexágono Interno* - PROCLINIC

NP Titanium <i>Titano</i>	IND3ZIMR35/TiA	IND3ZIMH35/TiA	TPDH17L71	TZIML76	SBIND3NP/PK	RZIM35	DAS_E_0040
RP Titanium <i>Titano</i>	IND3ZIMR45/TiA	IND3ZIMH45/TiA	TPDH17L71	TZIML76	SBIND3RP/PK	RZIM45	DAS_E_0041

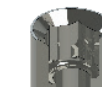

Compatible with - *Compatible con* PROCLINIC

Internal Octagon *Octogono Interno* - PROCLINIC



Platform	Non-Engaging	Engaging	Dynamic screw	Straight screw	Scanbody	Analog	Library code
<i>Plataforma</i>	<i>Rotatorio</i>	<i>No Rotatorio</i>	<i>Tornillo Dinámico</i>	<i>Tornillo recto</i>	<i>Scanbody</i>	<i>Réplica</i>	<i>Código biblioteca</i>
RP Titanium <i>Titanio</i>	IND3OCR48/TIA	IND3OCO48/TIA	TPDH2L67	TSTR2L67	SBIND3OCR/PK	ROC48	DAS_E_0037



Compatible with - *Compatible con* RADHEX

PHE - RADHEX



Platform	Non-Engaging	Engaging	Dynamic screw	Straight screw	Scanbody	Analog	Library code
<i>Plataforma</i>	<i>Rotatorio</i>	<i>No Rotatorio</i>	<i>Tornillo Dinámico</i>	<i>Tornillo recto</i>	<i>Scanbody</i>	<i>Réplica</i>	<i>Código biblioteca</i>
NP Titanium <i>Titanio</i>	IND3UCS35/TIA	IND3UCH35/TIA	TPDH16L76	TBRA16L70	SBIND3NP/PK	---	DAS_E_0023
RP Titanium <i>Titanio</i>	IND3UCS41/TIA	IND3UCH41/TIA	TPDH2L65	TBRA2L70	SBIND3RP/PK	RUC41	DAS_E_0024



	Hex.	h.
RP	2,70	0,70

PHI - RADHEX



NP Titanium <i>Titanio</i>	IND3ZIMR35/TIA	IND3ZIMH35/TIA	TPDH18L75	---	SBIND3NP/PK	--	DAS_E_0040
RP Titanium <i>Titanio</i>	IND3ZIMR45/TIA	IND3ZIMH45/TIA	TPDH17L71	TZIML76	SBIND3RP/PK	RZIM45	DAS_E_0041



Compatible with - *Compatible con* SGS

P1 - SGS



Platform	Non-Engaging	Engaging	Dynamic screw	Straight screw	Scanbody	Analog	Library code
<i>Plataforma</i>	<i>Rotatorio</i>	<i>No Rotatorio</i>	<i>Tornillo Dinámico</i>	<i>Tornillo recto</i>	<i>Scanbody</i>	<i>Réplica</i>	<i>Código biblioteca</i>
Ø 3,2 Titanium <i>Titanio</i>	IND3ZIMR35/TIA	IND3ZIMH35/TIA	TPDH17L71	TZIML76	SBIND3NP/PK	RZIM35	DAS_E_0040
Ø 3,75 Titanium <i>Titanio</i>	IND3ZIMR35/TIA	IND3ZIMH35/TIA	TPDH17L71	TZIML76	SBIND3NP/PK	RZIM35	DAS_E_0040
Ø 4,2 Titanium <i>Titanio</i>	IND3ZIMR35/TIA	IND3ZIMH35/TIA	TPDH17L71	TZIML76	SBIND3NP/PK	RZIM35	DAS_E_0040
Ø 5 Titanium <i>Titanio</i>	IND3ZIMR35/TIA	IND3ZIMH35/TIA	TPDH17L71	TZIML76	SBIND3NP/PK	RZIM35	DAS_E_0040
Ø 6 Titanium <i>Titanio</i>	IND3ZIMR35/TIA	IND3ZIMH35/TIA	TPDH17L71	TZIML76	SBIND3NP/PK	RZIM35	DAS_E_0040



Compatible with - *Compatible con* SGS

P7 - SGS



Platform	Non-Engaging	Engaging	Dynamic screw	Straight screw	Scanbody	Analog	Library code
Plataforma	Rotatorio	No Rotatorio	Tornillo Dinámico	Tornillo recto	Scanbody	Réplica	Código biblioteca
Ø 3,2 Titanium Titanio	IND3ZIMR35/TIA	IND3ZIMH35/TIA	TPDH17L71	TZIML76	SBIND3NP/PK	RZIM35	DAS_E_0040
Ø 3,75 Titanium Titanio	IND3ZIMR35/TIA	IND3ZIMH35/TIA	TPDH17L71	TZIML76	SBIND3NP/PK	RZIM35	DAS_E_0040
Ø 4,2 Titanium Titanio	IND3ZIMR35/TIA	IND3ZIMH35/TIA	TPDH17L71	TZIML76	SBIND3NP/PK	RZIM35	DAS_E_0040
Ø 5 Titanium Titanio	IND3ZIMR35/TIA	IND3ZIMH35/TIA	TPDH17L71	TZIML76	SBIND3NP/PK	RZIM35	DAS_E_0040
Ø 6 Titanium Titanio	IND3ZIMR35/TIA	IND3ZIMH35/TIA	TPDH17L71	TZIML76	SBIND3NP/PK	RZIM35	DAS_E_0040



Compatible with - *Compatible con* SIGNO VINCES

Compact 4,5 - SIGNO VINCES



Platform	Non-Engaging	Engaging	Dynamic screw	Straight screw	Scanbody	Analog	Library code
Plataforma	Rotatorio	No Rotatorio	Tornillo Dinámico	Tornillo recto	Scanbody	Réplica	Código biblioteca
CM Ø 3,8 Titanium Titanio	IND3ASTRWP/TIA	IND3ASTHWP/TIA	TPDH2L90	TAST2L103	SBIND3RP/PK	RASTWP	DAS_E_0005



Duo - SIGNO VINCES



RP Titanium Titanio	IND3UCS41/TIA	IND3UCH41/TIA	TPDH2L74	TBRA2L70	SBIND3RP/PK	---	DAS_E_0024
---------------------------	---------------	---------------	----------	----------	-------------	-----	------------

*Use TPDH2L6 screw for original analog
*Usar tornillo TPDH2L6 para réplica original



	Hex.	h.
RP	2,70	0,70

Duocon 3,8 - SIGNO VINCES



CM Ø 3,8 Titanium Titanio	IND3ASTRRP/TIA	IND3ASTHRP/TIA	TPDH16L76	TAST16L82	SBIND3RP/PK	RASTRP	DAS_E_0040
---------------------------------	----------------	----------------	-----------	-----------	-------------	--------	------------



Compatible with - *Compatible con* SIGNO VINCES

Integra - SIGNO VINCES



Platform	Non-Engaging	Engaging	Dynamic screw	Straight screw	Scanbody	Analog	Library code
Plataforma	Rotatorio	No Rotatorio	Tornillo Dinámico	Tornillo recto	Scanbody	Réplica	Código biblioteca
RP Titanium Titanio	IND3UCS41/TIA	IND3UCH41/TIA	TPDH2L70	TBRA2L70	SBIND3RP/PK	---*	DAS_E_0024

*Use TPDH2L6 screw for original analog
*Usar tornillo TPDH2L6 para réplica original



Compatible with - *Compatible con* STRAUMANN

Internal Octagon *Octógono Interno* - STRAUMANN



Platform	Non-Engaging	Engaging	Dynamic screw	Straight screw	Scanbody	Analog	Library code
Plataforma	Rotatorio	No Rotatorio	Tornillo Dinámico	Tornillo recto	Scanbody	Réplica	Código biblioteca
RP Titanium Titanio	IND3OCR48/TIA	IND3OCO48/TIA	TPDH2L67	TSTR2L67	SBIND3OCR/PK	ROC48	DAS_E_0037



Bone Level - STRAUMANN



NP(1) Titanium Titanio	IND3BONRNP/TIA	IND3BONHNP/TIA	TPDH16L78	TBON16L79	SBIND3NP/PK	RBONNP	DAS_E_0033	(1)Gingival height 1mm (1)Altura gingival 1mm
RP(1) Titanium Titanio	IND3BONRRP/TIA	IND3BONHRP/TIA	TPDH16L78	TBON16L79	SBIND3RP/PK	RBONRP	DAS_E_0035	
NP(2) Titanium Titanio	IND3BONRNP2/TIA	IND3BONHNP2/TIA	TPDH16L78	TBON16L79	SBIND3NP/PK	RBONNP	DAS_E_0034	(2)Gingival height 2mm (2)Altura gingival 2mm
RP(2) Titanium Titanio	IND3BONRRP2/TIA	IND3BONHRP2/TIA	TPDH16L78	TBON16L79	SBIND3RP/PK	RBONRP	DAS_E_0036	



Compatible with - *Compatible con* SYBRON IMPLANTS SOLUTIONS

Endopore (Innova) - SYBRON IMPLANTS SOLUTIONS



Platform	Non-Engaging	Engaging	Dynamic screw	Straight screw	Scanbody	Analog	Library code
Plataforma	Rotatorio	No Rotatorio	Tornillo Dinámico	Tornillo recto	Scanbody	Réplica	Código biblioteca
RP Titanium Titanio	IND3UCS41/TIA	IND3UCH41/TIA	TPDH2L6	TBRA2L70	SBIND3RP/PK	RUC41	DAS_E_0024



Compatible with - *Compatible con* TITANIUM-FIX

b-fix - TITANIUM-FIX



Platform	Non-Engaging	Engaging	Dynamic screw	Straight screw	Scanbody	Analog	Library code
Plataforma	Rotatorio	No Rotatorio	Tornillo Dinámico	Tornillo recto	Scanbody	Réplica	Código biblioteca
NP Titanium Titanio	IND3ASTRRP/TIA	IND3ASTHRP/TIA	TPDH16L76	TAST16L82	SBIND3RP/PK	RASTRP	DAS_E_0004
WP Titanium Titanio	IND3ASTRWP/TIA	IND3ASTHWP/TIA	TPDH2L90	TAST2L103	SBIND3RP/PK	RASTWP	DAS_E_0005



Compatible with - *Compatible con* TRI DENTAL IMPLANTS

Tri-Vent - TRI DENTAL IMPLANTS



Platform	Non-Engaging	Engaging	Dynamic screw	Straight screw	Scanbody	Analog	Library code
Plataforma	Rotatorio	No Rotatorio	Tornillo Dinámico	Tornillo recto	Scanbody	Réplica	Código biblioteca
Ø 3,75 Titanium Titanio	IND3ZIMR35/TIA	IND3ZIOHNP/TIA	TPDH17L71	TZIML76	SBIND3NP/PK	RZIM35	DAS_E_0042
Ø 4,1 Titanium Titanio	IND3ZIMR35/TIA	IND3ZIOHNP/TIA	TPDH17L71	TZIML76	SBIND3NP/PK	RZIM35	DAS_E_0042
Ø 4,7 Titanium Titanio	IND3ZIMR35/TIA	IND3ZIOHNP/TIA	TPDH17L71	TZIML76	SBIND3NP/PK	RZIM35	DAS_E_0042



Compatible with - *Compatible con* TRINON

Q2 - TRINON



Platform	Non-Engaging	Engaging	Dynamic screw	Straight screw	Scanbody	Analog	Library code
Plataforma	Rotatorio	No Rotatorio	Tornillo Dinámico	Tornillo recto	Scanbody	Réplica	Código biblioteca
RP Titanium Titanio	IND3UCS41/TIA	IND3UCH41/TIA	TPDH2L6	TBRA2L70	SBIND3RP/PK	RUC41	DAS_E_0024



	Hex.	h.
RP	2,70	0,70

QK - TRINON



RP Titanium Titanio	IND3OCR48/TIA	IND3OC048/TIA	TPDH2L67	TSTR2L67	SBIND3OCR/PK	ROC48	DAS_E_0037
------------------------	---------------	---------------	----------	----------	--------------	-------	------------



Compatible with - *Compatible con* XIVE

Internal *Interno* - XIVE



Platform	Non-Engaging	Engaging	Dynamic screw	Straight screw	Scanbody	Analog	Library code
<i>Plataforma</i>	<i>Rotatorio</i>	<i>No Rotatorio</i>	<i>Tornillo Dinámico</i>	<i>Tomillo recto</i>	<i>Scanbody</i>	<i>Réplica</i>	<i>Código biblioteca</i>
Ø 3,4 Titanium <i>Titanio</i>	IND3XIVR34/TIA	IND3XIVH34/TIA	TPDH16L81	---	SBIND3NP/PK	---	DAS_E_0038
Ø 3,8 Titanium <i>Titanio</i>	IND3XIVR38/TIA	IND3XIVH38/TIA	TPDH16L81	---	SBIND3RP/PK	---	DAS_E_0039



Compatible with - *Compatible con* ZIMMER

Screw-Vent - ZIMMER



Platform	Non-Engaging	Engaging	Dynamic screw	Straight screw	Scanbody	Analog	Library code
<i>Plataforma</i>	<i>Rotatorio</i>	<i>No Rotatorio</i>	<i>Tornillo Dinámico</i>	<i>Tomillo recto</i>	<i>Scanbody</i>	<i>Réplica</i>	<i>Código biblioteca</i>
NP Titanium <i>Titanio Friction-Fit</i>	IND3ZIMR35/TIA	IND3ZIMH35/TIA	TPDH17L71	TZIML76	SBIND3NP/PK	RZIM35	DAS_E_0040
	IND3ZIMR35/TIA	IND3ZIOHNP/TIA	TPDH17L71	TZIML76	SBIND3NP/PK	RZIM35	DAS_E_0042
RP Titanium <i>Titanio Friction-Fit</i>	IND3ZIMR45/TIA	IND3ZIMH45/TIA	TPDH17L71	TZIML76	SBIND3RP/PK	RZIM45	DAS_E_0041
	IND3ZIMR45/TIA	IND3ZIOHRP/TIA	TPDH17L71	TZIML76	SBIND3RP/PK	RZIM45	DAS_E_0043



Swiss-Plus - ZIMMER



Ø 4,8 Titanium <i>Titanio</i>	IND3OCR48/TIA	IND3OCO48/TIA	TPDH2L67	TSTR2L67	SBIND3OCR/PK	ROC48	DAS_E_0037
----------------------------------	---------------	---------------	----------	----------	--------------	-------	------------



PRE-MILLED ABUTMENT BLANK COMPATIBILITIES

COMPATIBILIDADES CILINDRO PRE-FRESADO

ACE, 52

External Hex.
Infinity TRI-CAM
Infinity Internal Hex.

ADIN, 52

Swell
Touareg-S/Touareg-OS
Touareg CloseFit

ALPHABIO, 53

External Alphabio
Alphabio Externo
Internal Alphabio
Alphabio Interno

ANCLADEN, 54

Anclalock

ANTHOGRYR, 54

Anthofit HE
Ossfit

ARDS, 55

Smart
Classic
Premium

ASTRA, 55

Aqua
Lilac

AVINENT, 56

HE
HI

BIOGENESIS, 57

3Icon
Aticon
Iticon

BIOHORIZON, 58

Internal *Interno*

BIOMET 3I, 58

Osseofite
Certain

BIONER, 59

Ikelt/Bikelt
Hikelt

BTI, 59

External Connection Tiny
Conexión Externa Tiny
External Connection
Conexión Externa
Internal Connection
Conexión Interna

BTK, 60

Klassic/Konic

B&W, 60

External Connection
Conexión Externa

CORTEX, 61

Dynamix
Classix
Saturn

DENTALTECH, 61

Implogic

DENTIUM, 62

SimpleLine II

DIO IMPLANTS, 62

External *Externo*

DSP BIOMEDICAL, 62

External Hexagon
Hexágono Externo

ELITE MEDICAL, 63

External Connection
Conexión Externa

EUROTEKNIKA, 63

Naturactis
Uneva
Uneva (Platform Switching)
Natea
Aesthetica
Naturall

GALIMPLANT, 65

External Connection
Conexión Externa
Internal Connection
Conexión Interna

GMI, 65

Phoenix
Frontier

GT MEDICAL, 66

Best Fit Internal Octagon
Best Fit Octógono Interno
Best Fit Internal Hexagon
Best Fit Hexágono Interno
Best Fit External Hexagon
Best Fit Hexágono Externo

HI-TECH, 66

Self Thread SLT
Self Thread GTI
LGI Plus

IMBIODENT, 67

Imbiodent

IMPLANT DIRECT, 68

Replus/Replant/Reactive
Legacy
Swishplant/Swishplus
Interactive

JDENTALCARE, 69

JDEvolution

KEYSTONE, 69

Restore

KLOCKNER, 69

KL

LEADER, 70

Tixos Internal Hexagon
Tixos Hexágono Interno
Tixos External Hexagon
Tixos Hexágono Externo

MEGAGEN, 70

AnyOne External
AnyOne Externo

MICRODENT, 71

Universal
Ektos

MIS, 71

Lance
Seven
M4

MOZO GRAU, 72

MG Osseous
MG Inhex

MPI, 73

External Connection HE
Conexión Externa HE
Internal Connection CM
Conexión Interna CM

NEODENT, 73

Smart HE

NOBEL BIOCARE, 74

Branemark
Replace
Active

OSSEOLIFE, 74

OEX

OSSTEM IMPLANT, 75

US

OSTEOPLUS, 75

She
Shi

PHIBO, 76

TSH/BTN Serie 3
TSH/BTN Serie 4

PROCLINIC, 76

External Connection
Conexión Externa
Internal Hexagon
Hexágono Interno
Internal Octagon
Octógono Interno

RADHEX, 77

PHE
PHI

SGS, 78

P1
P7

SIGNO VINCES, 79

Duo
Inttegra
Compact 4,5
Duocon 3,8

STRAUMANN, 80

Internal Octagon
Octógono Interno
Bone Level

SYBRON IMPLANTS SOLUTIONS, 80

Endopore (Innova)

TITANIUM-FIX, 81

b-fix

TRI DENTAL IMPLANTS, 81

Tri-Vent

TRINON, 81

Q2
QK

ZIMMER, 82

Screw-Vent
Swiss-Plus

Compatible with - *Compatible con* ACE

External Hex. - ACE



Platform <i>Plataforma</i>		Pre-milled abutment blank <i>Cilindro pre-fresado</i>	Straight screw <i>Tornillo recto</i>	Analog <i>Réplica</i>
RP	Titanium <i>Titanio</i>	PMUCH41/Ti	TBRA2L70	RUC41
	Cobalt-Chrome <i>Cromo Cobalto</i>	PMUCH41/CC	TBRA2L70	RUC41



Infinity TRI-CAM - ACE



RP	Titanium <i>Titanio</i>	PMRPLT43/Ti	TRPL2L100	RRPL43
	Cobalt-Chrome <i>Cromo Cobalto</i>	PMRPLT43/CC	TRPL2L100	RRPL43



Infinity Internal Hex. - ACE



NP	Titanium <i>Titanio</i>	PMZIMH35/Ti	TZIML76	RZIM35
	Cobalt-Chrome <i>Cromo Cobalto</i>	PMZIMH35/CC	TZIML76	RZIM35
RP	Titanium <i>Titanio</i>	PMZIMH45/Ti	TZIML76	RZIM45
	Cobalt-Chrome <i>Cromo Cobalto</i>	PMZIMH45/CC	TZIML76	RZIM45



Compatible with - *Compatible con* ADIN

Swell - ADIN



Platform <i>Plataforma</i>		Pre-milled abutment blank <i>Cilindro pre-fresado</i>	Straight screw <i>Tornillo recto</i>	Analog <i>Réplica</i>
Ø 3,3	Titanium <i>Titanio</i>	PMZIMH35/Ti	TZIML76	RZIM35
Ø 3,75				
Ø 4,2	Cobalt-Chrome <i>Cromo Cobalto</i>	PMZIMH35/CC	TZIML76	RZIM35
Ø 5				
Ø 6				



Compatible with - *Compatible con* ADIN

Touareg-S / Touareg-OS - ADIN



Platform <i>Plataforma</i>	Pre-milled abutment blank <i>Cilindro pre-fresado</i>	Straight screw <i>Tornillo recto</i>	Analog <i>Réplica</i>
Ø 3,5 Ø 3,75 Ø 4,2 Ø 5 Ø 6 Titanium <i>Titanio</i> Cobalt-Chrome <i>Cromo Cobalto</i>	PMZIMH35/Ti PMZIMH35/CC	TZIML76 TZIML76	RZIM35 RZIM35



Touareg Closefit - ADIN



WP Ø 4,3 Ø 5 Titanium <i>Titanio</i> Cobalt-Chrome <i>Cromo Cobalto</i>	PMACTHRP/Ti PMACTHRP/CC	TACT2L73 TACT2L73	RACTRP RACTRP
---	----------------------------	----------------------	------------------



Compatible with - *Compatible con* ALPHABIO

External Alphabio *Alphabio Externo* - ALPHABIO



Platform <i>Plataforma</i>	Pre-milled abutment blank <i>Cilindro pre-fresado</i>	Straight screw <i>Tornillo recto</i>	Analog <i>Réplica</i>
RP Titanium <i>Titanio</i> Cobalt-Chrome <i>Cromo Cobalto</i>	PMUCH41/Ti PMUCH41/CC	TBRA2L70 TBRA2L70	RUC41 RUC41

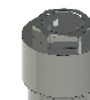

	Hex.	h.
NP	2,40	0,70
RP	2,70	0,70
WP	3,40	0,70

Internal Alphabio *Alphabio Interno* - ALPHABIO



NP RP WP Titanium <i>Titanio</i> Cobalt-Chrome <i>Cromo Cobalto</i>	PMZIMH35/Ti PMZIMH35/CC	TZIML76 TZIML76	RZIM35 RZIM35
---	----------------------------	--------------------	------------------



Compatible with - *Compatible con* ANCLADEN

Anclalock - ANCLADEN



Platform <i>Plataforma</i>	Pre-milled abutment blank <i>Cilindro pre-fresado</i>	Straight screw <i>Tornillo recto</i>	Analog <i>Réplica</i>
Ø 3,75 Ø 4,25 Ø 5 Titanium <i>Titanio</i> Cobalt-Chrome <i>Cromo Cobalto</i>	PMZIMH35/Ti PMZIMH35/CC	TZIML76 TZIML76	RZIM35 RZIM35



Compatible with - *Compatible con* ANTHOGRYR

Anthofit HE - ANTHOGRYR



Platform <i>Plataforma</i>	Pre-milled abutment blank <i>Cilindro pre-fresado</i>	Straight screw <i>Tornillo recto</i>	Analog <i>Réplica</i>
RP Titanium <i>Titanio</i> Cobalt-Chrome <i>Cromo Cobalto</i>	PMUCH41/Ti PMUCH41/CC	TBRA2L70 TBRA2L70	RUC41 RUC41



	Hex.	h.
RP	2,70	0,70
WP	2,70	0,70

Ossfit - ANTHOGRYR



Ø 4,8 Titanium <i>Titanio</i> Cobalt-Chrome <i>Cromo Cobalto</i>	PMSTO48/Ti PMSTO48/CC	TSTR2L67 TSTR2L67	ROC48 ROC48
--	--------------------------	----------------------	----------------



Compatible with - *Compatible con* ARDS

Smart - ARDS



Platform <i>Plataforma</i>	Pre-milled abutment blank <i>Cilindro pre-fresado</i>	Straight screw <i>Tornillo recto</i>	Analog <i>Réplica</i>
Ø 3,75 Ø 4,2 Ø 4,5 Titanium <i>Titanio</i> Cobalt-Chrome <i>Cromo Cobalto</i>	PMZIMH35/TI PMZIMH35/CC	TZIML76 TZIML76	RZIM35 RZIM35



Classic - ARDS



Ø 3,3 Ø 3,75 Ø 4,2 Ø 5 Ø 6 Titanium <i>Titanio</i> Cobalt-Chrome <i>Cromo Cobalto</i>	PMZIMH35/TI PMZIMH35/CC	TZIML76 TZIML76	RZIM35 RZIM35
---	----------------------------	--------------------	------------------



Premium - ARDS



Ø 3,3 Ø 3,75 Ø 4,2 Ø 5 Ø 6 Titanium <i>Titanio</i> Cobalt-Chrome <i>Cromo Cobalto</i>	PMZIMH35/TI PMZIMH35/CC	TZIML76 TZIML76	RZIM35 RZIM35
---	----------------------------	--------------------	------------------



Compatible with - *Compatible con* ASTRA

Aqua - ASTRA



Platform <i>Plataforma</i>	Pre-milled abutment blank <i>Cilindro pre-fresado</i>	Straight screw <i>Tornillo recto</i>	Analog <i>Réplica</i>
RP Titanium <i>Titanio</i> Cobalt-Chrome <i>Cromo Cobalto</i>	PMASTRHP/TI PMASTRHP/CC	TAST16L82 TAST16L82	RASTRP RASTRP



Compatible with - *Compatible con* ASTRA

Lilac - ASTRA



Platform	Pre-milled abutment blank	Straight screw	Analog
<i>Plataforma</i>	<i>Cilindro pre-fresado</i>	<i>Tornillo recto</i>	<i>Réplica</i>
RP Titanium <i>Titanio</i>	PMASTHWP/TI	TAST2L103	RASTWP
Cobalt-Chrome <i>Cromo Cobalto</i>	PMASTHWP/CC	TAST2L103	RASTWP



Compatible with - *Compatible con* AVINENT

HE - AVINENT



Platform	Pre-milled abutment blank	Straight screw	Analog
<i>Plataforma</i>	<i>Cilindro pre-fresado</i>	<i>Tornillo recto</i>	<i>Réplica</i>
RP Titanium <i>Titanio</i>	PMUCH41/TI	TBRA2L70	RUC41
Cobalt-Chrome <i>Cromo Cobalto</i>	PMUCH41/CC	TBRA2L70	RUC41



RP	Hex.	h.
	2,70	0,70

HI - AVINENT



Platform	Pre-milled abutment blank	Straight screw	Analog
<i>Plataforma</i>	<i>Cilindro pre-fresado</i>	<i>Tornillo recto</i>	<i>Réplica</i>
Ø 3,5 Titanium <i>Titanio</i>	PMZIMH35/TI	TZIML76	RZIM35
Ø 4,1 Cobalt-Chrome <i>Cromo Cobalto</i>	PMZIMH35/CC	TZIML76	RZIM35



3Icon - BIOGENESIS



Platform	Pre-milled abutment blank	Straight screw	Analog
<i>Plataforma</i>	<i>Cilindro pre-fresado</i>	<i>Tornillo recto</i>	<i>Réplica</i>
RP Titanium <i>Titanio</i>	PMUCH41/TI	TBRA2L70	RUC41
Cobalt-Chrome <i>Cromo Cobalto</i>	PMUCH41/CC	TBRA2L70	RUC41



	Hex.	h.
NP	2,40	0,70
RP	2,70	0,70
WP	2,70	0,70

Aticon - BIOGENESIS



Platform	Pre-milled abutment blank	Straight screw	Analog
<i>Plataforma</i>	<i>Cilindro pre-fresado</i>	<i>Tornillo recto</i>	<i>Réplica</i>
WP Titanium <i>Titanio</i>	PMASTHWP/TI	TAST2L103	RASTWP
Cobalt-Chrome <i>Cromo Cobalto</i>	PMASTHWP/CC	TAST2L103	RASTWP



Iticon - BIOGENESIS



Platform	Pre-milled abutment blank	Straight screw	Analog
<i>Plataforma</i>	<i>Cilindro pre-fresado</i>	<i>Tornillo recto</i>	<i>Réplica</i>
RP Titanium <i>Titanio</i>	PMSTO48/TI	TSTR2L67	ROC48
Cobalt-Chrome <i>Cromo Cobalto</i>	PMSTO48/CC	TSTR2L67	ROC48

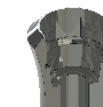

Compatible with - *Compatible con* BIOHORIZON

Internal *Interno* - BIOHORIZON



Platform		Pre-milled abutment blank	Straight screw	Analog
<i>Plataforma</i>		<i>Cilindro pre-fresado</i>	<i>Tornillo recto</i>	<i>Réplica</i>
NP	Titanium <i>Titanio</i>	PMZIMH35/TI	TZIML76	RZIM35
	Cobalt-Chrome <i>Cromo Cobalto</i>	PMZIMH35/CC	TZIML76	RZIM35
RP	Titanium <i>Titanio</i>	PMZIMH45/TI	TZIML76	RZIM45
	Cobalt-Chrome <i>Cromo Cobalto</i>	PMZIMH45/CC	TZIML76	RZIM45



Compatible with - *Compatible con* BIOMET 3I

Osseotite - BIOMET 3I



Platform		Pre-milled abutment blank	Straight screw	Analog
<i>Plataforma</i>		<i>Cilindro pre-fresado</i>	<i>Tornillo recto</i>	<i>Réplica</i>
RP	Titanium <i>Titanio</i>	PMUCH41/TI	T3I2L70	RUC41
	Cobalt-Chrome <i>Cromo Cobalto</i>	PMUCH41/CC	T3I2L70	RUC41

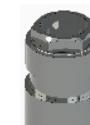

	Hex.	h.
RP	2,70	0,70

Certain - BIOMET 3I



RP	Titanium <i>Titanio</i>	PM3IHRP/TI	T3I16L84	R3IINT40
	Cobalt-Chrome <i>Cromo Cobalto</i>	PM3IHRP/CC	T3I16L84	R3IINT40



Compatible with - *Compatible con* BIONER

Ikelt/Bikelt - BIONER



Platform <i>Plataforma</i>	Pre-milled abutment blank <i>Cilindro pre-fresado</i>	Straight screw <i>Tornillo recto</i>	Analog <i>Réplica</i>
RP Titanium <i>Titanio</i>	PMUCH41/TI	TBRA2L70	RUC41
Cobalt-Chrome <i>Cromo Cobalto</i>	PMUCH41/CC	TBRA2L70	RUC41



Hikelt - BIONER



RP Ø 3,8	Titanium <i>Titanio</i>	PMZIMH35/TI	TZIML76	RZIM35
	Cobalt-Chrome <i>Cromo Cobalto</i>	PMZIMH35/CC	TZIML76	RZIM35
RP Ø 4,7	Titanium <i>Titanio</i>	PMZIMH45/TI	TZIML76	RZIM45
	Cobalt-Chrome <i>Cromo Cobalto</i>	PMZIMH45/CC	TZIML76	RZIM45



Compatible with - *Compatible con* BTI

External Connection Tiny - BTI



Platform <i>Plataforma</i>	Pre-milled abutment blank <i>Cilindro pre-fresado</i>	Straight screw <i>Tornillo recto</i>	Analog <i>Réplica</i>
NP Titanium <i>Titanio</i>	PMUCH35BT/TI	TBTI2L47	RUC35BT
Cobalt-Chrome <i>Cromo Cobalto</i>	PMUCH35BT/CC	TBTI2L47	RUC35BT

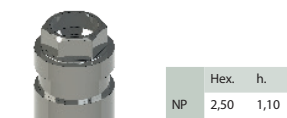

External Connection - BTI



RP Titanium <i>Titanio</i>	PMUCH41/TI	TBRA2L70	RUC41
Cobalt-Chrome <i>Cromo Cobalto</i>	PMUCH41/CC	TBRA2L70	RUC41



Compatible with - *Compatible con* BTI

Internal Connection *Conexión Interna* - BTI



Platform <i>Plataforma</i>	Pre-milled abutment blank <i>Cilindro pre-fresado</i>	Straight screw <i>Tornillo recto</i>	Analog <i>Réplica</i>
RP Titanium <i>Titanio</i>	PMBTIHRP/Ti	TBT118L68	RBT41
Cobalt-Chrome <i>Cromo Cobalto</i>	PMBTIHRP/CC	TBT118L68	RBT41



Compatible with - *Compatible con* BTK

Klassik / Konic - BTK



Platform <i>Plataforma</i>	Pre-milled abutment blank <i>Cilindro pre-fresado</i>	Straight screw <i>Tornillo recto</i>	Analog <i>Réplica</i>
RP Titanium <i>Titanio</i>	PMUCH41/Ti	TBRA2L70	RUC41
Cobalt-Chrome <i>Cromo Cobalto</i>	PMUCH41/CC	TBRA2L70	RUC41



	Hex.	h.
RP	2,70	0,70

Compatible with - *Compatible con* B&W

External Connection *Conexión Externa* - B&W



Platform <i>Plataforma</i>	Pre-milled abutment blank <i>Cilindro pre-fresado</i>	Straight screw <i>Tornillo recto</i>	Analog <i>Réplica</i>
RP Titanium <i>Titanio</i>	PMUCH41/Ti	TBRA2L70	RUC41
Cobalt-Chrome <i>Cromo Cobalto</i>	PMUCH41/CC	TBRA2L70	RUC41



	Hex.	h.
RP	2,70	0,70

Compatible with - *Compatible con* CORTEX

Dynamix - CORTEX



Platform <i>Plataforma</i>	Pre-milled abutment blank <i>Cilindro pre-fresado</i>	Straight screw <i>Tornillo recto</i>	Analog <i>Réplica</i>
Ø 4.2 Titanium <i>Titanio</i> Cobalt-Chrome <i>Cromo Cobalto</i>	PMZIMH35/Ti	TZIML76	RZIM35
	PMZIMH35/CC	TZIML76	RZIM35



Classix- CORTEX



Ø 4.2 Titanium <i>Titanio</i> Cobalt-Chrome <i>Cromo Cobalto</i>	PMZIMH35/Ti	TZIML76	RZIM35
	PMZIMH35/CC	TZIML76	RZIM35



Saturn- CORTEX



Ø 4.2 Titanium <i>Titanio</i> Cobalt-Chrome <i>Cromo Cobalto</i>	PMZIMH35/Ti	TZIML76	RZIM35
	PMZIMH35/CC	TZIML76	RZIM35



Compatible with - *Compatible con* DENTAL TECH

Implagic - DENTAL TECH



Platform <i>Plataforma</i>	Pre-milled abutment blank <i>Cilindro pre-fresado</i>	Straight screw <i>Tornillo recto</i>	Analog <i>Réplica</i>
Ø 4.5 Titanium <i>Titanio</i> Cobalt-Chrome <i>Cromo Cobalto</i>	PMZIMH45/Ti	TZIML76	RZIM45
	PMZIMH45/CC	TZIML76	RZIM45



Compatible with - *Compatible con* DENTIUM

SimpleLine II - DENTIUM



Platform		Pre-milled abutment blank	Straight screw	Analog
Plataforma		Cilindro pre-fresado	Tornillo recto	Réplica
Ø 4,8	Titanium <i>Titanio</i>	PMSTO48/TI	TSTR2L67	ROC48
	Cobalt-Chrome <i>Cromo Cobalto</i>	PMSTO48/CC	TSTR2L67	ROC48



Compatible with - *Compatible con* DIO IMPLANTS

External Externo - DIO IMPLANTS



Platform		Pre-milled abutment blank	Straight screw	Analog
Plataforma		Cilindro pre-fresado	Tornillo recto	Réplica
RP	Titanium <i>Titanio</i>	PMUCH41/TI	TBRA2L70	RUC41
	Cobalt-Chrome <i>Cromo Cobalto</i>	PMUCH41/CC	TBRA2L70	RUC41



RP	Hex.	h.
	2,70	0,70

Compatible with - *Compatible con* DSP BIOMEDICAL

External Hexagon Hexágono Externo - DSP BIOMEDICAL



Platform		Pre-milled abutment blank	Straight screw	Analog
Plataforma		Cilindro pre-fresado	Tornillo recto	Réplica
RP	Titanium <i>Titanio</i>	PMUCH41/TI	TBRA2L70	RUC41
	Cobalt-Chrome <i>Cromo Cobalto</i>	PMUCH41/CC	TBRA2L70	RUC41



RP	Hex.	h.
	2,70	0,70

Compatible with - *Compatible con* ELITE MEDICAL

External Connection *Conexión Externa* - ELITE MEDICAL



Platform <i>Plataforma</i>	Pre-milled abutment blank <i>Cilindro pre-fresado</i>	Straight screw <i>Tornillo recto</i>	Analog <i>Réplica</i>
RP Titanium <i>Titanio</i>	PMUCH41/TI	TBRA2L70	RUC41
Cobalt-Chrome <i>Cromo Cobalto</i>	PMUCH41/CC	TBRA2L70	RUC41



Compatible with - *Compatible con* EUROTEKNIKA

Naturactis - EUROTEKNIKA



Platform <i>Plataforma</i>	Pre-milled abutment blank <i>Cilindro pre-fresado</i>	Straight screw <i>Tornillo recto</i>	Analog <i>Réplica</i>
Ø 3,5 Titanium <i>Titanio</i>	PMASTHRP/TI	TAST16L82	RASTRP
Ø 4			
Ø 4,5 Cobalt-Chrome <i>Cromo Cobalto</i>	PMASTHRP/CC	TAST16L82	RASTRP
Ø 5			



Uneva - EUROTEKNIKA



Ø 3,6 Titanium <i>Titanio</i>	PMUCH41/TI	TBRA2L70	RUC41
Ø 4,1 Cobalt-Chrome <i>Cromo Cobalto</i>	PMUCH41/CC	TBRA2L70	RUC41



Compatible with - *Compatible con* EUROTEKNIKA

Uneva (Platform Switching) - EUROTEKNIKA



	Platform <i>Plataforma</i>	Pre-milled abutment blank <i>Cilindro pre-fresado</i>	Straight screw <i>Tornillo recto</i>	Analog <i>Réplica</i>
Ø 4,8 Ø 6	Titanium <i>Titanio</i>	PMUCH41/TI	TBRA2L70	
	Cobalt-Chrome <i>Cromo Cobalto</i>	PMUCH41/CC	TBRA2L70	

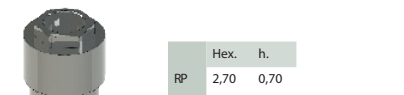

Natea - EUROTEKNIKA



RP	Titanium <i>Titanio</i>	PMASTHRP/TI	TAST16L82	RASTRP
	Cobalt-Chrome <i>Cromo Cobalto</i>	PMASTHRP/CC	TAST16L82	RASTRP
WP	Titanium <i>Titanio</i>	PMASTHWP/TI	TAST2L103	RASTWP
	Cobalt-Chrome <i>Cromo Cobalto</i>	PMASTHWP/CC	TAST2L103	RASTWP



Aesthetica - EUROTEKNIKA



RP	Titanium <i>Titanio</i>	PMSTO48/TI	TSTR2L67	ROC48
	Cobalt-Chrome <i>Cromo Cobalto</i>	PMSTO48/CC	TSTR2L67	ROC48



Naturall - EUROTEKNIKA



RP	Titanium <i>Titanio</i>	PMASTHRP/TI	TAST16L82	RASTRP
	Cobalt-Chrome <i>Cromo Cobalto</i>	PMASTHRP/CC	TAST16L82	RASTRP
WP	Titanium <i>Titanio</i>	PMASTHWP/TI	TAST2L103	RASTWP
	Cobalt-Chrome <i>Cromo Cobalto</i>	PMASTHWP/CC	TAST2L103	RASTWP



Compatible with - *Compatible con* GALIMPLANT

External Connection *Conexión Externa* - GALIMPLANT



Platform <i>Plataforma</i>	Pre-milled abutment blank <i>Cilindro pre-fresado</i>	Straight screw <i>Tornillo recto</i>	Analog <i>Réplica</i>
RP Titanium <i>Titanio</i>	PMUCH41/Ti	TBRA2L70	RUC41
Cobalt-Chrome <i>Cromo Cobalto</i>	PMUCH41/CC	TBRA2L70	RUC41



	Hex.	h.
RP	2,70	0,70

Internal Connection *Conexión Interna* - GALIMPLANT



RP Titanium <i>Titanio</i>	PMASTRP/Ti	TAST16L82	RASTRP
Cobalt-Chrome <i>Cromo Cobalto</i>	PMASTRP/CC	TAST16L82	RASTRP



Compatible with - *Compatible con* GMI

Phoenix - GMI



Platform <i>Plataforma</i>	Pre-milled abutment blank <i>Cilindro pre-fresado</i>	Straight screw <i>Tornillo recto</i>	Analog <i>Réplica</i>
RP Titanium <i>Titanio</i>	PMUCH41/Ti	TBRA2L70	RUC41
Cobalt-Chrome <i>Cromo Cobalto</i>	PMUCH41/CC	TBRA2L70	RUC41



	Hex.	h.
RP	2,70	0,70

Frontier - GMI



ST Titanium <i>Titanio</i>	PMZIMH35/Ti	TBTIL18L68	--
Cobalt-Chrome <i>Cromo Cobalto</i>	PMZIMH35/CC	TBTIL18L68	--
WP Titanium <i>Titanio</i>	PMZIMH45/Ti	TBTIL18L68	--
Cobalt-Chrome <i>Cromo Cobalto</i>	PMZIMH45/CC	TBTIL18L68	--



Compatible with - *Compatible con* GT MEDICAL

Best Fit Internal Octagon Best Fit Octógono Interno - GT MEDICAL



Platform <i>Plataforma</i>	Pre-milled abutment blank <i>Cilindro pre-fresado</i>	Straight screw <i>Tornillo recto</i>	Analog <i>Réplica</i>
RP Titanium <i>Titanio</i>	PMSTO48/TI	TSTR2L67	ROC48
Cobalt-Chrome <i>Cromo Cobalto</i>	PMSTO48/CC	TSTR2L67	ROC48



Best Fit Internal Hexagon Best Fit Hexágono Interno - GT MEDICAL



WP Titanium <i>Titanio</i>	PMASTHWP/TI	TAST2L103	RASTWP
Cobalt-Chrome <i>Cromo Cobalto</i>	PMASTHWP/CC	TAST2L103	RASTWP



Best Fit External Hexagon Hexágono Externo - GT MEDICAL



RP Titanium <i>Titanio</i>	PMUCH41/TI	TBRA2L70	RUC41
Cobalt-Chrome <i>Cromo Cobalto</i>	PMUCH41/CC	TBRA2L70	RUC41



RP	Hex.	h.
	2,70	0,70

Compatible with - *Compatible con* HI-TEC

Self Thread SLT - HI-TEC



Platform <i>Plataforma</i>	Pre-milled abutment blank <i>Cilindro pre-fresado</i>	Straight screw <i>Tornillo recto</i>	Analog <i>Réplica</i>
Ø 3,75 Titanium <i>Titanio</i>	PMZIMH35/TI	TZIML76	RZIM35
Cobalt-Chrome <i>Cromo Cobalto</i>	PMZIMH35/CC	TZIML76	RZIM35



Compatible with - *Compatible con* HI-TEC

Self Thread GTI - HI-TEC



Platform		Pre-milled abutment blank	Straight screw	Analog
<i>Plataforma</i>		<i>Cilindro pre-fresado</i>	<i>Tornillo recto</i>	<i>Réplica</i>
Ø 4,2	Titanium <i>Titanio</i>	PMZIMH45/TI	TZIML76	RZIM45
	Cobalt-Chrome <i>Cromo Cobalto</i>	PMZIMH45/CC	TZIML76	RZIM45



LGI Plus - HI-TEC



Ø 4,3	Titanium <i>Titanio</i>	PMZIMH35/TI	TZIML76	RZIM35
	Cobalt-Chrome <i>Cromo Cobalto</i>	PMZIMH35/CC	TZIML76	RZIM35



Compatible with - *Compatible con* IMBIODENT

Imbiodent - IMBIODENT



Platform		Pre-milled abutment blank	Straight screw	Analog
<i>Plataforma</i>		<i>Cilindro pre-fresado</i>	<i>Tornillo recto</i>	<i>Réplica</i>
RP	Titanium <i>Titanio</i>	PMBONHRP/TI	TBON16L79	RBONRP
	Cobalt-Chrome <i>Cromo Cobalto</i>	PMBONHRP/CC	TBON16L79	RBONRP



Compatible with - *Compatible con* IMPLANT DIRECT

RePlus / Replant / Reactive - IMPLANT DIRECT



Platform		Pre-milled abutment blank	Straight screw	Analog
<i>Plataforma</i>		<i>Cilindro pre-fresado</i>	<i>Tornillo recto</i>	<i>Réplica</i>
RP	Titanium <i>Titanio</i>	PMRPLT43/TI	TRPL2L100	RRPL43
	Cobalt-Chrome <i>Cromo Cobalto</i>	PMRPLT43/CC	TRPL2L100	RRPL43



Legacy - IMPLANT DIRECT



NP	Titanium <i>Titanio</i>	PMZIMH35/TI	TZIML76	RZIM35
	Cobalt-Chrome <i>Cromo Cobalto</i>	PMZIMH35/CC	TZIML76	RZIM35
RP	Titanium <i>Titanio</i>	PMZIMH45/TI	TZIML76	RZIM45
	Cobalt-Chrome <i>Cromo Cobalto</i>	PMZIMH45/CC	TZIML76	RZIM45



Swishplant / Swishplus - IMPLANT DIRECT



RP	Titanium <i>Titanio</i>	PMSTO48/TI	TSTR2L67	ROC48
	Cobalt-Chrome <i>Cromo Cobalto</i>	PMSTO48/CC	TSTR2L67	ROC48



Interactive - IMPLANT DIRECT



RP	Titanium <i>Titanio</i>	PMACTHRP/TI	TACT2L73	RACTRP
	Cobalt-Chrome <i>Cromo Cobalto</i>	PMACTHRP/CC	TACT2L73	RACTRP



Compatible with - *Compatible con* JDENTALCARE

JDEvolution - JDENTALCARE



Platform	Pre-milled abutment blank	Straight screw	Analog
<i>Plataforma</i>	<i>Cilindro pre-fresado</i>	<i>Tornillo recto</i>	<i>Réplica</i>
Ø 3,7 Ø 4,3 Ø 5 Ø 6	PMZIMH35/Ti	TZIML76	RZIM35
Titanium Titanio			
Cobalt-Chrome Cromo Cobalto	PMZIMH35/CC	TZIML76	RZIM35



Compatible with - *Compatible con* KEYSTON

Restore - KEYSTON



Platform	Pre-milled abutment blank	Straight screw	Analog
<i>Plataforma</i>	<i>Cilindro pre-fresado</i>	<i>Tornillo recto</i>	<i>Réplica</i>
RP	PMUCH41/Ti	TBRA2L70	RUC41
Titanium Titanio			
Cobalt-Chrome Cromo Cobalto	PMUCH41/CC	TBRA2L70	RUC41



RP	Hex.	h.
	2,70	0,70

Compatible with - *Compatible con* KLOCKNER

KL - KLOCKNER



Platform	Pre-milled abutment blank	Straight screw	Analog
<i>Plataforma</i>	<i>Cilindro pre-fresado</i>	<i>Tornillo recto</i>	<i>Réplica</i>
RP	PMUCH41/Ti	TBRA2L70	RUC41
Titanium Titanio			
Cobalt-Chrome Cromo Cobalto	PMUCH41/CC	TBRA2L70	RUC41



RP	Hex.	h.
	2,70	0,70

Compatible with - *Compatible con* LEADER

Tixos Internal Hex Hexágono Interno - LEADER



Platform <i>Plataforma</i>	Pre-milled abutment blank <i>Cilindro pre-fresado</i>	Straight screw <i>Tornillo recto</i>	Analog <i>Réplica</i>	
Ø 3.5 Ø 4	Titanium <i>Titanio</i>	PMZIMH35/TI	TZIML76	RZIM35
	Cobalt-Chrome <i>Cromo Cobalto</i>	PMZIMH35/CC	TZIML76	RZIM35



Tixos External Hex Hexágono Externo - LEADER



RP	Titanium <i>Titanio</i>	PMUCH41/TI	TBRA2L70	RUC41
	Cobalt-Chrome <i>Cromo Cobalto</i>	PMUCH41/CC	TBRA2L70	RUC41



	Hex.	h.
RP	2,70	0,70

Compatible with - *Compatible con* MEGAGEN

Anyone External - MEGAGEN



Platform <i>Plataforma</i>	Pre-milled abutment blank <i>Cilindro pre-fresado</i>	Straight screw <i>Tornillo recto</i>	Analog <i>Réplica</i>	
RP	Titanium <i>Titanio</i>	PMUCH41/TI	TBRA2L70	RUC41
	Cobalt-Chrome <i>Cromo Cobalto</i>	PMUCH41/CC	TBRA2L70	RUC41



	Hex.	h.
RP	2,70	0,70

Compatible with - *Compatible con* MICRODENT

Universal - MICRODENT



Platform <i>Plataforma</i>	Pre-milled abutment blank <i>Cilindro pre-fresado</i>	Straight screw <i>Tornillo recto</i>	Analog <i>Réplica</i>
RP Titanium <i>Titanio</i>	PMUCH41/Ti	TBRA2L70	RUC41
Cobalt-Chrome <i>Cromo Cobalto</i>	PMUCH41/CC	TBRA2L70	RUC41



Ektos - MICRODENT



Ø 3,5 Titanium <i>Titanio</i>	PMZIMH35/Ti	TZIML76	RZIM35
Cobalt-Chrome <i>Cromo Cobalto</i>	PMZIMH35/CC	TZIML76	RZIM35



Compatible with - *Compatible con* MIS

Lance - MIS



Platform <i>Plataforma</i>	Pre-milled abutment blank <i>Cilindro pre-fresado</i>	Straight screw <i>Tornillo recto</i>	Analog <i>Réplica</i>
RP Titanium <i>Titanio</i>	PMUCH41/Ti	TBRA2L70	RUC41
Cobalt-Chrome <i>Cromo Cobalto</i>	PMUCH41/CC	TBRA2L70	RUC41



Seven - MIS



ST Titanium <i>Titanio</i>	PMZIMH35/Ti	TZIML76	RZIM35
Cobalt-Chrome <i>Cromo Cobalto</i>	PMZIMH35/CC	TZIML76	RZIM35
WP Titanium <i>Titanio</i>	PMZIMH45/Ti	TZIML76	RZIM45
Cobalt-Chrome <i>Cromo Cobalto</i>	PMZIMH45/CC	TZIML76	RZIM45



Compatible with - *Compatible con* MIS

M4 - MIS



	Platform <i>Plataforma</i>	Pre-milled abutment blank <i>Cilindro pre-fresado</i>	Straight screw <i>Tornillo recto</i>	Analog <i>Réplica</i>
ST	Titanium <i>Titanio</i>	PMZIMH35/TI	TZIML76	RZIM35
	Cobalt-Chrome <i>Cromo Cobalto</i>	PMZIMH35/CC	TZIML76	RZIM35
WP	Titanium <i>Titanio</i>	PMZIMH45/TI	TZIML76	RZIM45
	Cobalt-Chrome <i>Cromo Cobalto</i>	PMZIMH45/CC	TZIML76	RZIM45



Compatible with - *Compatible con* MOZO-GRAU

MG Osseous - MOZO-GRAU



	Platform <i>Plataforma</i>	Pre-milled abutment blank <i>Cilindro pre-fresado</i>	Straight screw <i>Tornillo recto</i>	Analog <i>Réplica</i>
RP	Titanium <i>Titanio</i>	PMUCH41/TI	TBRA2L70	RUC41
	Cobalt-Chrome <i>Cromo Cobalto</i>	PMUCH41/CC	TBRA2L70	RUC41



	Hex.	h.
RP	2,70	0,70

MG Inhex - MOZO-GRAU



RP	Titanium <i>Titanio</i>	PMASTHRP/TI	TAST16L82	RASTRP
	Cobalt-Chrome <i>Cromo Cobalto</i>	PMASTHRP/CC	TAST16L82	RASTRP
WP	Titanium <i>Titanio</i>	PMASTHWP/TI	TAST2L103	RASTWP
	Cobalt-Chrome <i>Cromo Cobalto</i>	PMASTHWP/CC	TAST2L103	RASTWP



Compatible with - *Compatible con* MPI

External Connection HE Conexión Externa HE - MPI



Platform <i>Plataforma</i>		Pre-milled abutment blank <i>Cilindro pre-fresado</i>	Straight screw <i>Tornillo recto</i>	Analog <i>Réplica</i>
RP	Titanium <i>Titanio</i>	PMUCH41/TI	TBRA2L70	RUC41
	Cobalt-Chrome <i>Cromo Cobalto</i>	PMUCH41/CC	TBRA2L70	RUC41



Internal Connection CM Conexión Interna CM - MPI



RP	Titanium <i>Titanio</i>	PMASTHRP/TI	TAST16L82	RASTRP
	Cobalt-Chrome <i>Cromo Cobalto</i>	PMASTHRP/CC	TAST16L82	RASTRP
WP	Titanium <i>Titanio</i>	PMASTHWP/TI	TAST2L103	RASTWP
	Cobalt-Chrome <i>Cromo Cobalto</i>	PMASTHWP/CC	TAST2L103	RASTWP



Compatible with - *Compatible con* NEODENT

Smart HE - NEODENT



Platform <i>Plataforma</i>		Pre-milled abutment blank <i>Cilindro pre-fresado</i>	Straight screw <i>Tornillo recto</i>	Analog <i>Réplica</i>
RP Ø 4,1	Titanium <i>Titanio</i>	PMUCH41/TI	TBRA2L70	RUC41
	Cobalt-Chrome <i>Cromo Cobalto</i>	PMUCH41/CC	TBRA2L70	RUC41

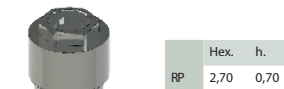

Compatible with - *Compatible con* NOBEL BIOCARE

Branemark - NOBEL BIOCARE



Platform <i>Plataforma</i>		Pre-milled abutment blank <i>Cilindro pre-fresado</i>	Straight screw <i>Tornillo recto</i>	Analog <i>Réplica</i>
RP	Titanium <i>Titanio</i>	PMUCH41/Ti	TBRA2L70	RUC41
	Cobalt-Chrome <i>Cromo Cobalto</i>	PMUCH41/CC	TBRA2L70	RUC41



Replace - NOBEL BIOCARE



RP	Titanium <i>Titanio</i>	PMRPLT43/Ti	TRPL2L100	RRPL43
	Cobalt-Chrome <i>Cromo Cobalto</i>	PMRPLT43/CC	TRPL2L100	RRPL43



Active - NOBEL BIOCARE



RP	Titanium <i>Titanio</i>	PMACTHRP/Ti	TACT2L73	RACTRP
	Cobalt-Chrome <i>Cromo Cobalto</i>	PMACTHRP/CC	TACT2L73	RACTRP



Compatible with - *Compatible con* OSSEOLIFE

OEX - OSSEOLIFE



Platform <i>Plataforma</i>		Pre-milled abutment blank <i>Cilindro pre-fresado</i>	Straight screw <i>Tornillo recto</i>	Analog <i>Réplica</i>
RP	Titanium <i>Titanio</i>	PMUCH41/Ti	TBRA2L70	RUC41
	Cobalt-Chrome <i>Cromo Cobalto</i>	PMUCH41/CC	TBRA2L70	RUC41



Compatible with - *Compatible con* OSSTEM IMPLANT

US - OSSTEM IMPLANT



Platform	Pre-milled abutment blank	Straight screw	Analog
<i>Plataforma</i>	<i>Cilindro pre-fresado</i>	<i>Tornillo recto</i>	<i>Réplica</i>
RP Titanium <i>Titanio</i>	PMUCH41/Ti	TBRA2L70	RUC41
Cobalt-Chrome <i>Cromo Cobalto</i>	PMUCH41/CC	TBRA2L70	RUC41



RP	Hex.	h.
	2,70	0,70

Compatible with - *Compatible con* OSTEOPLUS

She - OSTEOPLUS



Platform	Pre-milled abutment blank	Straight screw	Analog
<i>Plataforma</i>	<i>Cilindro pre-fresado</i>	<i>Tornillo recto</i>	<i>Réplica</i>
RP Titanium <i>Titanio</i>	PMUCH41/Ti	TBRA2L70	RUC41
Cobalt-Chrome <i>Cromo Cobalto</i>	PMUCH41/CC	TBRA2L70	RUC41



RP	Hex.	h.
	2,70	0,70

Shi - OSTEOPLUS



Ø 3,5	Titanium <i>Titanio</i>	PMZIMH35/Ti	TZIML76	RZIM35
	Cobalt-Chrome <i>Cromo Cobalto</i>	PMZIMH35/CC	TZIML76	RZIM35



Compatible with - *Compatible con* PHIBO

TSH/BTN Serie 3 - PHIBO



Platform	Pre-milled abutment blank	Straight screw	Analog
<i>Plataforma</i>	<i>Cilindro pre-fresado</i>	<i>Tornillo recto</i>	<i>Réplica</i>
RP Titanium <i>Titanio</i>	PMUCH41/Ti	TBRA2L70	RUC41
Cobalt-Chrome <i>Cromo Cobalto</i>	PMUCH41/CC	TBRA2L70	RUC41



TSH/BTN Serie 4 - PHIBO



RP Titanium <i>Titanio</i>	PMUCH41/Ti	TBRA2L70	RUC41
Cobalt-Chrome <i>Cromo Cobalto</i>	PMUCH41/CC	TBRA2L70	RUC41



Compatible with - *Compatible con* PROCLINIC

External Connection Conexión Externa - PROCLINIC



Platform	Pre-milled abutment blank	Straight screw	Analog
<i>Plataforma</i>	<i>Cilindro pre-fresado</i>	<i>Tornillo recto</i>	<i>Réplica</i>
RP Titanium <i>Titanio</i>	PMUCH41/Ti	TBRA2L70	RUC41
Cobalt-Chrome <i>Cromo Cobalto</i>	PMUCH41/CC	TBRA2L70	RUC41



Compatible with - *Compatible con* PROCLINIC

Internal Hexagon Hexágono Interno - PROCLINIC



Platform		Pre-milled abutment blank	Straight screw	Analog
<i>Plataforma</i>		<i>Cilindro pre-fresado</i>	<i>Tornillo recto</i>	<i>Réplica</i>
NP	Titanium <i>Titanio</i>	PMZIMH35/TI	TZIML76	RZIM35
	Cobalt-Chrome <i>Cromo Cobalto</i>	PMZIMH35/CC	TZIML76	RZIM35
RP	Titanium <i>Titanio</i>	PMZIMH45/TI	TZIML76	RZIM45
	Cobalt-Chrome <i>Cromo Cobalto</i>	PMZIMH45/CC	TZIML76	RZIM45



Internal Octagon Octógono Interno - PROCLINIC



RP	Titanium <i>Titanio</i>	PMSTO48/TI	TSTR2L67	ROC48
	Cobalt-Chrome <i>Cromo Cobalto</i>	PMSTO48/CC	TSTR2L67	ROC48



Compatible with - *Compatible con* RADHEX

PHE - RADHEX



Platform		Pre-milled abutment blank	Straight screw	Analog
<i>Plataforma</i>		<i>Cilindro pre-fresado</i>	<i>Tornillo recto</i>	<i>Réplica</i>
RP	Titanium <i>Titanio</i>	PMUCH41/TI	TBRA2L70	RUC41
	Cobalt-Chrome <i>Cromo Cobalto</i>	PMUCH41/CC	TBRA2L70	RUC41



	Hex.	h.
RP	2,70	0,70

Compatible with - *Compatible con* RADHEX

PHI - RADHEX



Platform <i>Plataforma</i>	Pre-milled abutment blank <i>Cilindro pre-fresado</i>	Straight screw <i>Tornillo recto</i>	Analog <i>Réplica</i>
NP Titanium <i>Titanio</i> Cobalt-Chrome <i>Cromo Cobalto</i>	PMZIMH35/Ti	TBTIL18L68	--
	PMZIMH35/CC	TBTIL18L68	--
RP Titanium <i>Titanio</i> Cobalt-Chrome <i>Cromo Cobalto</i>	PMZIMH45/Ti	TZIML76	RZIM45
	PMZIMH45/CC	TZIML76	RZIM45



Compatible with - *Compatible con* SGS

P1 - SGS



Platform <i>Plataforma</i>	Pre-milled abutment blank <i>Cilindro pre-fresado</i>	Straight screw <i>Tornillo recto</i>	Analog <i>Réplica</i>
Ø 3,2 Ø 3,75 Ø 4,2 Ø 5 Ø 6 Titanium <i>Titanio</i> Cobalt-Chrome <i>Cromo Cobalto</i>	PMZIMH35/Ti	TZIML76	RZIM35
	PMZIMH35/CC	TZIML76	RZIM35



P7 - SGS



Ø 3,2 Ø 3,75 Ø 4,2 Ø 4,5 Ø 5 Ø 6 Titanium <i>Titanio</i> Cobalt-Chrome <i>Cromo Cobalto</i>	PMZIMH35/Ti	TZIML76	RZIM35
	PMZIMH35/CC	TZIML76	RZIM35



Compatible with - *Compatible con* SIGNO VINCES

Duo - SIGNO VINCES



Platform		Pre-milled abutment blank	Straight screw	Analog
<i>Plataforma</i>		<i>Cilindro pre-fresado</i>	<i>Tornillo recto</i>	<i>Réplica</i>
RP	Titanium <i>Titanio</i>	PMUCH41/Ti	TBRA2L70	RUC41
	Cobalt-Chrome <i>Cromo Cobalto</i>	PMUCH41/CC	TBRA2L70	RUC41



Integra - SIGNO VINCES



RP	Titanium <i>Titanio</i>	PMUCH41/Ti	TBRA2L70	RUC41
	Cobalt-Chrome <i>Cromo Cobalto</i>	PMUCH41/CC	TBRA2L70	RUC41



Compact 4,5 - SIGNO VINCES



Ø 3,8	Titanium <i>Titanio</i>	PMASTHWP/Ti	TAST2L103	RASTWP
	Cobalt-Chrome <i>Cromo Cobalto</i>	PMASTHWP/CC	TAST2L103	RASTWP



Duocon 3,8 - SIGNO VINCES



Ø 3,8	Titanium <i>Titanio</i>	PMASTHWP/Ti	TAST2L103	RASTWP
	Cobalt-Chrome <i>Cromo Cobalto</i>	PMASTHWP/CC	TAST2L103	RASTWP



Compatible with - *Compatible con* STRAUMANN

Internal Octagon *Octógono Interno* - STRAUMANN



Platform	Pre-milled abutment blank	Straight screw	Analog
<i>Plataforma</i>	<i>Cilindro pre-fresado</i>	<i>Tornillo recto</i>	<i>Réplica</i>
RP Titanium <i>Titanio</i>	PMSTO48/TI	TSTR2L67	ROC48
Cobalt-Chrome <i>Cromo Cobalto</i>	PMSTO48/CC	TSTR2L67	ROC48



Bone Level - STRAUMANN



RC Ø 4,1	Titanium <i>Titanio</i>	PMBONHRP/TI	TBON16L79	RBNRP
Ø 4,8	Cobalt-Chrome <i>Cromo Cobalto</i>	PMBONHRP/CC	TBON16L79	RBNRP



Compatible with - *Compatible con* SYBRON IMPLANT SOLUTIONS

Endopore (Innova) - SYBRON IMPLANT SOLUTIONS



Platform	Pre-milled abutment blank	Straight screw	Analog
<i>Plataforma</i>	<i>Cilindro pre-fresado</i>	<i>Tornillo recto</i>	<i>Réplica</i>
RP Titanium <i>Titanio</i>	PMUCH41/TI	TBRA2L70	RUC41
Cobalt-Chrome <i>Cromo Cobalto</i>	PMUCH41/CC	TBRA2L70	RUC41



RP	Hex.	h.
	2,70	0,70

Compatible with - *Compatible con* TITANIUM-FIX

b-fix - TITANIUM-FIX



Platform	Pre-milled abutment blank	Straight screw	Analog
<i>Plataforma</i>	<i>Cilindro pre-fresado</i>	<i>Tornillo recto</i>	<i>Réplica</i>
RP Titanium <i>Titanio</i>	PMASTHRP/Ti	TAST16L82	RASTRP
Cobalt-Chrome <i>Cromo Cobalto</i>	PMASTHRP/CC	TAST16L82	RASTRP
WP Titanium <i>Titanio</i>	PMASTHWP/Ti	TAST2L103	RASTWP
Cobalt-Chrome <i>Cromo Cobalto</i>	PMASTHWP/CC	TAST2L103	RASTWP



Compatible with - *Compatible con* TRI DENTAL IMPLANTS

TRI-Vent - TRI DENTAL IMPLANTS



Platform	Pre-milled abutment blank	Straight screw	Analog
<i>Plataforma</i>	<i>Cilindro pre-fresado</i>	<i>Tornillo recto</i>	<i>Réplica</i>
Ø 3,5 Titanium <i>Titanio</i>	PMZIOH35/Ti	TZIML76	RZIM35
Cobalt-Chrome <i>Cromo Cobalto</i>	PMZIOH35/CC	TZIML76	RZIM35



Compatible with - *Compatible con* TRINON

Q2 Hexágono Externo - TRINON



Platform	Pre-milled abutment blank	Straight screw	Analog
<i>Plataforma</i>	<i>Cilindro pre-fresado</i>	<i>Tornillo recto</i>	<i>Réplica</i>
RP Titanium <i>Titanio</i>	PMUCH41/Ti	TBRA2L70	RUC41
Cobalt-Chrome <i>Cromo Cobalto</i>	PMUCH41/CC	TBRA2L70	RUC41



	Hex.	h.
RP	2,70	0,70

Compatible with - *Compatible con* TRINON

QK Octógono Interno - TRINON



Platform		Pre-milled abutment blank	Straight screw	Analog
<i>Plataforma</i>		<i>Cilindro pre-fresado</i>	<i>Tornillo recto</i>	<i>Réplica</i>
RP	Titanium <i>Titanio</i>	PMSTO48/Ti	TSTR2L67	ROC48
	Cobalt-Chrome <i>Cromo Cobalto</i>	PMSTO48/CC	TSTR2L67	ROC48



Compatible with - *Compatible con* ZIMMER

Screw-Vent - ZIMMER



Platform		Pre-milled abutment blank	Straight screw	Analog
<i>Plataforma</i>		<i>Cilindro pre-fresado</i>	<i>Tornillo recto</i>	<i>Réplica</i>
NP	Titanium <i>Titanio</i>	PMZIOH35/Ti	TZIML76	RZIM35
	Cobalt-Chrome <i>Cromo Cobalto</i>	PMZIOH35/CC	TZIML76	RZIM35
RP	Titanium <i>Titanio</i>	PMZIOH45/Ti	TZIML76	RZIM45
	Cobalt-Chrome <i>Cromo Cobalto</i>	PMZIOH45/CC	TZIML76	RZIM45



Swiss-Plus - ZIMMER



RP	Titanium <i>Titanio</i>	PMSTO48/Ti	TSTR2L67	ROC48
	Cobalt-Chrome <i>Cromo Cobalto</i>	PMSTO48/CC	TSTR2L67	ROC48



PRE-MILLED BLANK GRIPS

SOPORTES PARA CILINDROS PRE-FRESADOS

GRIP FOR 98mm DISC
SOPORTE PARA DISCO 98mm

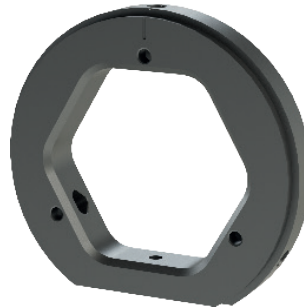

REFERENCE
REFERENCIA
SPD98V3

DISC ADAPTER
ADAPTADOR PARA DISCO

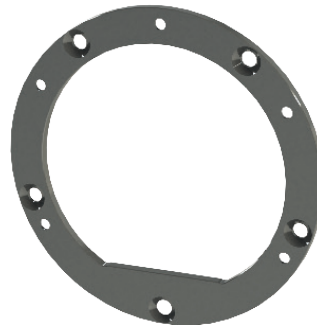

REFERENCE
REFERENCIA
ANETD98

CNC GRIP
SOPORTE CNC



REFERENCE
REFERENCIA
SPC10V

Tornillos Dinámicos



	REFERENCIA	MÉTRICA	TORQUE	LONGITUD TOTAL	LONG. ROSCA	DIAM. CABEZA	LONGITUD A	LONGITUD B	LONGITUD C	ASENTAMIENTO	ÁNGULO	ENTRADA ROSCA	CONEXIÓN
	TPDH14L39	1,4	15 N-cm	3,90	1,80	2,40	2,10	-	1,80	recto	-	Chaflán 45°	Hexalobular 1,70
	TPDH14	1,4	15 N-cm	4	1,85	-	2	2,78	1,22	cónico	30°	Chaflán 45°	
	TPDHST	1,4	15 N-cm	4,5	2,3	2,30	2,5	3,28	1,22	cónico	30°	Chaflán 45°	
	TPDH14L52	1,4	15 N-cm	5,20	2,90	2,30	3,40	-	1,80	recto	-	Chaflán 45°	
	TPDH14L67	1,4	15 N-cm	6,70	2,31	2,30	5,00	5,45	1,25	cónico	45°	Chaflán 45°	
	TPDH14L74	1,4	15 N-cm	7,40	3,55	2,30	5,00	5,99	1,41	cónico	25°	Chaflán 45°	
	TPDH16	1,6	20 N-cm	4,4	2,5	2,30	2,9	-	1,5	recto	-	Semiesferica	
	TPDH16L6	1,6	20 N-cm	5,9	3	2,30	4,4	-	1,5	recto	-	Semiesferica	
	TPDH16L71	1,6	20 N-cm	7,10	2,80	2,30	5,20	5,53	1,57	cónico	60°	Chaflán 45°	
	TPDH16L72	1,6	20 N-cm	7,2	3,5	2,30	5,2	5,85	1,35	cónico	30°	Chaflán 45°	
	TPDH16L73	1,6	20 N-cm	7,3	2,2	2,30	4,87	5,56	1,74	cónico	35°	Chaflán 45°	
	TPDH16L76	1,6	20 N-cm	7,6	3,6	2,30	6,1	-	1,5	recto	-	Semiesferica	
	TPDH16L78	1,6	20 N-cm	7,8	2	2,30	5,36	7,03	0,81	cónico	15°	Chaflán 45°	
	TPDH16L81	1,6	20 N-cm	8,10	3,00	2,30	6,35	6,72	1,38	cónico	45°	Chaflán 45°	
	TPDH16L84	1,6	20 N-cm	8,4	3,5	2,30	6,8	-	1,6	recto	-	Semiesferica	
	TPDH16L94	1,6	20 N-cm	9,40	2,90	2,30	7,65	8,00	1,40	cónico	45°	Chaflán 45°	
	TPDH17L71	N1-72	25 N-cm	7,1	2,6	2,30	5,56	5,65	1,45	cónico	70°	Chaflán 45°	
	TPDH17L73	N1-72	25 N-cm	7,30	2,50	2,30	5,50	5,77	1,53	cónico	60	Chaflán 45°	
	TPDH18	1,8	25 N-cm	4,4	2,75	2,30	3	-	1,4	recto	-	Semiesferica	
	TPDH18L45	1,8	25 N-cm	4,50	2,30	2,30	2,81	2,90	1,60	cónico	70°	Chaflán 45°	
	TPDH18L48	1,8	25 N-cm	4,8	2,8	2,30	3,22	3,65	1,15	cónico	30°	Semiesferica	
	TPDH18L65	1,8	25 N-cm	6,50	2,80	2,30	5,00	-	1,50	recto	-	Semiesferica	
	TPDH18L74	1,8	25 N-cm	7,4	3,8	2,30	5,8	6,03	1,6	cónico	50°	Chaflán 45°	



	REFERENCIA	MÉTRICA	TORQUE	LONGITUD TOTAL	LONG. ROSCA	DIÁM. CABEZA	LONGITUD A	LONGITUD B	LONGITUD C	ASENTAMIENTO	ÁNGULO	ENTRADA ROSCA	CONEXIÓN
	TPDH18L75	1,8	25 N-cm	7,5	3,3	2,30	6,1	-	1,4	recto	-	Semiesférica	Hexalobular 1,70
	TPDH18L80	1,8	25 N-cm	8,00	4,00	2,30	6,50	-	1,50	recto	-	Chaflán 45°	
	TPDH2	2	25 N-cm	4,7	3	2,30	3,3	-	1,4	recto	-	Semiesférica	
	TPDH2L5	2	25 N-cm	5	2,8	2,30	3,39	3,6	1,4	cónico	30°	Semiesférica	
	TPDH2L51	2	25 N-cm	5,1	3,1	2,30	3,6	-	1,5	recto	-	Semiesférica	
	TPDH2L6	2	25 N-cm	6	2,7	2,30	4,5	-	1,5	recto	-	Semiesférica	
	TPDH2L65	2	25 N-cm	6,5	2,7	2,30	5	-	1,5	recto	-	Chaflán 45°	
	TPDH2L67	2,0	25 N-cm	6,70	2,30	2,58	3,65	5,68	1,02	cónico	15°	Chaflán 45°	
	TPDH2L70	2,0	25 N-cm	7,00	3,00	2,30	5,60	-	1,40	recto	-	Semiesférica	
	TPDH2L74	2	25 N-cm	7,4	3,3	2,30	6	-	1,4	recto	-	Semiesférica	
	TPDH2L75	2	25 N-cm	7,5	2,75	2,30	5,93	6,18	1,32	cónico	35°	Chaflán 45°	
	TPDH2L79	2,0	25 N-cm	7,90	3,30	2,30	6,33	6,50	1,40	cónico	45°	Chaflán 45°	
	TPDH2L82	2	25 N-cm	8,2	4,7	2,4	6,7	-	1,5	recto	-	Semiesférica	
	TPDH2L90	2,0	25 N-cm	9,00	4,00	2,30	7,50	-	1,50	recto	-	Semiesférica	
	TPDH25	2,5	25 N-cm	5,4	3,8	2,85	4,1	-	1,3	recto	-	Semiesférica	
	TPDH25L67	2,5	25 N-cm	6,7	4,6	2,85	5,1	-	1,6	recto	-	Semiesférica	







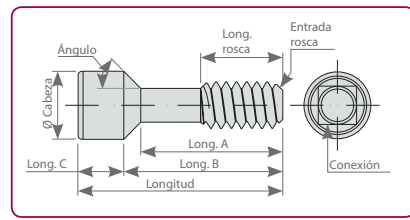
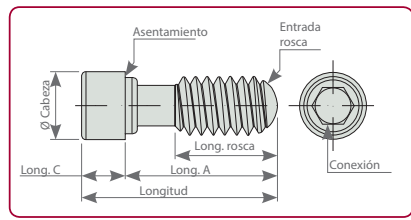















Destornillador Dinámico

















DSPDCLH-18: PD 18mm
 DSPDCLH-24: PD 24mm
 DSPDCLH-32: PD 32mm



Tornillos Rectos

	REFERENCIA	MÉTRICA	TORQUE	LONGITUD TOTAL	LONG. ROSCA	LONGITUD A	LONGITUD B	LONGITUD C	DIAM. CABEZA	ASENTAMIENTO	ÁNGULO	ENTRADA ROSCA	CONEXIÓN
	TMU14L35	1,4	15 N-cm	3,5	1,8	2,1	-	1,4	2	recto	-	Chaflán 45°	Unigrip
	TST	1,4	15 N-cm	3,9	1,91	2,1	-	1,8	2,4	recto	-	Chaflán 45°	Hex. 1,20
	TCO	1,4	15 N-cm	4	2	2,2	-	1,8	2,3	recto	-	Chaflán 45°	Hex. 1,20
	TUC16	1,6	20 N-cm	7	2,79	4,86	5,44	1,56	2,3	cónico	45°	Chaflán 45°	Cuad. 1,30
	TBRA16L70	1,6	20 N-cm	7	2,7	5,15	-	1,8	2,3	recto	-	Chaflán 45°	Unigrip
	TACT16L73	1,6	20 N-cm	7,3	2,7	5,15	5,9	1,4	2,2	cónico	35°	Chaflán 45°	Unigrip
	TEV16L75	1,6	20 N-cm	7,5	7,5	5,33	5,85	1,65	2,15	cónico	30°	Chaflán 45°	Hex. 1,27
	TBN16L79	1,6	20 N-cm	7,9	2	5,72	6,9	2,18	2,18	cónico	15°	Chaflán 45°	Torx T6
	TAST16L82	1,6	20 N-cm	8,2	3,03	6,25	-	2	2,33	recto	-	Chaflán 45°	Hex. 1,27
	T3I16L84	1,6	20 N-cm	8,4	2,5	6,6	-	1,8	2	recto	-	Chaflán 45°	Hex. 1,20
	T3I	1,6	20 N-cm	9,3	3,3	7,3	-	2	2,3	recto	-	Semiesférica	Cuad. 1,30
	TCAM16L105	1,6	20 N-cm	10,5	2,9	8,15	8,4	2,1	2,1	cónico	45°	Chaflán 45°	Hex. 1,27
	TZIML76	N1-72	25 N-cm	7,6	2,8	5,6	5,76	1,84	2,3	cónico	70°	Chaflán 45°	Hex. 1,27
	TZIM	N1-72	25 N-cm	8,17	3	5,31	5,87	2,3	2,4	cónico	45°	Chaflán 45°	Cuad. 1,30
	TEV18L45	1,8	25 N-cm	4,5	2,3	2,8	2,9	1,6	2,35	cónico	70°	Chaflán 45°	Hex. 1,27
	TKL	1,8	25 N-cm	6	3,18	3,5	3,85	2,15	2,4	cónico	45°	Chaflán 45°	Hex. 1,50
	TBTI18L68	1,8	25 N-cm	6,8	3,3	5,2	-	1,6	2,3	recto	-	Chaflán 45°	Hex. 1,20
	TBTI	1,8	25 N-cm	7	3,2	5,2	-	1,8	2,5	recto	-	Chaflán 45°	Cuad. 1,30
	TECKALL125	1,8	25 N-cm	7,2	4,47	2,3	6,2	1	2,4	cónico	30°	Chaflán 45°	Hex. 1,25
	TEV18L76	1,8	25 N-cm	7,6	3,8	5,8	6,05	1,55	2,35	cónico	50°	Chaflán 45°	Hex. 1,27
	TRPL18L83	1,8	25 N-cm	8,3	2,5	6,5	-	1,8	2,45	recto	45°	Chaflán 45°	Unigrip
	TECKDU 125	1,8	25 N-cm	9,8	5,094	8,3	8,8	1	2,4	cónico	30°	Chaflán 45°	Hex. 1,25

	REFERENCIA	MÉTRICA	TORQUE	LONGITUD TOTAL	LONG. ROSCA	LONGITUD A	LONGITUD B	LONGITUD C	DIÁM. CABEZA	ASENTAMIENTO	ÁNGULO	ENTRADA ROSCA	CONEXIÓN
	TRPL35	1,8	25 N-cm	10,2	3,15	8,4	-	1,8	2,45	recto	-	Chaflán 45°	Cuad. 1,30
	TBTI2L47	2	30 N-cm	4,7	2,7	3,33	-	1,37	2,35	recto	-	Chaflán 45°	Hex. 1,20
	TSYN48	2	30 N-cm	5	3,06	3,26	3,5	1,5	2,49	cónico	45°	Chaflán 45°	Cuad. 1,30
	TSTR2L67	2	30 N-cm	6,7	2,25	3,59	5,7	1	2,58	cónico	15°	Chaflán 45°	Torx T6
	T3I2L70	2	30 N-cm	7	3,25	5	-	2	2,4	recto	-	Chaflán 45°	Hex. 1,20
	TBRA2L70	2	30 N-cm	7	3,25	5	-	2	2,4	recto	-	Chaflán 45°	Unigrip
	TACT2L73	2	30 N-cm	7,3	3	5,8	6,2	1,1	2,5	cónico	35°	Chaflán 45°	Unigrip
	TDSM2L74	2	30 N-cm	7,4	3,3	6	-	1,4	2,3	recto	-	Semiesférica	Torx T6
	TUC	2	30 N-cm	7,4	3,34	5,1	5,6	1,8	2,4	cónico	45°	Chaflán 45°	Hex. 1,20
	TSTR2L76	2	30 N-cm	7,6	3	6,1	6,3	1,3	2,4	cónico	45°	Semiesférica	Torx T6
	TRPL2L100	2	30 N-cm	10	3,6	8,5	-	1,5	2,45	recto	-	Chaflán 45°	Unigrip
	TRPL	2	30 N-cm	10,2	3,15	8,4	-	1,8	2,45	recto	-	Chaflán 45°	Cuad. 1,30
	TAST2L103	2	30 N-cm	10,3	3,5	8,3	-	2	2,33	recto	-	Chaflán 45°	Hex. 1,27
	TUC25	2,5	30 N-cm	7,41	3,5	4,75	5,29	2,12	2,87	cónico	45°	Semiesférica	Cuad. 1,30

Destornilladores Pilares Mecanizados



CLDES 1.20
Hex 1.20mm



CLDES 1.27
Hex. 1.27mm



CLDES 1.30
Cuad. 1.30mm



CLDESMNUG
Unigrip



CLDES 1.25
Hex 1.25mm



DESLCTORX
25mm

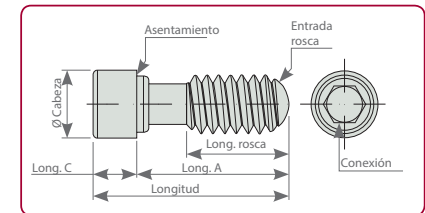
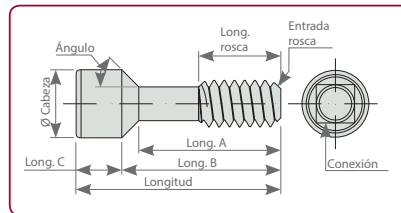



DYNAMIC
ABUTMENT®
SOLUTIONS



Talladium
International **Implantology**

AV. BLONDEL, 54 3º · 25002 · LLEIDA (SPAIN)

TEL. +34 973 289 580

International: das@dynamicabutment.com

España: spain@dynamicabutment.com

www.dynamicabutment.es

Dynamic Abutment® Solutions es la marca comercial del fabricante Talladium España S.L

DYNAMIC ABUTMENT® SOLUTIONS